

USER'S GUIDE

B8300

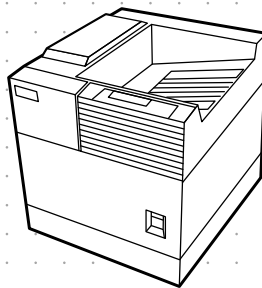

CONTENTS

Warranty	5
Trademark Acknowledgments	5
Before you do anything please read this	6
Installation requirements	6
Moving the machine	7
General warnings	8
Laser cautions.	9
Overview	11
Introduction.	11
Original and paper sizes.	11
Main Features	12
Energy saving features	12
Part Names and Functions	13
Exterior	13
Interior	14
Part names and functions.	15
Peripheral devices.	15
Operation panel of the main unit	17
Menu group and Key explanations	
main unit operation panel	18
Cancelling a print job and deleting print data.	19
To delete print data of a reserved job	
(jobs stored in the printer)	19
Loading Paper	20
Loading paper in paper tray 1	20
Changing the paper size in paper tray 1.	20
Specifications of paper trays	21
Applicable plain paper	22
Applicable special paper	22
Setting the paper size and type from the operation panel on the main printer	23
Loading paper in the multi-purpose drawer	24
Fusing unit pressure adjusting levers	25
Loading transparency film	26
Loading paper in the stand/3 x 500 sheet paper drawer	26
Loading paper in the stand/MPD and 2000 sheet paper drawer	27
Storage of supplies.	28
Supply list	28
Adding toner	29
Developer cartridge replacement.	31
Printing from a computer	33
Connecting this machine as a local printer	33
Software for Windows.	33
Installing printer drivers and utilities	34
Uninstalling printer drivers and printer utilities	34
Plug and play or Add Printer Wizard	34
Setting drivers using Windows	36
Printer configuration through a network.	37
Web page items and functions	38
Access setup	38
Job control.	39
Job control operation.	39
Hold job list	40
Printer account control	41
Using the printer with a Macintosh	42
Installing the utilities	42
Selecting the printer	43

Paper settings	43
Print settings	43
Installing the display fonts	44
Using the PPD Utility	44
Configuration settings	45
Operation procedure common to all printer configuration settings	45
Default settings	46
Custom settings	47
Operation procedure common to all printer configuration settings	47
Setting items	48
Total count	48
List print	48
Key operator programs	49
Using the programs	49
Structure of the setting method for key operator programs	50
Key operator programs	52
Account control	52
Energy save	52
Operator panel settings	53
Device settings	53
Key operator code change	54
Default settings	54
Interface settings	54
Network settings	55
Initialize/store settings	56
Key Operator Code	56
Troubleshooting and maintenance	57
Misfeed removal	57
General misfeed removal procedure	57
Misfeed in the paper feed area	58
Misfeed in paper tray 1	58
Misfeed in multi-purpose drawer	59
Misfeed in the stand/3 x 500 sheet paper drawer	59
Misfeed in the stand/MPD and 2000 sheet paper drawer	59
Misfeed in the transport area, fusing area and exit area	60
Misfeed in the duplex module	61
Misfeed in the bypass tray	61
Troubleshooting	62
Duplex module	65
Part names	65
Specifications	65
Loading paper in the bypass tray	66
Setting the printer driver for duplex module, bypass tray and exit tray	67
Troubleshooting the duplex module	68
Mail-bin stacker	69
Part names	69
Specifications	69
Specifying mail bins to receive printed output	70
Misfeed in the mail-bin stacker	71
Finisher	72
Part names	72
Specifications	72
Finisher functions	73
Using the finisher functions	73
Staple cartridge replacement	74
Checking the stapler unit	75
Misfeed in the finisher	76
Troubleshooting finisher problems	77
Stapling position quick reference guide for duplex output	78

Saddle stitch finisher	79
Part names	79
Specifications	79
Supplies	80
Saddle stitch finisher functions	80
Staple cartridge replacement and staple jam removal	82
Staple jam removal	83
Disposal of hole punch scrap	84
Misfeed in the saddle stitch finisher	85
Stapling position quick reference guide for duplex output	87
Relationship between print image and saddle stitch	88
Printer specifications	89
List of principal printer driver functions	90
List of combination of peripheral devices	91
Notice page printing	92
Print area	93
PCL symbol set	93

WARRANTY

While every effort has been made to make this document as accurate and helpful as possible, Oki makes no warranty of any kind with regard to its content. All information included herein is subject to change without notice. Oki is not responsible for any loss or damages, direct or indirect, arising from or related to the use of this operation manual.

© Copyright Oki 2002.

All rights reserved.

Reproduction, adaptation or translation without prior written permission is prohibited, except as allowed under copyright laws.

TRADEMARK ACKNOWLEDGMENTS

Microsoft Windows, MS-DOS, and Windows NT are trademarks of Microsoft Corporation in the U.S.A. and other countries.

Macintosh, Power Macintosh, Mac OS, LaserWriter, and AppleTalk are registered trademarks of Apple Computer, Inc.

IBM, PC/AT, and PowerPC are trademarks of International Business Machines Corporation.

Pentium is a registered trademark of Intel Corporation.

PCL is a trademark of the Hewlett-Packard Company.

PostScript® is a registered trademark of Adobe Systems Incorporated.

NetWare is a registered trademark of Novell, Inc.

All other trademarks and copyrights are the property of their respective owners.

BEFORE YOU DO ANYTHING PLEASE READ THIS

INSTALLATION REQUIREMENTS

Due to the complexity and requirement for parts alignment, this machine must be installed by a suitably qualified Engineer unless the configuration being installed is the printer unit and the 500-sheet multi-purpose tray (B83MP) only.

Improper installation may damage this product. Please note the following during initial installation and whenever the machine is moved.

1. The machine should be installed near an accessible power outlet for easy connection.

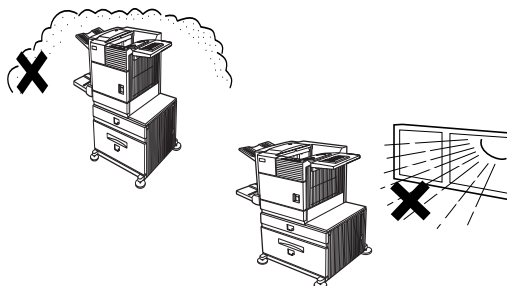

2. Be sure to connect the power cord only to a power outlet that meets the specified voltage and current requirements. Also make certain the outlet is properly grounded.
3. Do not install your machine in areas that are:

- damp, humid, or dusty
- exposed to direct sunlight
- poorly ventilated
- subject to extreme temperature or humidity changes, e.g., near an air conditioner or heater.

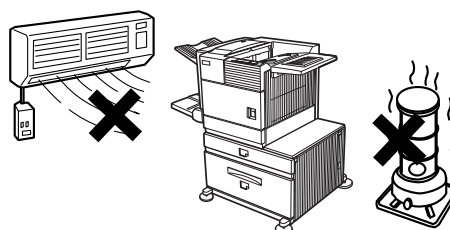

4. Be sure to allow the required space around the machine for servicing and proper ventilation.

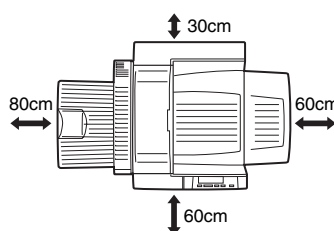

A small amount of ozone is produced within the printer during operation. The emission level is insufficient to cause any health hazard.

The present recommended long term exposure limit for ozone is 0.1 ppm (0.2 mg/m³) calculated as an eight-hour time-weighted average concentration. However, since the small amount that is emitted may have an objectionable odour, it is advisable to place the printer in a ventilated area.

MOVING THE MACHINE

Lift this machine at the positions shown in the illustration below and carry it horizontally.

> CAUTION

Two people are required to lift and carry this machine. The centre of gravity of the machine is slightly to the left of the centre of the machine when viewed from the front. If a duplex module is installed the centre of gravity will be even further shifted to the left. When lifting the machine be careful to steady it to prevent it from toppling. Also be sure that all covers and the duplex module are securely closed and latched before lifting.

If a duplex module is installed, do not lift the machine by the module as it may come off causing it and the machine to drop.

Remove the multi-purpose drawer and lift at the positions shown in the illustration. To avoid injury be sure to completely remove the multi-purpose drawer.

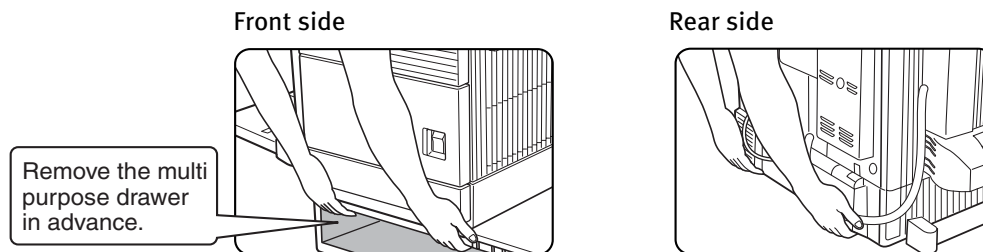

If the machine has been placed on a stand/paper drawer:

The stand/paper drawer is equipped with casters for moving. Unlock the adjusters of the stand/paper drawer and gently move the machine taking care to steady it to prevent it from toppling.

> CAUTION

The centre of gravity of this machine is a little deviated to the left from the centre. If the machine is not equipped with a multi-purpose drawer or a stand/paper drawer, take care in opening the left side cover (or the duplex module) not to cause toppling of the machine.

Do not cover the ventilating holes of this machine. Do not install this machine in a location where these holes are covered. If these holes are covered, heat will not be dissipated and a fire may be caused.

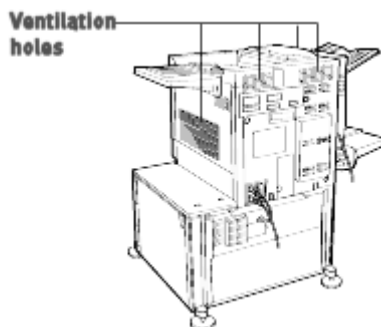

GENERAL WARNINGS

1. Do not touch the photo drum. Scratches or smudges on the drum will cause dirty prints.
2. The fusing unit is extremely hot. Exercise care in this area.
3. Five adjusters are provided on all optional stand/paper drawer units. These adjusters should be lowered until they contact the floor.
4. Do not make any modifications to this machine. Doing so may result in personal injury or damage to the machine.
5. Since this machine is heavy, to prevent injury it is recommended that it be moved by more than one person.
6. When connecting this machine to a computer, be sure to turn both computer and printer off before connecting the devices.
7. Do not print anything which is prohibited from printing by law. The following items are normally prohibited from printing by national law. Other items may be prohibited by local law.

- > Money
- > Stamps
- > Bonds
- > Stock

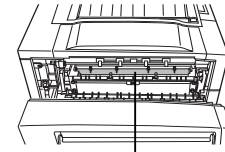

Fusing unit

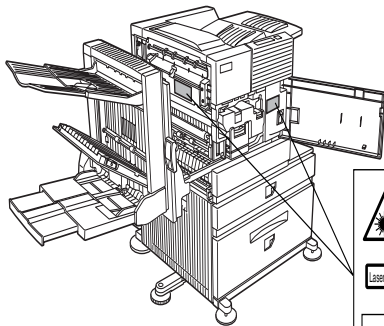

	CAUTION	<small>INVISIBLE LASER RADIATION WHEN OPEN INTERLOCKS DEFEATED. AVOID EXPOSURE TO BEAM.</small>
	VORSICHT	<small>UNSICHTBARE LASERSTRAHLUNG WENN ABDECKUNG GEÖFFNET UND SICHERHEITSPERRUNG ÜBERBRÜCKT. NICHT DEM STRAHL AUSSETZEN.</small>
	ADVARSEL	<small>USYNLIG LASERSTRÅLNING VED ÅBNING, NÅR SIKKERHEDSBRYDERE ER UDE AF FUNKTION. UNDGÅ UDSAETTELSE FOR STRÅLNING.</small>
	VAROITUS!	<small>INVISIBLE LASER RADIATION WHEN OPEN INTERLOCKS DEFEATED. AVOID EXPOSURE TO BEAM.</small>
注意 (サービスマン用) カバーを開けてインターロックを無効にした場合にはレーザー光にさらされないようにしてください。		

<p>CAUTION INVISIBLE LASER RADIATION WHEN OPEN INTERLOCKS DEFEATED. AVOID EXPOSURE TO BEAM.</p> <p>VORSICHT UNSICHTBARE LASERSTRAHLUNG WENN ABDECKUNG GEÖFFNET UND SICHERHEITSPERRUNG ÜBERBRÜCKT. NICHT DEM STRAHL AUSSETZEN.</p> <p>ADVARSEL USYNLIG LASERSTRÅLNING VED ÅBNING, NÅR SIKKERHEDSBRYDERE ER UDE AF FUNKTION. UNDGÅ UDSAETTELSE FOR STRÅLNING.</p>	<p>VAROITUS! LAITTEEN KÄYTTÄMINEN MUULLA KUIN TÄSSÄ KÄYTTÖOHJEESSA MAINITULLA TAVALLA SAATTAA ALTISTAA KÄYTTÄJÄN TURVALLISUUSLUOKAN 1 YLITTÄVÄLLE NÄKYMÄTTÖMÄLLE LASERSÄTEILYLLE.</p> <p>VARNING OM APPARATEN ANVÄNDS PÅ ANNAT SÄTT ÄN I DENNA BRUKSANVISNING SPECIFICERATS, KAN ANVÄNDAREN UTSÄTAS FÖR OSYNLIG LASERSTRÅLNING, SOM ÖVERSKRIDER GRÄNSEN FÖR LASERKLASS 1.</p>
--	---

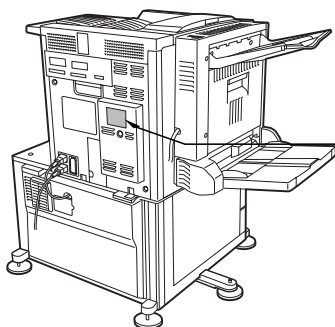

CLASS 1 LASER PRODUCT
LASER KLASSE 1

CLASS 1 LASER PRODUCT
LASER KLASSE 1
LUOKAN 1 LASERLAITE
KLASS 1 LASERAPPARAT

nk
draft
s and
Cheq
ues
> a
sspor
ts
> D
ver's
licens
es

8. Do not throw toner or a toner cartridge into a fire. Toner may spill out or scatter, causing a burn.

FOR NORTH AMERICA SAFETY PRECAUTIONS

This Digital Equipment is rated Class 1 and complies with 21 CFR 1040.10 and 1040.11 of the CDRH standards. This means that the equipment does not produce hazardous laser radiation. For your safety, observe the precautions below.

- > Do not remove the cabinet, operation panel or any other covers.

- › The equipment's exterior covers contain several safety interlock switches.
- › Do not bypass any safety interlock by inserting wedges or other items into switch slots.

Use of controls or adjustments or performance of procedures other than those specified herein may result in hazardous radiation exposure.

FCC Radio Frequency Interference Statement

This equipment has been tested and found to comply with the limits for a Class B digital device, pursuant to Part 15 of the FCC rules. These limits are designed to provide reasonable protection against harmful interference in a residential installation. This equipment generates, uses, and can radiate radio frequency energy and, if not installed and used in accordance with the instructions, may cause harmful interference to radio communication. However, there is no guarantee that interference will not occur in a particular installation. If this equipment does cause harmful interference to radio or television reception, which can be determined by turning the equipment off and on, the user is encouraged to try to correct the interference by one or more of the following measures:

- › Reorient or relocate the receiving antenna.
- › Increase the separation between the equipment and receiver.
- › Connect the equipment into an outlet on a circuit different from that to which the receiver is connected.
- › Consult the dealer or an experienced radio/TV technician for help.

FCC CAUTION: To assure continued compliance,(example- use only shielded interface cables when connecting to computer or peripheral devices). Any changes or modifications not expressly approved by the party responsible for compliance could void the user's authority to operate the equipment.

This device complies with Part 15 of the FCC Rules. Operation is subject to the following two conditions: (1) This device may not cause harmful interference, and (2) this device must accept any interference received, including interference that may cause undesired operation.

LASER CAUTIONS

This product contains a low power laser device. To ensure the user's safety do not remove any cover or attempt to gain access to the inside of the product. Refer all servicing to qualified personnel.

Wave length	785 nm +10 nm /-15nm
Pulse times	Europe 45 cpm model: (4.4 μs ± 4.4 ns)/7 mm USA: 45 cpm model: (5.7 μs ± 5.7 ns)/7 mm
Output power	0.2 mW - 0.4 mW

OVERVIEW

INTRODUCTION

Thank you for buying the Oki B8300 high speed digital printer. Before attempting to use the product, it is recommended that the user studies this manual to familiarise themselves with the main functions of the product and to take notice of the various safety recommendations. A minimum level of computer literacy is necessary for the installation of the printer drivers and Oki recommends that if the user is uncertain how to proceed they should refer this item to their system administrator.

ORIGINAL AND PAPER SIZES

The Oki B8300 uses media of standard sizes in both metric and imperial systems. The standard sizes available are shown below.

IMPERIAL	SIZES	AB SYSTEM	SIZES
TABLOID	11 x 17	A3	297 x 420
LEGAL	8½ x 14	B4	250 x 353
FOOLSCAP	8½ x 13	A4	210 x 297
LETTER	8½ x 11	B5	176 x 250
EXECUTIVE	7¼ x 10½	A5	148 x 210
INVOICE	5½ x 8½		

The meaning of “R” in original and paper size indications

Some original and paper sizes can be placed in either portrait or landscape orientations.

To differentiate between the two sizes in the various tables further on in the book, the landscape orientation size indication will contain an “R”. These are indicated as 8½ x 11R, 5½ x 8½R, A4R, B5R, etc. Sizes that can be placed only in the landscape orientation (11 x 17, 8½ x 14, 8½ x 13, A3, B4) do not contain the “R” in their size indication.



Landscape orientation Portrait orientation

MAIN FEATURES

A wide range of accessories to enhance your productivity

Options, such as duplex units for producing two-sided output, additional paper feed units to increase the variety of available paper sizes and paper capacity, paper output units to sort and otherwise organize output.

600 dpi high resolution printing

High-definition and high quality printing with 600 dpi resolution can be performed. Also high image quality, equivalent to 1200 dpi, can be obtained by using the smoothing function.

High speed monochrome printing

The printer achieves high speed printing at 45 A4 (or letter) size pages per minute.

PostScript compatible

PostScript 3 is standard.

ENERGY SAVING FEATURES

Preheat mode

The preheat mode is the first level of power reduction. The power is reduced to the fuser unit a preset time after the machine has completed a job and no further machine operations have been made. The machine can recover to the ready condition within a short period of time. The preset time to enter the mode can be set by a key operator program.

Auto power shut-off mode

The auto power shut-off mode is the second level of power reduction. In this mode power is shut off to the fusing unit and the touch panel. In this state more energy is saved than in the preheat mode but the time to recover to the ready condition will be longer. The preset time to enter this mode can be set by a key operator program.

When in use, and either of the above modes is active, the mode will be deactivated automatically by an incoming job and the machine will automatically warm up and start to print when it has reached the ready temperature.

PART NAMES AND FUNCTIONS

EXTERIOR

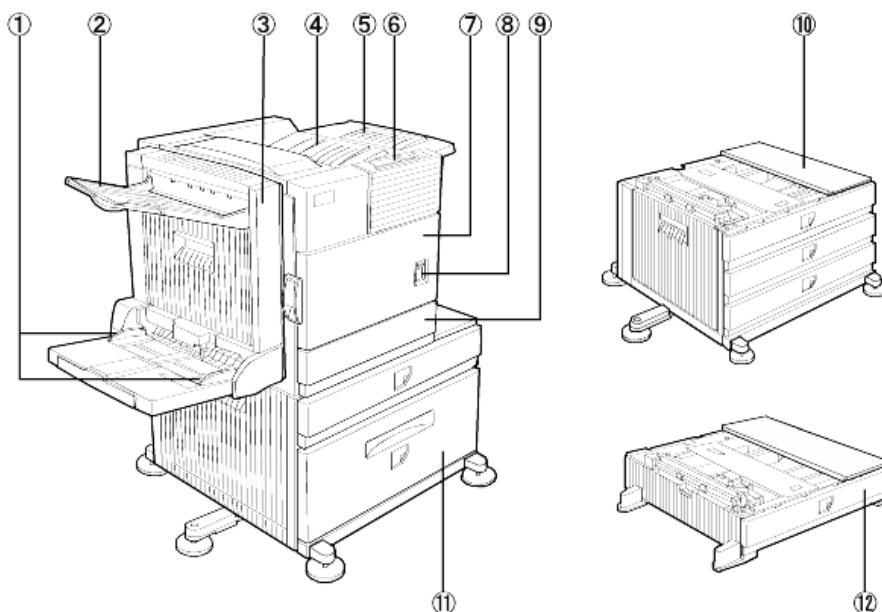

- 1. Bypass tray paper guide
- 2. Exit tray
- 3. Duplex module/bypass tray
Module for two-sided printing.
- 4. Upper paper output area
Finished sheets are deposited here.
- 5. Upper exit tray extension
Provides support for large size paper.
- 6. Operation panel
- 7. Front cover
Open to add toner.
- 8. Main switch

- 9. Paper tray 1
- 10. Stand/3 x 500 sheet paper drawer*
- 11. Stand/MPD and 2000 sheet paper drawer
- 12. Multi-purpose drawer*

Notes:
Items 2, 3, 10, 11 and 12 are peripheral devices.
One of devices 10, 11 or 12 must be installed.
If you install device 3, 10 or 11 a power supply unit must also be installed.

INTERIOR

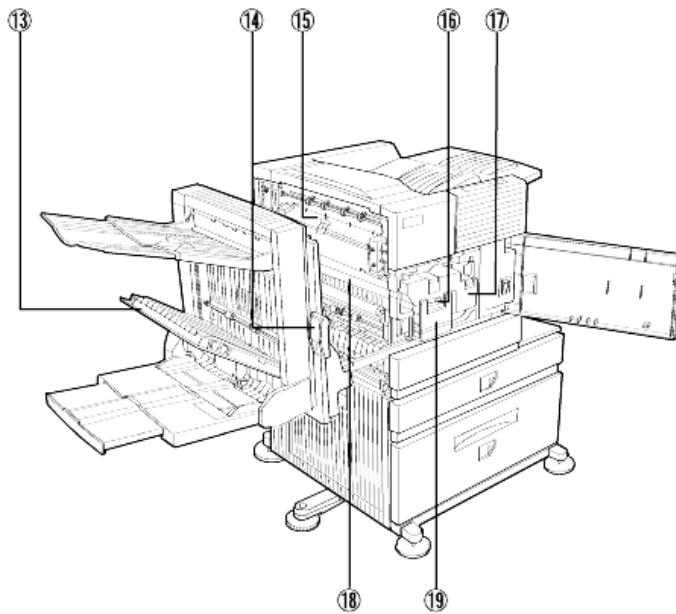

13. Duplex module side cover

Open when a misfeed has occurred in the duplex module.

14. Side cover latch

Push up to open the side cover when a misfeed has occurred in the main unit.

15. Fusing unit

Lift up to open the side cover when a misfeed has occurred in the main unit.

16. Developer cartridge

This cartridge contains developer and must be removed and replaced by a new cartridge when indicated on the operation panel.

17. Toner cartridge (drum/toner cartridge)

The toner cartridge must be replaced when indicated on the operation panel.

18. Photoconductive drum

Images are formed on the photo drum.

19. Cartridge lock lever

When replacing the drum, toner or developer cartridge, move this lever down and pull it out.

For replacement and installation of cartridges, refer to the relevant documentation.

Your attention is drawn to the following cautions

Take care when handling toner. Avoid getting toner on your skin, in your eyes or on your clothes. Should you get toner on you wash the affected part with copious amounts of COLD water. If ingested or you get toner in the eyes, seek medical advice. If your clothes are splattered, brush off as much of the toner as possible and rinse with cold water.

The fusing unit is hot. Take care when removing misfed paper.

Do not touch or damage the photo drum.

PART NAMES AND FUNCTIONS

PERIPHERAL DEVICES

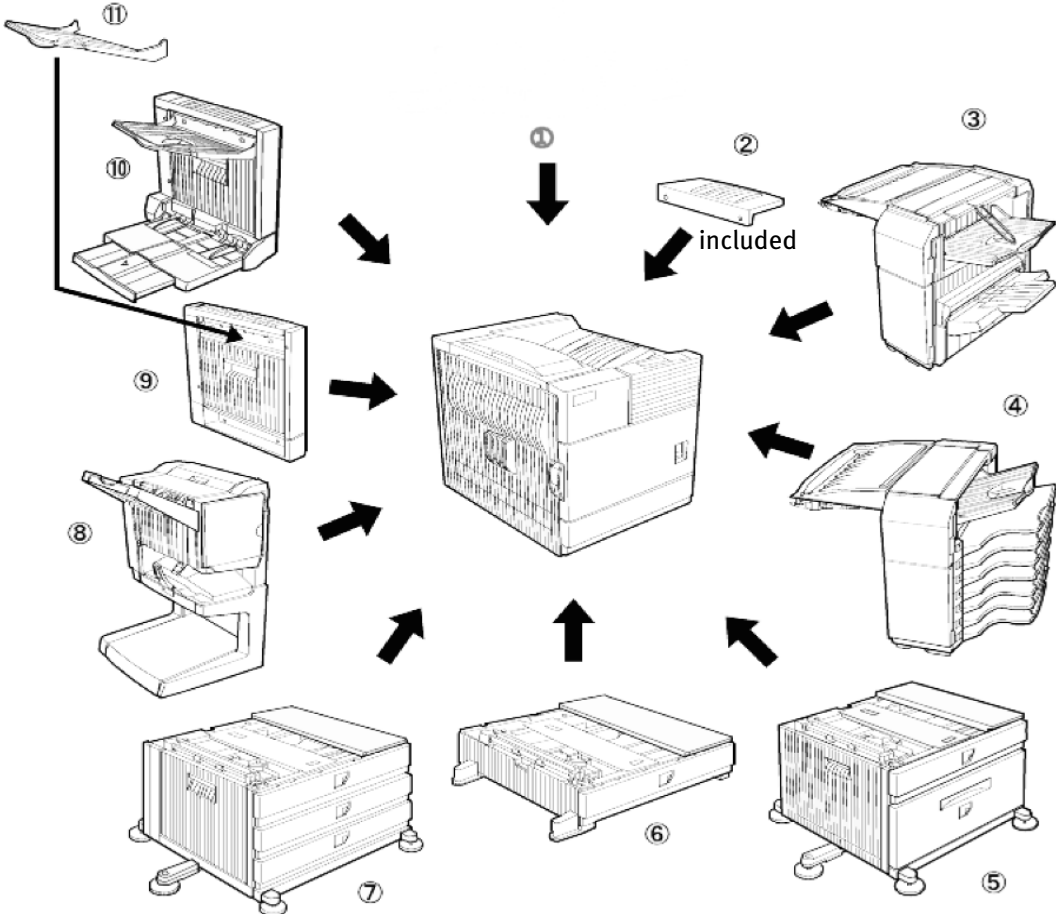

- | | |
|--|--|
| 1. Printer | can hold a maximum of 2000 sheets of 80 g/m ² (20 lb) paper. |
| 2. Upper exit tray extension
Mount this unit to the upper paper exit tray. This extension is needed to support large size paper. | 6. Multi-purpose drawer (B83MP)
Up to 500 sheets of 80 g/m ² (20 lb) paper can be loaded. Special papers such as envelopes (standard sizes only) and postcards can also be set. |
| 3. Finisher (B83F)
Output sheets can either be sorted in page order or grouped by page. Sorted sets or groups are offset stacked for easy separation when removed. Sorted sets can be delivered either stapled or unstapled. | 7. Stand/3 x 500 sheet paper drawer (B83TT)
This paper feed unit contains an upper multi-purpose drawer (see item 6) and two lower drawers each of which can hold a maximum of 500 sheets of 80 g/m ² (20 lb) paper. |
| 4. Mail-bin stacker (B83MB)
This unit is an output sorter that has seven receiving bins. The bin to receive printed output can be selected in the printer driver. Each bin can be assigned to receive printed output by an individual person or by groups of people so that their prints are separated from other users making them easy to retrieve.
When this unit is installed, any copies will be sent to the top tray and not to the mail bins. | 8. Saddle stitch finisher (B83SS)
The saddle stitch finisher can automatically place two staples for centreline binding of prints or copies and fold them along the centreline. An optional hole punching unit is available for installation into the finisher. |
| 5. Stand/MPD and 2000 sheet paper drawer (B83LT)
This paper feed unit contains an upper multi-purpose drawer (see item 6) and a lower drawer which | 9. Duplex module (B83D)
An optional duplex module must be installed for automatic two-sided printing. |
| | 10. Duplex module/bypass tray (B83DB)
This module is basically the same as above with the addition of a manual bypass paper feed unit. |
| | 11. Mounted to the paper output port of a duplex module. |

Some peripheral devices cannot be installed together while others may require the installation of one or more others to be functional.

See Chapter 6, *List Of Combination Of Peripheral Devices*.

Other optional equipment (not shown)

120 or 240V power supply unit (B83PS).

The voltage will depend upon the region in which the product is used.

Some peripheral devices require the installation of this power supply.

Hard disk drive (B83HD).

Extends the printer's image storing capacity.

This unit is required for the job retention function to operate.

2-hole punch (B83THP).

2-3 hole punch (B83USP).

4-hole punch (B83FHP).

4-hole broad-space punch (B83FBP).

OPERATION PANEL OF THE MAIN UNIT

The display and indicators show the current status of the printer. All printer settings are made by using the keys and display panel.

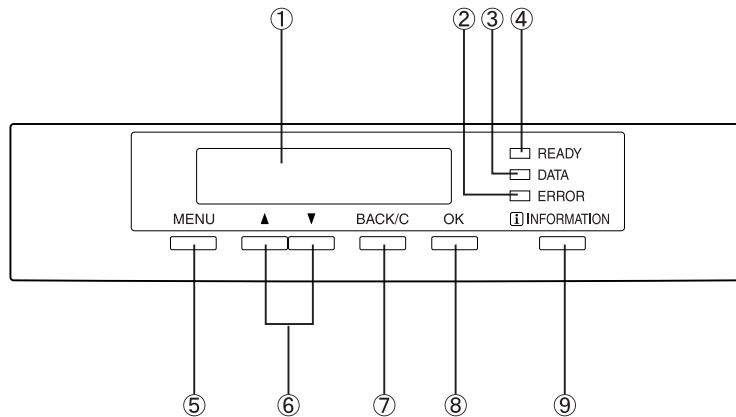

1. Message display

Displays the current status of the printer. [i] displayed in any message indicates that the [INFORMATION] key should be pressed.

2. [ERROR] indicator

Lights up when paper or toner must be added or when a misfeed has occurred in the machine. Blinks when an abnormal condition has occurred in the machine.

3. [DATA] indicator

Lights up or blinks when print data is being received or output. Also lights up when job data is stored by the job retention function.

4. [READY] indicator

Print data can be received when this indicator is lit.

5. [MENU] key

Press to select a menu group such as printer configuration menu, custom settings or execution of print jobs held by the retention function. Also, press to return to the job status screen from the setting screen of each job status group.

6. [▲/▼] keys

Press to select menu or function items or to set numerical values for those items.

7. [BACK/C] key

Use this key to return to the previous screen in each menu selection, to cancel and delete the current job or to delete a reserved job that has been selected.

8. [OK] key

Press to register the selected menu or function.

9. [INFORMATION] key

When [i] is displayed with a message indicating a paper misfeed, the relevant operation procedure can be displayed by pressing the [INFORMATION] key. If the [INFORMATION] key or the [BACK/C] key is pressed while the operation procedure is displayed, the information mode will be cancelled. If this key is pressed and held down while printing is being performed or in standby mode, the total number of printed pages and quantity of toner remaining (as a percentage) will be displayed.

MENU GROUP AND KEY EXPLANATIONS

MAIN UNIT OPERATION PANEL

The menu groups are classified into five groups and are selected consecutively by pressing the [MENU] key. If the [OK] key is pressed when the desired menu screen is displayed, a message will appear to indicate the next required operation.

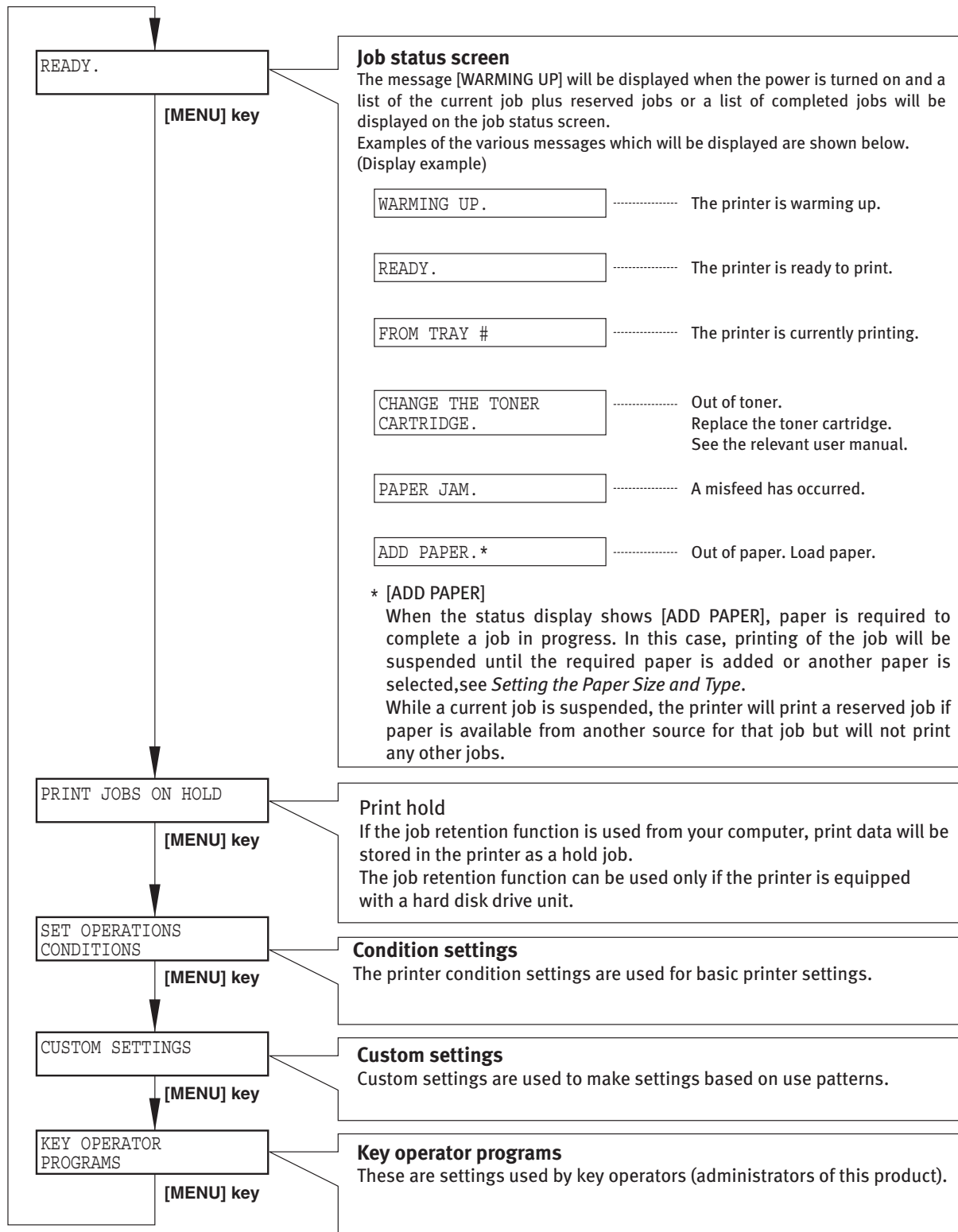

CANCELLING A PRINT JOB AND DELETING PRINT DATA

1. Press the [BACK/C] key during printing.

Printing will stop and a message asking for confirmation to delete the job will appear.

2. Press the [OK] key to delete the data.

To cancel deletion, press the [BACK/C] key.

Printing will resume.

TO DELETE PRINT DATA OF A RESERVED JOB (JOBS STORED IN THE PRINTER)

Print data transmitted from computers will be stored in this printer (up to 99 jobs) and will be printed sequentially.

To delete print data of a reserved job before starting printing:

1. Press the ▲ or ▼ key to display the desired data in the message display.

If you press the [BACK/C] key at this time, a confirmation message for deletion will appear.

2. Press the [OK] key to delete the data.

To cancel deletion, press the [BACK/C] key to cancel deletion,.

Printing will resume.

LOADING PAPER

- › The message “ADD PAPER” or “OPEN TRAY AND ADD PAPER” will appear when paper runs out during operation. Follow the procedure below to load paper.
- › Do not use curled or folded paper. Doing so may cause a misfeed.
- › For best results use a good quality paper designed for use in page printers.
- › When you change the paper type and size in paper tray 1, set the paper type and size referring to *Setting the Paper Size and Type*.
- › Do not place heavy objects into, or press down hard upon, any tray which is pulled out.

LOADING PAPER IN PAPER TRAY 1

1. Gently pull out tray 1 until it stops.

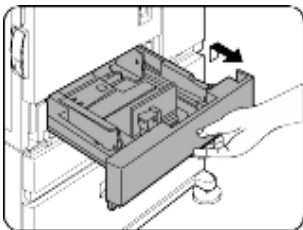

2. Load paper into the tray.

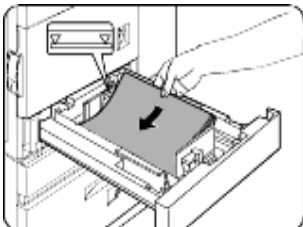

Do not load paper above the maximum height line (approximately 500 sheets of 80 g/m² (20 lb) paper).

3. Gently push tray 1 firmly all the way into the machine.
4. Set the paper type. If you change the paper type, be sure to set the correct type by referring to *Setting the Paper Size and Type* section.

Loading paper in paper tray 1 is now complete.

CHANGING THE PAPER SIZE IN PAPER TRAY 1

For paper tray 1, 8½" x 11", A4 or B5 size paper can be set. Use the following procedure to change the size as needed.

1. Pull out paper tray 1. If paper remains in the tray, remove it.
2. Adjust the guide plates A and B in the tray to the length and width of the paper.

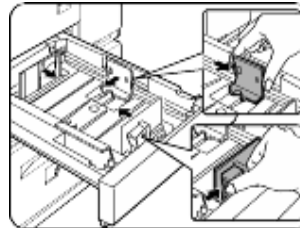

The guide plates A and B can slide. Adjust them to the paper size to be loaded while squeezing their lock levers.

3. Load paper into the tray.
4. Gently push tray 1 firmly all the way into the machine.
5. Set the paper size.

Be sure to set the paper size and paper type referring to *Setting the Paper Size and Type*. If this is not done, paper misfeeds will occur.

Changing paper size in paper tray 1 is now complete.

SPECIFICATIONS OF PAPER TRAYS

The specifications for types and sizes of paper for loading paper trays are shown below.

TRAY	TRAY NO. (TRAY NAME)	APPLICABLE PAPER TYPES	APPLICABLE PAPER SIZES	PAPER WEIGHT
Paper tray 1	Tray 1	Plain paper. (Refer to the next page for applicable plain papers.)	<ul style="list-style-type: none"> 8½ x 11, A4, B5 	60 to 105 g/m ² or 16 to 28 lb
Multi-purpose drawer/bypass tray	Tray 2/bypass tray	Plain paper. (Refer to the next page for applicable plain papers.)	<ul style="list-style-type: none"> If [AUTO-INCH] is selected in setting the paper size and type, the following paper sizes can be used with the automatic detection function: 11 x 17, 8½ x 14, 8½ x 11, 8½ x 11R, 7¼ x 10½R, 5½ x 8½R If [AUTO-AB] is selected in setting the paper size and type, the following paper sizes can be used with the automatic detection function: A3, B4, A4, A4R, B5, B5R, A5R, 8½ x 13 Non-standard sizes 	60 to 128 g/m ² or 6 to 34 lb
		Special paper. (Refer to the next page for applicable special papers.)	<ul style="list-style-type: none"> Thick paper Labels Transparency film 	See the remarks for special paper on the next page
		Envelopes can only be fed from the multi-purpose drawer. Applicable paper stock weight for envelopes is 75 to 90 g/m ² or 20 to 23 lb	<ul style="list-style-type: none"> If [AUTO-INCH] is selected in setting the paper size and type, the following paper sizes can be used with the automatic detection function: 11 x 17, 8½ x 14, 8½ x 11, 8½ x 11R, 7¼ x 10½R, 5½ x 8½R If [AUTO-AB] is selected in setting the paper size and type, the following paper sizes can be used with the automatic detection function: A4, A4R, B5, B5R Non-standard sizes smaller than A4 or 8½ x 11 	
Stand/3 x 500 sheet paper drawer	Upper	Tray 2	Same as multi-purpose drawer	
	Middle	Tray 3	Plain paper. (Refer to the next page for applicable plain papers.) <ul style="list-style-type: none"> If [AUTO-INCH] is selected in setting the paper size and type, the following paper sizes can be used with the automatic detection function: 11 x 17, 8½ x 14, 8½ x 11, 8½ x 11R, 7¼ x 10½R, 5½ x 8½R If [AUTO-AB] is selected in setting the paper size and type, the following paper sizes can be used with the automatic detection function: A3, B4, A4, A4R, B5, B5R, A5R, 8½ x 13 	60 to 105 g/m ² or 16 to 28 lb
Stand/MPD and 2000 sheet paper drawer	Lower	Tray 4		
	Upper	Tray 2	Same as multi purpose drawer	
	Lower	Tray 3	Plain paper. (Refer to the next page for applicable plain papers.) <ul style="list-style-type: none"> A4, 8½ x 11 	60 to 105 g/m ² or 16 to 28 lb

APPLICABLE PLAIN PAPER

For satisfactory results, plain paper must conform to the following requirements.

	Paper in AB system	Paper in inch system
		A5 to A3
Plain paper	60 to 105 g/m ² or 16 to 28 lb	
Recycled, coloured, pre-punched, pre-printed and letterhead papers must conform to the same conditions as above.		

APPLICABLE SPECIAL PAPER

For satisfactory results, special paper must conform to the following requirements.

	TYPE	REMARKS
Special paper	Thick paper	<ul style="list-style-type: none"> ● For A5 to A4, 5½ x 8½ and 8½ x 11 sizes, thick paper ranging from 60 to 128 g/m² or 16 to 34 lb or can be used ● For sizes larger than A4 or 8½ x 11, thick paper ranging from 60 to 105g/m² or 16 to 28 lb can be used ● Other thick papers ● Index stock (176 g/m² or 65 lb) can be used ● Cover stock (200 to 205 g/m² or 110 lb) can be used but only for A4, 8½ x 11, paper in portrait orientation ● For A5 or 5½ x 8½ paper, orientation must be landscape
	Transparency film, labels	<ul style="list-style-type: none"> ● Use media from established suppliers (Avery, 3M, etc.) which are described as being suitable for digital printers ● Failing to do so may leave adhesive residue in the printer, causing paper misfeeds, smudges on prints or other problems
	Envelopes	<ul style="list-style-type: none"> ● Applicable standard envelopes: COM-10, Monarch, DL, C5, ISO B5 ● Envelopes can only be fed from the multi-purpose drawer ● Applicable paper stock weight for envelopes is 75 to 90g/m² or 20 to 23 lb

SETTING THE PAPER SIZE AND TYPE FROM THE OPERATION PANEL ON THE MAIN PRINTER

When the paper size or type is changed in a paper tray, set them up by referring to the following procedure.

1. Press the [MENU] key repeatedly until **CUSTOM SETTINGS** appears in the message display.

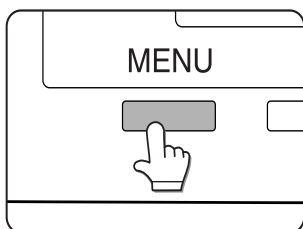

2. Press the [OK] key.

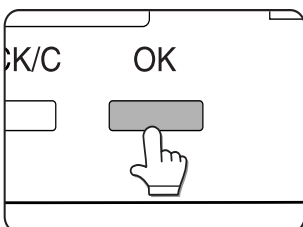

3. When the [OK] key is pressed, **TRAY SETTING** will appear in the message display.



When the [OK] key is pressed, the message shown above will appear in the message display.

4. Select the desired paper tray.

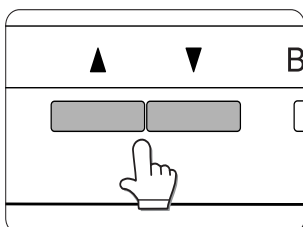

Press the ▲ or ▼ key repeatedly until the desired paper tray is indicated in the display.

5. Press the [OK] key.

The paper size and paper type of the tray selected in step 4 will appear.

If TRAY 1 is selected in step 4, the message shown below will appear in the display.



6. Press the ▼ key

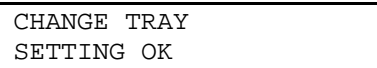

If TRAY 1 is selected in step 4, the message shown above will appear in the display.

7. Press the [OK] key. To cancel the setting change, press the [BACK/C] key to return to step 4.
8. Select the paper type that has been set in the tray. Press the ▲ or ▼ key repeatedly until the paper type that has been set appears.

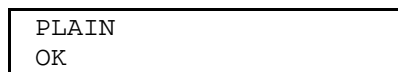

- > Special paper such as thick paper, transparency film, labels, and postcards can be set for tray 2 and the bypass tray.
 - > Envelopes can be set only for tray 2.
9. Press the [OK] key.
 10. Ensure that the desired paper size is selected. Press the ▲ or ▼ key repeatedly until the desired paper size appears.

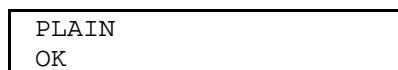

- > Depending on the selected tray, a selection for **AUTO-AB** and **AUTO-INCH** may appear. **AUTO-AB**: Select when you have set AB system paper.
 - > **AUTO-INCH**: Select when you have set inch system paper.
 - > When the paper system is changed from the inch system to the AB system or vice versa, the paper type must be designated. Select the paper type.
 - > If you have set paper of non-standard size, select **NON STANDARD**. This size can be selected when tray 2 or the bypass tray has been selected in step 4.
11. Press the [OK] key to complete the setting.

LOADING PAPER IN THE MULTI-PURPOSE DRAWER

The method of loading paper into the multi-purpose drawer is the same as for paper tray 1 as previously described. When loading envelopes, postcards or transparency film, follow the descriptions below.

- › Two maximum height lines are indicated: one for plain paper and one for special paper.

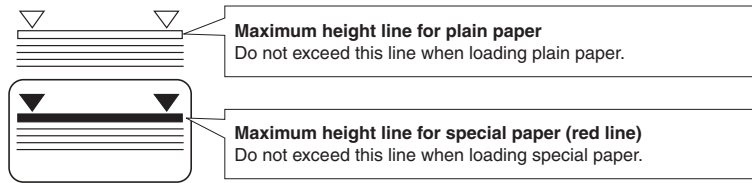

Setting envelopes or postcards

When setting envelopes or postcards in the multi-purpose drawer, set them as shown below.

Loading postcards

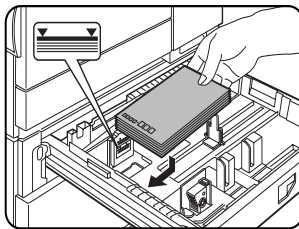

Load postcards print side up to the rear left of the tray as shown.

Loading envelopes

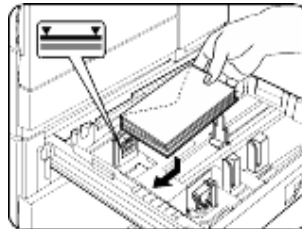

Envelopes can only be printed on the address side. Be sure to place envelopes with the address side up and the top of the envelope to the rear.

Printing on to envelopes or postcards

- › Attempting to print on to both sides of envelopes or postcards may result in misfeeds or poor prints.
- › Do not use pre-printed envelopes.
- › To avoid wrinkling, misfeeds or poor printing, make sure the postcard stock is not curled.

Printing on to envelopes

- › Do not use envelopes that have metal clasps, plastic snaps, string closures, windows, linings, self-adhesive patches or synthetic materials. Attempting to print on these may cause misfeeds, inadequate toner adherence or other problems.
- › Embossed envelopes whose surface is not flat may cause the smudged prints.
- › Under high humidity and temperature conditions the glue flaps on some envelopes may become sticky and be sealed closed when printed.
- › Use only envelopes which are flat and crisply folded. Curled or poorly formed envelopes may be poorly printed or may cause misfeeds.

FUSING UNIT PRESSURE ADJUSTING LEVERS

When feeding envelopes from the multi-purpose drawer, damage to the envelopes or smudges on prints may occur even if envelopes within specification are used. In this case, the problem may be reduced by shifting the fusing unit pressure adjusting levers from the normal position to the lower pressure position. Follow the procedure below.

Be sure to return the lever to the normal position when finished feeding envelopes. If not, inadequate toner adherence, paper misfeeds or other problems may occur.

1. Unlatch the duplex module and slide it to the left. If the machine is not equipped with a duplex module, open the side cover to gain access.

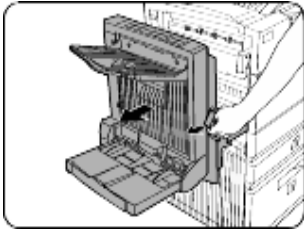

2. Lower the two fusing unit pressure adjusting levers marked A and B in the illustration.

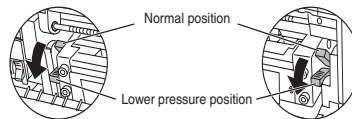
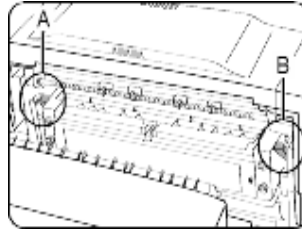

A: Rear side of fusing unit

B: Front side of fusing unit

3. Gently close the duplex module. If the machine is not equipped with a duplex module, close the side cover.

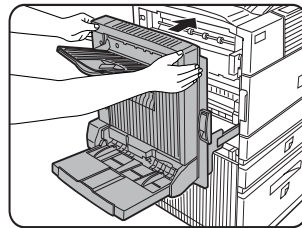

LOADING TRANSPARENCY FILM

Be sure to load the transparency film with the white label side up.

Make sure no image will be printed on the label.

Printing on the label may cause smudges on prints.

Transparency film must be placed in portrait orientation.

Specifications (multi-purpose drawer)

Name	Multi-purpose drawer
Paper size/weight	See specifications of paper trays
Paper capacity	500 sheets 80g/m ² (20 lb) of paper, 40 envelopes, 20 postcards
Dimensions	654 mm (W) x 567 mm (D) x 144 mm (H) 25 ³ / ₄ " (W) x 22 ²¹ / ₆₄ " (D) x 5 ⁴³ / ₆₄ " (H)
Weight	Approx. 11 kg (24.3 lb)
	Specifications are subject to change without notice.

LOADING PAPER IN THE STAND/3 X 500 SHEET PAPER DRAWER

● Upper paper tray

The upper tray is the same as the multi-purpose drawer. Use the upper tray according to the instructions for the multi-purpose drawer.

● Middle and lower paper trays

Up to 500 sheets of recommended plain paper can be loaded into these trays. The method of loading paper is the same as for paper tray 1 in the main unit.

If the paper size or paper type is changed in either paper tray, the tray settings must be changed in custom settings. Refer to *Setting the Paper Size and Type*.

Specifications (stand/3 x 500 sheet paper drawer)

Name	Stand 3/500 sheet paper drawer
Paper size/weight	See specifications of paper trays
Paper capacity (ordinary paper)	500 sheets 80g/m ² (20 lb) each
Dimensions	619 mm (W) x 664 mm (D) x 404 mm (H) 24 ³ / ₈ " (W) x 26 ⁵ / ₃₂ " (D) x 15 ²⁹ / ₃₂ " (H)
Weight	Approx. 32 kg (70.6 lb)
	Specifications are subject to change without notice.

LOADING PAPER IN THE STAND/MPD AND 2000 SHEET PAPER DRAWER

● Upper paper tray

The upper paper tray is equivalent to the multi-purpose drawer. The method of loading paper and the paper that can be used are the same as for the multi-purpose drawer. Refer to the description of the multi-purpose drawer.

● Lower paper tray

The lower paper tray is a large capacity tray that holds 2,000 sheets of A4 or 8½" x 11" paper (80 g/m² or 20 lb). Use the following procedure to load paper into the large capacity tray.

If the paper size or paper type is changed in either paper tray, the tray settings must be changed in custom settings. Refer to *Setting the Paper Size and Type*.

1. Pull out the large capacity tray until it stops.

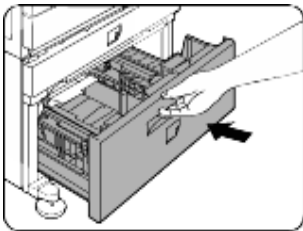

2. Load paper into the right-hand paper feed tables. This holds approximately 1,200 sheets.

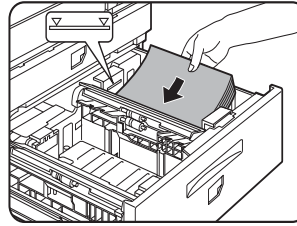

3. Raise the paper guide and load paper into the left-hand paper feed table. This holds approximately 800 sheets. After loading paper, be sure to return the paper guide.
4. Gently push the large capacity paper tray firmly all the way into the printer.

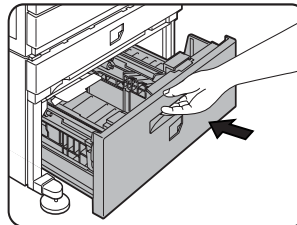

5. Set the paper type.

If you have changed the paper size from the AB system to the inch system or vice versa, select the relevant type referring to *Setting the Paper Size and Type*.

Loading paper in the stand/MPD and 2000 sheet paper drawer is now complete.

Specifications (stand/MPD and 2000 sheet paper drawer)

Name	Stand/MPD and 2000 sheet paper drawer
Paper size/weight	See specifications of paper trays
Paper capacity (ordinary paper)	Upper tray: 500 sheets 80g/m ² (20 lb) Lower tray: 2,000 sheets 80g/m ² (20 lb)
Dimensions	619 mm (W) x 664 mm (D) x 404 mm (H) 24 ³ / ₈ " (W) x 26 ⁵ / ₃₂ " (D) x 15 ²⁹ / ₃₂ " (H)
Weight	Approx. 34 kg (75 lb)
	Specifications are subject to change without notice.

STORAGE OF SUPPLIES

Oki recommends the use of Oki original consumables. Counterfeit products may damage your printer's performance and invalidate your warranty.

Standard supplies for this product that are to be replaced by the user include:

Paper, print cartridge, developer cartridge, and staple cartridge for the finisher.

- **Proper storage**

Store the supplies in a location that is

- › Clean and dry.
- › At a stable temperature.
- › Not exposed to direct sunlight.

- **Store paper in the wrapper and lying flat.**

- › Paper incorrectly stored, or out of the wrapper, may curl or become damp, resulting in misfeeds.

SUPPLY LIST

PRODUCT	EUROPEAN PART NO.	NORTH AMERICAN PART NO.
27k Printer cartridge	TONER-B8300	56115001
100k Developer cartridge	DVLPR-B8300	57100101
Staple Pack for Finisher	STAPLE-B8300-FNR	57100201
Staple Pack for Saddle Stitcher	STAPLE-B8300-SSF	57100801

- › If a cartridge is to be discarded, dispose of it according to local requirements.
- › Store printer and developer cartridges out of the reach of children.

ADDING TONER

When toner runs out, the message **CHANGE THE TONER CARTRIDGE** will appear on the display indicating that the print cartridge must be replaced. If you press and hold down the [INFORMATION] key while printing is being performed or in standby, the quantity of toner remaining (as a percentage) will be displayed. When the percentage appears within the range of 0-25 per cent prepare a new printer cartridge.

The machine as shipped does not have a cartridge installed. Follow the steps below for instructions for installing the first cartridge omitting step 4.

- The print cartridge contains toner and a photoconductive drum. The photoconductor on the drum can deteriorate by exposure to light for an extended period of time.
- Do not remove the cartridge from its protective package until it is ready to be installed into the machine.

1. Turn off the power and open the front cover.

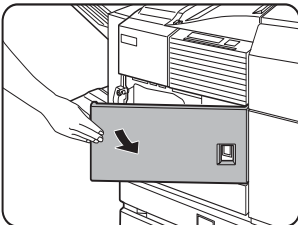

2. Lower the cartridge lock lever.

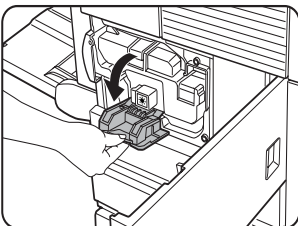

3. Pull out the duplex module. Unlatch the unit and gently move the module away from the machine. If the machine is not equipped with the duplex module, open the side cover to access.

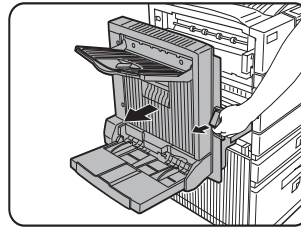

4. While depressing the lock release button, pull out the printer cartridge and remove it.

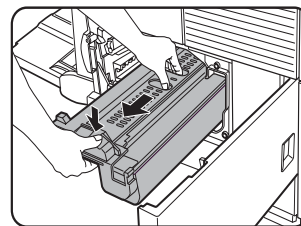

5. Remove the new printer cartridge from its bag and remove the protective material A.

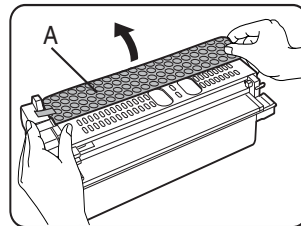

6. Shake the new cartridge horizontally five or six times.

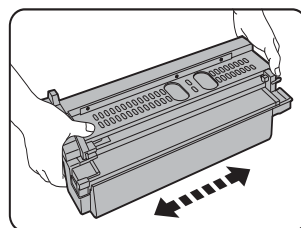

7. Insert the new printer cartridge. Push the cartridge in until it locks securely into place.

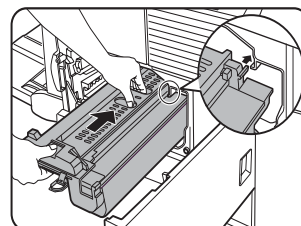

8. Gently remove the sealing tape from the cartridge.

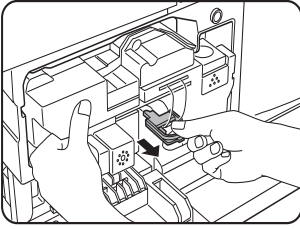

9. Remove the drum protective sheet from the printer cartridge.

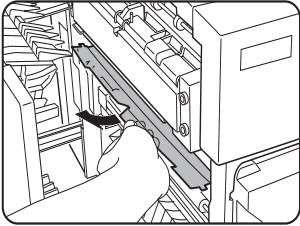

- › **Do not touch or damage the surface of the photo drum.**

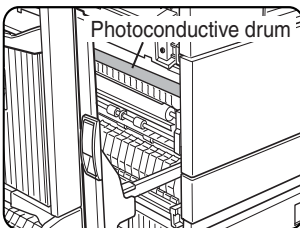

10. Close the duplex module. If the machine is not equipped with the duplex module, close the side cover.

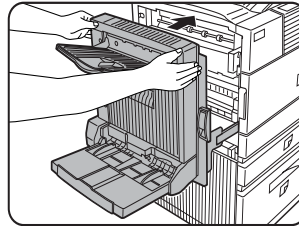

11. Return the cartridge lock lever and close the front cover.

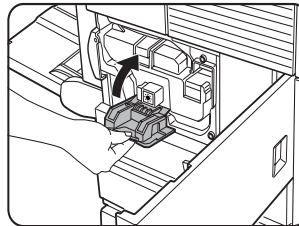

- Do not shake the developer cartridge after the sealing tape has been removed. If the cartridge is shaken after the tape is removed, some developer will come out of the cartridge.

DEVELOPER CARTRIDGE REPLACEMENT

When the cartridge needs replacing, a message indicating the need to replace it will appear in the display. Follow the procedure below to replace the developer cartridge. The machine as shipped from the factory does not have a cartridge installed.

Follow the procedure below to install the first cartridge omitting steps 3 and 4.

1. Turn off the power and open the front cover.

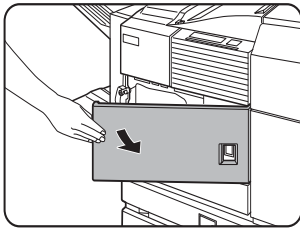

2. Lower the cartridge lock lever.

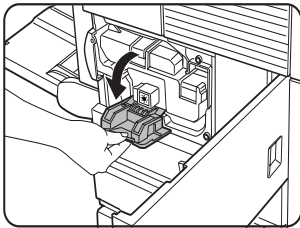

3. Remove the developer cartridge. Push the lock release button and pull out the developer cartridge until it stops.

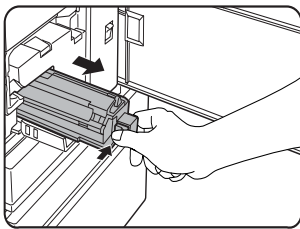

4. Push the lock button at the rear and remove the developer cartridge.

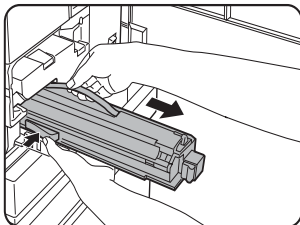

5. Remove the new developer cartridge from its bag and remove the tape and protective material A and B.

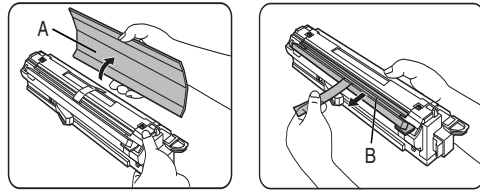

6. Shake the new developer cartridge horizontally five or six times.

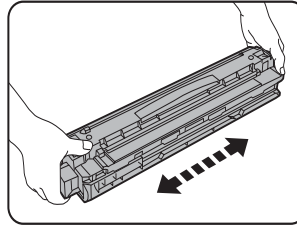

7. Insert the new developer cartridge.

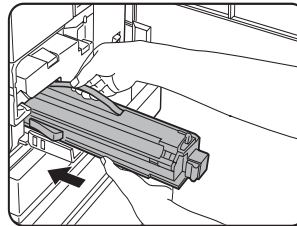

8. Push the cartridge in until it locks securely into place.

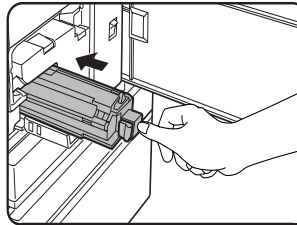

9. Close the front cover. The machine will become available in about two minutes.

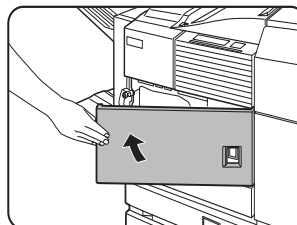

- Do not shake the developer cartridge after the sealing tape has been removed. If the cartridge is shaken after the tape is removed, some developer will come out of the cartridge.

PRINTING FROM A COMPUTER

This chapter describes how to install and how to use the printer drivers and printer utilities on a computer. This chapter also describes the job retention function that allows a print start operation from the operator panel of the printer.

CONNECTING THIS MACHINE AS A LOCAL PRINTER

When using this machine as a local printer, connect your computer to the parallel interface connector as shown in the illustration. The cable is not supplied with the printer. A shielded cable which conforms to both the printer specifications and your computer specifications must be obtained. Consult your computer manual for the computer connection requirements.

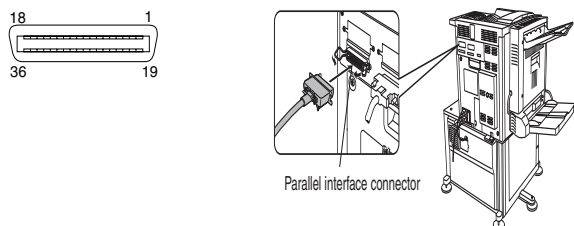

The parallel interface of the printer conforms to IEEE-STD-1284-1993. The connector type on the printer is a 36-pin DDK 57LE-40360-730B (D29) female connector or equivalent. For the specifications of the parallel interface connector on the computer, see your computer manual.

SOFTWARE FOR WINDOWS

When using this product in a Windows environment, you must install a printer driver in your computer system. Use the CD-ROM supplied with this unit for the installation of the driver. This product can be connected through a parallel interface connector as described above, or connected as a network printer through a Network Interface Card (NIC)..

The following software for Windows is contained in the CD-ROM.

- > Printer drivers
- > Printer utilities
- > Installer. This is software used for installing printer drivers and printer utilities.
If you use Plug and Play or the Add Printer Wizard to install the driver without using this program, see appropriate instructions.

PRINTER DRIVERS	PRINTER UTILITIES
PCL printer drivers (PCL5e and PCL6)	Printer Administration Utility
PostScript printer driver (PostScript 3) and PPD files (PostScript Printer Description files)	PrintSuperVision

Printer drivers Printer driver software converts print data from any application into data understood by the printer.

Printer utilities Printer Administration Utility provides setting and monitoring of printers on a computer and is used by system administrators. See the Help file as necessary.

INSTALLING PRINTER DRIVERS AND UTILITIES

The following software can be installed from the installer supplied on the CD-ROM:

- PCL printer drivers (PCL5e and PCL6)
- Printer Administration Utility.

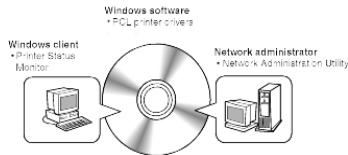

Execute installation from the CD-ROM using the following procedure.

1. Start Windows.
 2. Insert the supplied CD-ROM into a CD-ROM drive of your computer. If your computer is configured for auto start on CD-ROM insertion, the [Language Select] or [User Select] screen described in step 5 will appear. (Steps 3 and 4 are not needed.)
 3. On the [Start] menu, click [Run].
 4. Enter the CD-ROM drive and setup command. Then click [OK]. Example: If the CD-ROM drive is designated as *Drive R:*, enter [R:\SETUP.EXE].
 5. Select the language which you want to use.
 6. Select [Online Manuals, Driver Installation or Network Utilities] and choose the item you want to install.
- > A restart of your computer may be needed depending on the system. Click [Yes] to restart the computer.

UNINSTALLING PRINTER DRIVERS AND PRINTER UTILITIES

When uninstalling a printer driver that has been installed from the [Add Printer] wizard, right-click the printer to be deleted from [Printers] in the Control Panel and select [Delete]. When uninstalling utility software, use [Add/Remove Programs] in [Control Panel]. Use the Windows standard operation for each case.

PLUG AND PLAY OR ADD PRINTER WIZARD

Before installation

Before installing the printer drivers, check the following items.

Ensure that your computer system meets the following requirements.

Computer

IBM PC/AT or compatible computer

Hardware requirements of the operating system must be satisfied.

Operating system

Windows 95

Windows 98

Windows 2000

Windows NT 4.0

Windows Me

Windows XP

When using Plug and Play or using the Add Printer Wizard to install printer drivers, enter the directory name indicated below as a source directory.

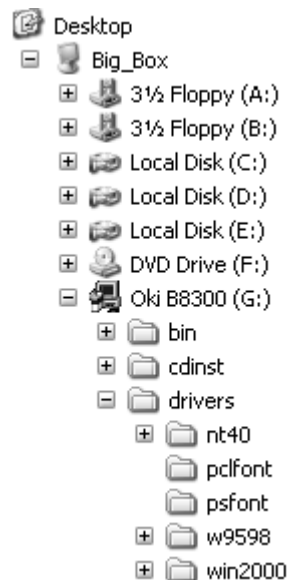

Example of installation of a printer driver using the Add Printer Wizard under Windows 98.

The installation example is described assuming that the printer is connected as a local printer and that the CD-ROM drive is designated as [Drive G]. The procedure may differ depending on the system environment.

1. Start Windows 98.
2. Insert the supplied CD-ROM into the CD-ROM drive. If your computer CD-ROM drive is configured for auto start, the tool selection will appear. Click [Cancel] to close the screen.
3. On the [Start] menu, select [Settings] and then [Printers]. The Printer window will appear.
4. Double-click the [Add Printer] icon.
5. Click the [Next] button.
6. Check the [Local Printer] radio button and then click the [Next] button.
7. Click the [Have Disk] button.
8. The [Install From Disk] dialogue box will appear.



9. Enter the file path as follows:
`G:\OkIB8300\Drivers\English\w9598\pcl5e`
`G:\OkIB8300\Drivers\English\w9598\pcl6`
10. Click the [OK] button.
11. Select the printer model to be used and click the [Next] button. Follow the instructions displayed by the [Add Printer Wizard].

SETTING DRIVERS USING WINDOWS

This section describes the method of changing the printer driver settings from your computer using Windows. If no printer driver has been installed, use the supplied CD-ROM to install it referring to **Installing Printer Drivers And Printer Utilities**.

● Windows 95/98/Me

Screens for Windows 98 are used in the description below.

1. On the [Start] menu, select [Settings] and then [Printers]. The Printer window will appear.



2. Right-click the installed printer driver and select [Properties]. This example is the screen displayed by selecting B8300PCL.
3. See Printer Driver Help for additional information.
4. Click the [OK] button.

● Windows NT 4.0/2000

Screens for Windows NT 4.0 are used in the description below.

1. On the [Start] menu, select [Settings] and then [Printers]. The Printer window will appear.

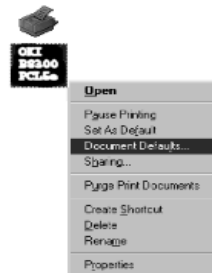

2. Right-click the installed printer driver and select [Document Defaults]. This example is the screen displayed by selecting B8300PCL5e.
3. See Printer Driver Help for additional information.
4. Click the [OK] button.

For the setting concerning optional peripheral devices such as the duplex module, finisher and stand/3 x 500 sheet paper drawer, right-click the installed printer, select [Properties], and then open the [Configuration] tab. If you click the [Get Tray Status] button in the [Detail] dialogue box of the [Paper] tab, the current tray information (paper size, paper type, and quantity of paper remaining) will be displayed.

PRINTER CONFIGURATION THROUGH A NETWORK

If you access the Web pages of this product from your computer using a Web browser such as Internet Explorer or Netscape Navigator various settings can be adjusted through the network.

The following products and computer system requirements are needed for accessing the Web pages of this product.

Print server card (network interface card)

Recommended Web browser

Microsoft Internet Explorer 4.0 or later or equivalent

Netscape Navigator 4.0 or later or equivalent.

- › The following characters cannot be used when setting the pages in the Web server located in this product. Input characters are case-sensitive.

Characters that cannot be input:

< > ”

Examples of improper input:

<abc> <abc “abc” “abc abc”

Accessing Web pages and displaying Help

Use the following procedure to access the Web pages.

If the [Help] button in the menu frame is clicked, the Help screen describing the various function settings that can be operated remotely from the Web pages for this product through the network will appear.

For the setting of each function, see the detailed description.

1. Open the Web browser on your computer.



2. Input the IP Address previously specified for this product into the [Address] field of the browser.

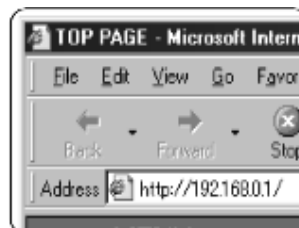

When the connection is completed, the Web page information of this product will be displayed.

3. Click the [Help] button in the menu frame. The configuration settings are described in detail.

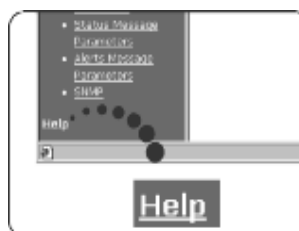

4. Close [Help].



Click the  button. The display will return to the Web page information of this product.

WEB PAGE ITEMS AND FUNCTIONS

ACCESS SETUP

Access restriction to the Web pages is described below.

Network Card Setup

To allow configuring the print server card (network interface card), a link to the network card Web page for is provided.

The Admin password is the same as the Web Page password for the network card.

Password Setup

Password access to the Web pages can be set. Two types of passwords are configurable (user and administrator) . The Admin password is the same as the Web Page password for the network card.

Custom Directory Setup

User index names in the display list on the operator panel are set.

Alerts Message Parameters Setup*

The parameters for the alert message address information are registered here. The alert message is transmitted when a problem such as a supplies requirement (toner or paper) or error(device failure or paper misfeed) occurs.

SNMP Trap Setup

IP addresses, trap community, and authentic community are set here.

Confidential reception

Data to be printed is sent to the machine and held until released for printing from the operator panel.

JOB CONTROL

This section describes the operation procedure required for this function. To use job control in your print job, select [Properties] on the printer driver screen, open the [Main] tab and click [Job Control.] The job hold function can be used only if your printer is equipped with the hard disk drive option.

JOB CONTROL OPERATION

1. Normal print

(In this mode, no input from the operator panel of the printer is needed.)

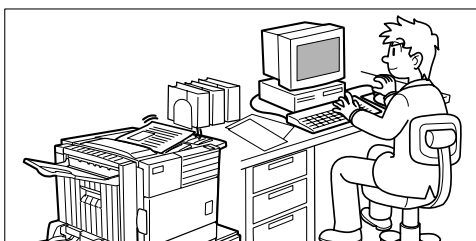

The print setting in this mode is the basic print operation. If no problem occurs with the printer (such as paper misfeed or toner out), the print start operation is completed on the computer and printing will be executed on the printer.

2. Hold after print



In this mode, print data will be held in the Hold Job List even after printing is complete. Printing can be executed again from the operator panel of the printer if needed. Also, the data can be deleted from the operator panel if it is not necessary.

3. Hold before print

This mode can reduce the possibility of missing printout. If printing is made in this mode from the computer, print data will not be output immediately and will be stored in the printer as a held job until released from the operator panel.

A print start operation can be made on the operator panel of the printer as needed. You

can also delete the data without executing printing.

4. Proof print



This mode can prevent a high-volume misprint when many sets must be printed. If printing is executed in this mode, only one set will be printed and the remaining sets will be held as a hold job.

After checking the finished printout, including print position on paper and stapling position, you can start printing of the remaining sets from the operator panel of the printer. You can also delete the data without executing printing.

5. Password (5 digits)

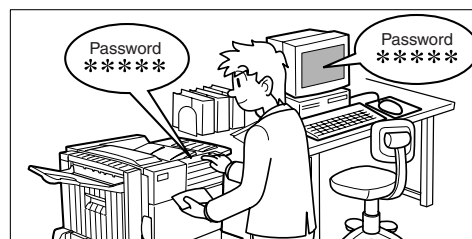

If a password is set in the printer driver setting, a password entry is needed to start printing of a password protected job. This mode can increase the security of hold jobs.

● Hold After Print mode with password:

Password entry on the operator panel of the printer is needed to allow additional printing of held job.

● Hold Before Print mode with password:

Password entry on the operator panel of the printer is needed to start printing.

● Proof Print mode with password:

Password entry on the operator panel of the printer is needed to allow the printing of the remaining sets after printing one set. The first set is printed without password entry.

HOLD JOB LIST

If **Print after hold**, **Print before hold** or **Proof print** operation is performed on the computer, print data will be held as a hold job.

(Up to 100 jobs can be held.

If the main switch is turned off, the stored data of all jobs in hold will be cleared.)

If the number of jobs exceeds 100, the job is processed as follows. A Notice Page will be printed in all cases.

- › If Hold After Print is executed:
Printing will be executed but the job will not be held.
- › If Hold Before Print is executed:
Printing will not be executed and the job will not be held.
- › If Proof Print is executed:
Printing of one set will be executed but the job will not be held.

When the machine is being operated from the operator panel:

1. Press the [MENU] key.

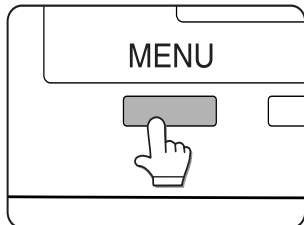

PRINTJOBS ON HOLD will appear in the message display.

2. Press the [OK] key.

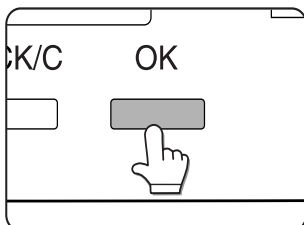

When the [OK] key is pressed, a user name and a file name of the print data stored as a held job will appear.

```
MIKE
WORD-1
```

3. Select the desired data.

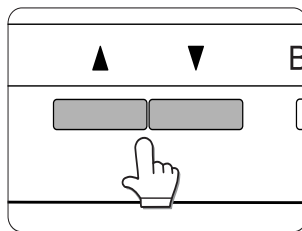

Press the ▲ or ▼ key on the operator panel repeatedly until the desired print job is displayed.

4. Press the [OK] key.
5. Enter the first digit of the password and press the [OK] key. (This is needed only if a password has been set.)

Be sure to enter the same number that has been entered on the computer. If no password has been set, operation of steps 5 and 6 is not needed.

```
PIN
- - - - -
```

When you press the [OK] key to register the first digit after entering it, using the ▲ or ▼ key on the operator panel, “*” will appear and “-” at the second digit will blink. If you press the [BACK/C] key, you can correct the entered number.

- › The password is entered one digit at a time starting with the first digit. The inactive digits are shown as “-”.
6. Use the same procedure as step 5 to enter the password from the second digit to the fifth digit and then press the [OK] key.
 7. Select execution of printing, cancellation of printing or data retention after printing, and then press the [OK] key.

Deletion or retention of data after printing can be selected. Alternatively deletion of data without printing can be selected. Press the ▲ or ▼ key until the desired choice appears.

PRINT AND DELETE DATA - OK? ▼	Data will be deleted after printing.
PRINT AND SAVE DATA - OK? ▼	Data will be held after printing.
DELETE THE DATA OK? ▼	Data will be deleted without printing.

If this item is selected, the operation will be complete. Steps 8 and 9 are not needed.

8. Verify that the desired number of copies is set.

COPIES	10 SET
--------	--------

The number of copies can be changed by using the or key on the operator panel.

9. Press the [OK] key.

Printing will start. If printing of another job is being executed, however, your job will be registered as a print job. Printing of the job will start after preceding jobs are completed.

10. Operation is now complete.

11. To continue operation, repeat steps 1 to 9.

PRINTER ACCOUNT CONTROL

If the key operator program **Auditing Mode** is set, the number of printed pages can be totalled for each account. The accounts for auditing are accounts that have been established with a key operator program for counting the number of pages from the printer.

When executing a print operation from the computer, you must enter an account number on the setting screen of the printer driver. The account number entry screen will be displayed by clicking [Job Control] in the [Main] tab of the printer driver.

When an invalid account number is entered or no account number is entered, if key operator program [Cancel jobs of invalid accounts] has been set, printing will not be performed. To perform printing in any case, disable the program [Cancel jobs of invalid accounts]. In this case, the number of printed pages will be accumulated in [OTHERS].

The job control screen will always appear when a print operation is executed from the printer driver if the [Auto Job Control Review] check box in the [Main] tab of the printer driver is set.

USING THE PRINTER WITH A MACINTOSH

To use the printer in a Mac environment, run the installer program to copy the PPD (PostScript Printer Description) files to your System Folder.

- › NOTE: If this printer is connected to the computer via a cross-over cable, turn on the Mac before turning on this printer. If not, the printer cannot be recognised as a network printer.

PPD files

The PPD files for Macintosh are the files which a Mac refers to when using its LaserWriter printer driver for printing.

OKI PPD Utility

The OKI PPD Utility is used to register account numbers and passwords when the **Auditing Mode** or the **Job Retention Function With Password** is used. This utility is also used to change the registered account numbers and passwords.

Display fonts

The CD-ROM contains display fonts for the Mac. Install these as required.

Display fonts

Minimum system requirements

Computer

Apple Macintosh series

Apple Power Macintosh series

Operating system

Mac OS 8.51 to 9.x

Printer driver

LaserWriter 8 version 8.4.1 or later.

For other conditions such as CPU and RAM capacity, the core requirements of the operating system must be satisfied. Ensure that LaserWriter 8 has been installed in the Mac's [System] folder. If not, install it from the CD-ROM supplied with your computer.

INSTALLING THE UTILITIES

The screens in the Mac OS 9.0 environment are used below as examples. The display varies with the operating system and printer driver versions.

1. Turn on the computer .
2. Insert the supplied Drivers and Manuals CD-ROM into the CD-ROM drive. An icon will appear on the desktop.
3. Close all other applications and double-click the icon on the desktop. The files contained in the CD-ROM will be displayed.
4. Double-click the [Installer] icon. The installer screen will appear.



5. Please see the *Readme* file on the CD-ROM for the latest information on installing the software.
 6. Click [Install] to start the software installation. Once the installer has finished, restart your computer.
- › When uninstalling the PPD files from your computer, select [Custom Remove] in the [Installation type] selection window, select the features to be removed, and click the [Remove] button.

SELECTING THE PRINTER

Follow the procedure below to select the printer.

1. Ensure that the printer is connected to the network to which your computer is connected.
2. Select the [Chooser] from the Apple menu.
3. Click the [LaserWriter 8] icon.

The names of connected printers are displayed in the right hand box. If multiple AppleTalk zones are displayed, select the zone which includes the desired printer.

4. Select the desired printer.

The default printer name of this product is "OKxxxx" (xxxxxx: six alphanumeric characters). The printer name can be changed by adjusting the setting for the network interface card.

5. Click [Create], [Setup] or [Setup . . .] depending on Mac OS version.
 - If you are setting this printer for the first time:
When the [Select a PostScript Printer Description File:] dialogue box appears, select the PPD file name with your printer model name and click [Select].
 - If you are reinstalling the printer:
Click [Auto Setup].
When the [Select a PostScript Printer Description File:] dialogue box appears, select the PPD file name with your printer model name and click [Select].
Click [OK].
Printer configuration will be set automatically.
6. Click the [Close] box to close the [Chooser].

PAPER SETTINGS

1. Select [Page Setup] from the [File] menu of application software.

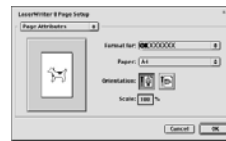

2. Adjust each setting. Paper size, reduction/enlargement, and orientation can be set.
3. Click the [OK] button.

PRINT SETTINGS

1. Select [Print] from the [File] menu of application software. The following display will appear. (The display varies with the operating system versions, printer driver versions, and application software.)



2. Adjust each setting. The following display will appear. Number of copies, page range, and other settings can be made.

If the printer has been configured for **Auditing Mode**, an assigned five-digit account number must be specified. To use the **Job Retention With Password** function, specify a five-digit password.

To select an account number or a password for the **Job Retention** function, select [Job Control] from the pop-up menu

- > Account numbers must be registered on the computer using the PPD utility.
3. Click the [Print] button.

INSTALLING THE DISPLAY FONTS

The display fonts for Macintosh are contained in the [Font] folder of the CD-ROM. Install the display fonts as needed.

Copy the required display font files to the [Fonts] folder in the [System] folder of your computer.

Should any problem occur due to the installation of display fonts, delete the fonts from the system.

USING THE PPD UTILITY

Before using the **Auditing Mode** or the **Job Retention With Password** function from a Macintosh, you must use the PPD Utility to register account numbers and passwords.

This utility allows up to 20 account numbers to be registered for the computer. When printing in the **Auditing Mode**, or using the **Job Retention With Password** function, a password must be specified when printing.

Also, one of the registered account numbers must be specified on the screen used for setting print conditions.

Use the utility to change the registered account numbers.

1. To start this utility, open the [Oki B8300 Extras] folder on your hard disk, and double-click the [B8300 Utility] icon.

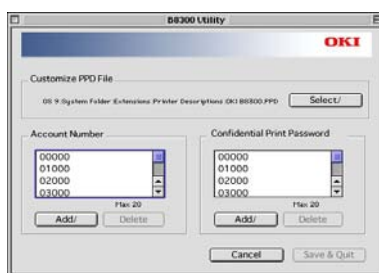

2. Click the [Select] button and select the PPD files for your printer.
3. To register an account number for the computer, click the [Add] button for [Account Number]. The [Account Number] screen will appear. Enter a five-digit account number and click the [OK] button.

To delete a registered security password, select the password in the box and click the [Delete] button.

4. To register a security password for the job retention function, click the [Add] button for [Confidential Print Password]. The [Confidential Print Password] screen will appear. Enter a five-digit number in the box and click the [OK] button.
5. To delete a registered account number, select the account number in the box and click the [Delete] button.
6. To save the registered account numbers and passwords and to exit the utility, click the [Save and Quit] button.
7. If the PPD file is changed using this utility, be sure to select the printer again through the [Chooser]. Use the procedure described in [Selecting the Printer].

CONFIGURATION SETTINGS

There are three basic options that can be set. These are:

Default settings	Basic settings used in printing.
PCL settings	Sets a PCL symbol set.
PostScript settings	Defines whether a PostScript error page is printed or not when a PostScript error has occurred.

OPERATION PROCEDURE COMMON TO ALL PRINTER CONFIGURATION SETTINGS

(Items that can be set from the operator panel)

When the machine is being operated from the operator panel:

1. Press the [MENU] key to display the configuration setting menu screen. Press the [MENU] key repeatedly until the message **CONDITION SETTING** appears.

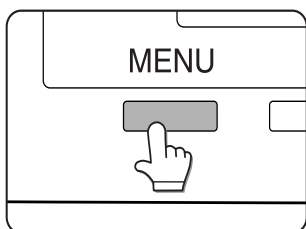

Any print jobs held in the printer and any job currently transmitted to the printer will be printed with the former printer settings.

2. Press the [OK] key.

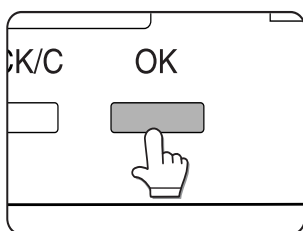

3. Press the ▲ or ▼ key to display the desired setting item.

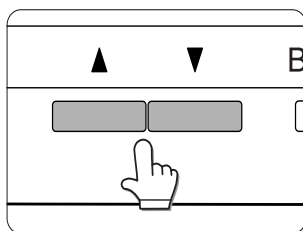

4. Press the [OK] key.

5. Press the ▲ or ▼ key to display the desired setting item.

6. Press the [OK] key.

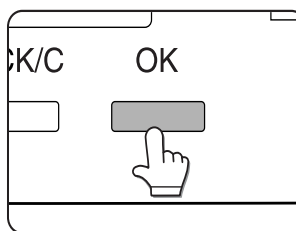

7. When setting is complete, press the [MENU] key to return to the basic screen.

“*” will be displayed to the right of the selected item and setting will be registered.

To set another item, press the [BACK/C] key to return to step 3 and repeat the procedure to step 6.

- > If the [BACK/C] key is pressed after each setting is complete, the display that has called the setting will appear again. If the wrong number is selected, press the [BACK/C] key to select the correct number.

DEFAULT SETTINGS

The default settings allow detailed print conditions to be set for printing without any printer driver (for example, printing from MS-DOS and printing from a computer without any printer driver installed). The setting items are shown below.

While some items can be set either in the printer driver or on the operator panel, values set in the printer driver override those set on the panel. Use the printer driver to set options where possible.

Smoothing

SMOOTHING reduces jagged edges (jaggies). This is seen at roundish curved portions of characters and images to be printed and improves perceived resolution.

Default setting: On

Smoothing on or off can be selected.

Copies

COPIES is set when the number of copies to be printed is set.

Default setting: 1

The number of copies can be set from 1 to 999.

Orientation

ORIENTATION allows portrait or landscape orientation to be selected for printing.

Default setting: PORTRAIT

PORTRAIT or LANDSCAPE can be set.

Default paper size

The paper size to be used for printing under normal conditions is set.

Printing will be performed on to the specified size paper unless otherwise specified.

Default setting: A4 or 8¹/₂ x 11.

(The operator panel on the main unit is used, the sizes are displayed as follows in the display: TABLOID, LEGAL, FOOLSCAP, LETTER, EXECUTIVE, INVOICE, A3, B4, A4, B5, and A5.)

Default paper type

The paper type to be used for printing under normal conditions is set.

Printing will be performed on to the specified type paper unless otherwise selected.

Default setting: PLAIN

Plain paper, pre-printed paper, recycled paper, transparency film, letter head paper, pre-punched paper or colour paper can be set.

Default output tray

The output tray to be used for printing under normal conditions is set. Printed sheets will be output to the specified tray unless otherwise specified by application software.

Default setting: Depends on installation of peripheral devices.

- › The trays that can be selected depend on installation of peripheral devices. This item itself may not be selected.

PCL settings

PCL SETTINGS is used to assign a part of a character code set to characters of a specified country choice within the PCL symbol set. (Used when different symbols are used depending on the country.)

Default setting: "1" (Roman-8)

Two lists can be printed using options available under **LIST PRINT**.

Select the desired symbol set item from the operator panel and register it.

PostScript settings

This setting specifies whether an error page describing the cause of an error is printed or not when a PostScript error has occurred.

Selections are available to choose printing or not printing of error pages.

Default setting: Not print

CUSTOM SETTINGS

Custom settings are used for various settings based on actual operating conditions. The items that can be set with the custom settings are shown below.

Total count	The number of printed pages and similar items are displayed.
List print	Used to print a list of settings that have been made, or a font list.
Clock	The date and time of the built-in clock of the printer can be set.
Tray settings	The paper type and paper size for each tray are set here.
Auto tray switching	Used to automatically switch the paper tray to another tray of the same paper size when paper runs out during continuous printing.

OPERATION PROCEDURE COMMON TO ALL PRINTER CONFIGURATION SETTINGS

(Items that can be set from the operator panel)

When the machine is being operated from the operator panel:

1. Press the [MENU] key to display the custom settings menu screen. Press the [MENU] key repeatedly until **CUSTOM SETTING** appears.

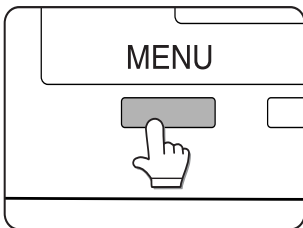

2. Any print jobs held in the printer and any job currently transmitted to the printer will be printed with the former printer settings.
3. Press the [OK] key.

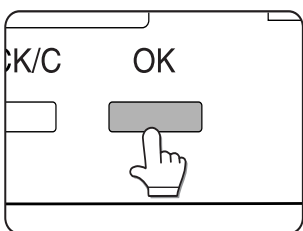

4. Press the ▲ or ▼ key to display the desired setting item.

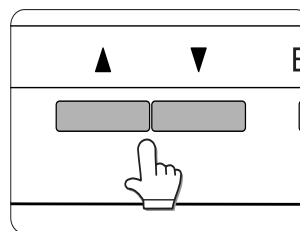

5. Press the [OK] key.
6. Press the ▲ or ▼ key to display the desired setting item.
7. Press the [OK] key. “*” will be displayed to the right of selected item, and the setting will be registered. Depending on the setting item, additional item selection and registration operation may be needed. In this case, use the ▲ or ▼ key to select an item and press the [OK] key to register it. To set another item, press the [BACK/C] key and repeat steps 5 and 6.
 - > When setting is complete, press the [MENU] key to return to the basic screen.
 - > If the [BACK/C] key is pressed after each setting is complete, the display that has called the setting will appear again. If the wrong number is selected, press the [BACK/C] key to select the correct number.

SETTING ITEMS

TOTAL COUNT

The number of total printed pages in this product can be displayed and printed.

LIST PRINT

Test pages such as a list of setting items configured in this product and a list of the resident fonts for checking can be printed. The types of test pages are shown below.

Setting List Print

The settings in the printer feature (condition settings and custom settings) are printed. The key operator program settings are not printed.

Printer test page

- › PCL font list printing.
A list of fonts that can be used with the PCL printer drivers is printed.
- › PCL symbol set printing.
A PCL symbol set list is printed.
- › NIC page printing.
A list of settings used by the NIC (Network Interface Card), namely the print server card, is printed.

- › PostScript font list printing.
A list of fonts that can be used with the PostScript printer driver is printed.

If test page printing is disabled with key operator program **DISABLE TEST PAGE PRINTING**, the printer test pages cannot be printed.

Clock

The date and time of the built-in clock of this product are set. These settings will be used for the functions that require date and time information.

Tray settings

Paper type, paper size, operation mode, and use of automatic tray switching are set for each tray.

Auto tray switching

This item is used to enable the auto tray switching function.

If the auto tray switching function is set and more than one tray of the same paper size is installed in this product, printing can be continued by automatically switching the paper tray when paper runs out.

KEY OPERATOR PROGRAMS

USING THE PROGRAMS

When using the key operator programs for the first time, register a key operator code number.

When the machine is being operated from the operator panel:

1. Press the [MENU] key. Press the [MENU] key repeatedly until the message “KEY OPERATOR PROGRAMS” appears.

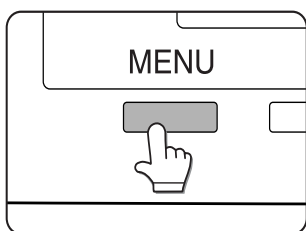

KEY OPERATOR PROGRAMS

2. Press the [OK] key.

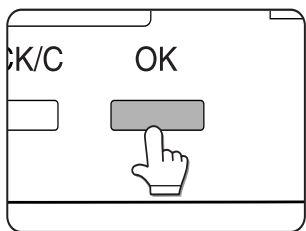

ENTER KEY OPERATOR CODE - - - -

The message shown above will appear.

3. Enter the first digit of your key operator code number and press the [OK] key.

ENTER KEY OPERATOR CODE * - - - -

The factory default setting of the key operator code number is 00000.

The “-” at the first digit will change to “*” and “-” at the second digit will blink. To correct the entered number, press the [BACK/C] key.

4. Use the same procedure as step 3 to enter the key operator code number from the second digit to the fifth digit and then press the [OK] key.

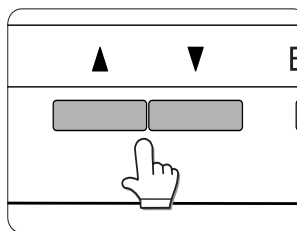

Press the ▲ or ▼ key to select the desired program and press the [OK] key.

For example, to register a key operator code number, select [KEY OPERATOR CODE CHANGE] and press the [OK] key.

5. Press the ▲ or ▼ key to select the desired item.

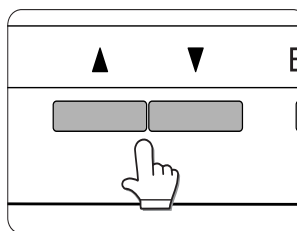

6. To exit the program, press the [MENU] key.

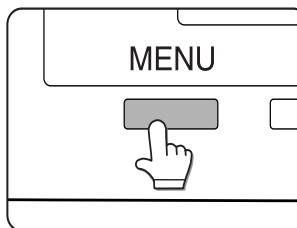

STRUCTURE OF THE SETTING METHOD FOR KEY OPERATOR PROGRAMS

The sequence for selection and setting of key operator programs are shown below. The [OK] and [BACK/C] keys allow navigation in either direction through the setting steps along a program setting path. Program steps start from the major categories shown at the left side of the chart and progress to the right.

When the [OK] key is pressed, a highlighted parameter shown in that step will be accepted and set. Acceptance of a parameter by [OK] will also advance the program to the next step of the setting procedure. When [OK] is pressed to register all settings at the final step of a setting procedure, the total program will be registered and the screen will return to display of the major program categories.

The [BACK/C] key is used to return to the previous screen. Successive pushes of the back key will return step by step back through the setting steps. Settings for any step can be changed by going back and selecting again.

The ▲ or ▼ keys are used to move up and down through selections on a setting screen to highlight a desired selection. A press of the [OK] key will register the highlighted selection.

A setting value on any setting screen containing an asterisk indicates the current registered value for that parameter. If a mistake is made in selection, press the [BACK/C] key to return to the selection screen for correction.

On the chart overleaf, settings accompanied by an asterisk in parentheses (*) indicate the factory default setting for that parameter. To exit the key operator program, press the [MENU] key on the operator panel.

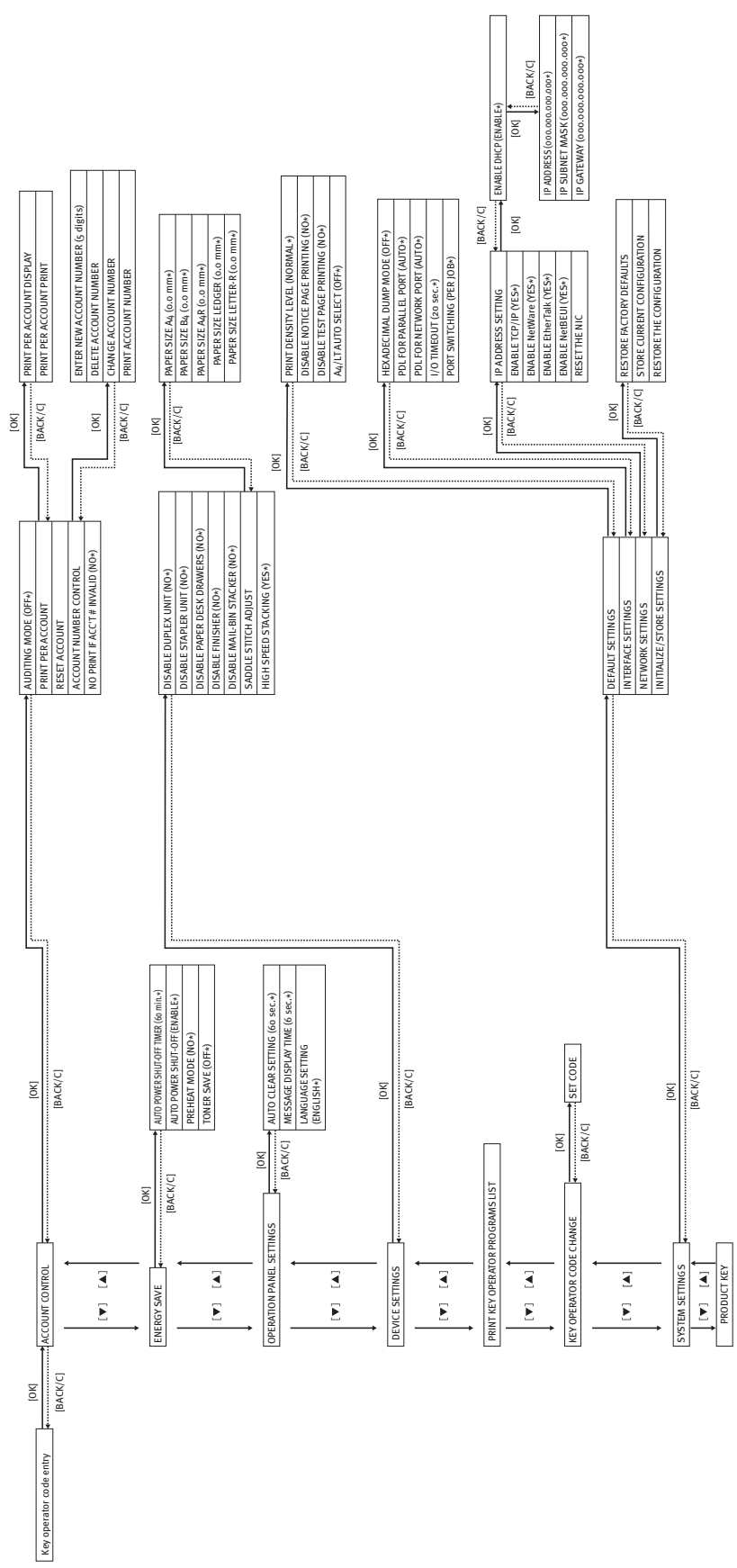

KEY OPERATOR PROGRAMS

This section describes the key operator programs which can be set using the operator panel.

ACCOUNT CONTROL

- The program **Auditing mode** is used to set the internal auditor function. The other programs of this category can be set only if the auditing mode has been enabled.

Auditing mode

When the auditing mode is enabled, up to 100 five-digit account numbers can be registered and assigned to users. An assigned account number must be entered for access to printing.

Print per account

This program is used to display or print the total number of prints against each account number. Misfed pages are not counted.

Reset account

This program is used to reset all or individual audit accounts.

Account number control

- Account numbers must be five digits long and can be registered successively.
- Account numbers can be deleted, changed individually or all at once.
- To change an account number, enter the number to be changed and then enter a new number. This process can be repeated. Changes for unregistered account numbers will not be registered.

No print if ACC'T # invalid

If this program is set in the auditing mode, and an invalid account number is entered or no account number is entered on the computer, printing will be disallowed. If this program is not set, printing will be allowed and the number of prints will be accumulated as "OTHERS" in the print total.

ENERGY SAVE

Two programs are provided to help cut electricity costs, eliminate waste and reduce environmental pollution. In situations where it is impractical to use the Auto power shut-off timer, a program is provided to cancel that function. There is also a program for reducing toner consumption.

Auto power shut-off timer

When a programmed length of time has elapsed without any operation after printing is complete, the printer will enter the auto power shut-off mode to save the maximum amount of energy. The time until auto shut-off occurs can be set to 15, 30, 60, 120 or 240 minutes.

If you use the program **Auto power shut-off** to disable the auto power shutoff mode, the time set with this program will be ignored.

Auto power shut-off

When a programmed length of time has elapsed without any new operation taking place, the printer enters the auto power shut-off mode to save the maximum amount of energy. If it becomes impractical to use this feature, this program can be used to disable it. If disabled, the auto power shut-off time setting will be ignored. We recommend you enable this function to save the environment and costs

Preheat mode

The printer will enter the preheat mode after a programmed length of time has elapsed without any new operation after printing is complete. Set the most appropriate time according to your usage pattern. The time until the printer enters the preheat mode. This function can also be disabled.

Toner save

Printing in toner save mode will reduce toner consumption. If toner save is set, black solid areas will be printed as halftone. (This setting is effective only for printing without use of a printer driver. If the printer driver is used, the printer driver setting will override the setting of this program.)

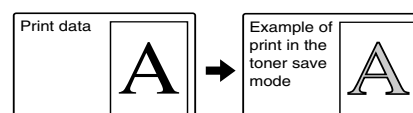

OPERATOR PANEL SETTINGS

These programs are used to adjust the display on the operator panel.

Auto clear setting

The auto clear function will return the printer to standby mode or job status mode after a programmed length of time has elapsed without any operation on the operator panel. Auto clear will not function when the printer is in configuration setting mode, custom setting mode or key operator program setting mode. The auto clear time can be set to 15, 30, 60 seconds or off.

Message display time

This program is used to adjust the time that messages are displayed (for messages that automatically disappear).

The time can be set to 3, 6, 9 or 12 seconds.

Language setting

This program is used to switch the language of messages displayed on the operator panel. The following languages can be selected.

English, French, and Spanish

Use this program to enable or disable the sounding of beeps. Beeps will be sounded when any key is touched and when a communication error has occurred. The beep volume can be set in either of two levels. The default setting is alarm beeps enabled.

DEVICE SETTINGS

These programs are used to enable or disable the use of a peripheral device.

Disable duplex unit

This program is used to disable duplex printing when the duplex module malfunctions. If this program is set, only one-sided printing can be performed.

Disable stapler unit

This program is used to disable stapling when the stapler unit of the finisher or saddle stitch finisher malfunctions.

Disable paper desk drawers

This program is used to disable use of the stand/3 x 500 sheet paper drawer or stand/MPD and 2000 sheet paper drawer when it malfunctions.

Disable finisher

This program is used to disable use of the saddle stitch finisher or finisher when it malfunctions.

Disable mail-bin stacker

This program is used to disable use of the mail-bin stacker when it malfunctions.

Saddle stitch adjust

This program is used to adjust the stapling position (folding position) when using the saddle stitch function of the saddle stitch finisher. The value can be adjusted in 0.1 mm increments within ± 3.0 mm from the reference position for each paper size.

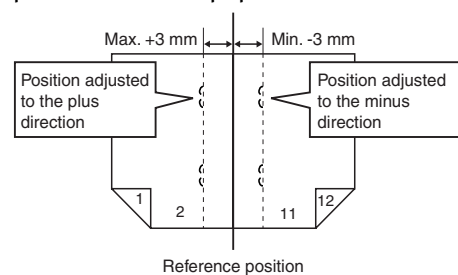

This program is used to set print speed priority, which is available when printing in offset mode using the saddle stitch finisher. When this program is on, a slight decrease in stacking performance might occur.

Print key operator programs list

This program is used to print out the list of the key operator programs.

I/O timeout

This program is used to set the length of time to wait for an I/O to complete a job on the parallel port or the network port.

If the data stream to the port does not transmit data for a length of time exceeding the timeout, the job will cancel and the next job will start processing.

The allowable range of the time is 1 to 999 seconds.

Port switching

This program is used to set the switching method of the parallel port and network port of this printer.

SETTING ITEM	DESCRIPTION
PER JOB	After a print job is completed, automatic port selection state will be restored.
TIMEOUT	After I/O timeout time elapses, automatic port selection state will be restored.
PARALLEL OFF	Printing from the parallel port is disabled.
NETWORK OFF	Printing from the network port is disabled.

NETWORK SETTINGS

These programs are set when this product is used as a network printer.

After each program is set, exit the key operator program, turn off the main switch, and then turn on the main switch again after a while. The program that has been set will be effective at this time.

- › Before setting and modification of any network settings, be sure to consult your network administrator.

IP address setting

When using this product on a network that uses the TCP/IP protocol, use this program to set the IP address (IP address, IP subnet mask, and IP gateway) of this product. The program is set to **ENABLE DHCP** by factory default setting, which has the IP address setting obtained automatically. When using this product on a network that uses the TCP/IP protocol, also set the program **Enable TCP/IP**.

Enable TCP/IP

When using this product on a network that uses the TCP/IP protocol, set this program. Also set the IP address using the program **IP address setting**.

Enable NetWare

When using this product on a network that uses the Novell NetWare protocol, set this program.

Enable EtherTalk

When using this product on a network that uses the EtherTalk protocol, set this program.

Enable NetBEUI

When using this product on a network that uses the NetBEUI protocol, set this program.

Reset the NIC

This program is used to reset all configurable items of the NIC to their factory default settings.

INITIALIZE/STORE SETTINGS

The configuration settings and the system settings of the key operator programs can be stored in memory and be recalled from memory if the settings are changed. These can also be reset to the factory default settings.

Restore factory defaults

This program is used to reset configuration settings, default settings and interface settings of the key operator programs to the factory default settings. If you wish to record the settings before resetting them, use **List Print** of custom settings to print the settings before using this program.

Store current configuration

Use this program to store the current configuration settings, default settings and interface settings of the key operator program in the printer's non-volatile memory. To recall the stored settings, use the program **Restore configuration**.

Restore configuration

Use this program to recall the configuration settings that have been stored in the printer's non-volatile memory by the program **Store current configuration**.

- › After this program is set, exit the key operator program, turn off the main switch, wait at least three seconds and then turn on again. The program will now be effective.
- › If the settings of **Enable TCP/IP**, **Enable NetWare**, **Enable EtherTalk** or **Enable NetBEUI** have been changed, exit the program, turn off the main switch, wait at least three seconds and then turn on again. The changes will now be effective.

KEY OPERATOR CODE

The following is the factory setting of the Key Operator Code Number, which must be used to access the Key Operator program.

Factory setting — 00000

This number must be entered when accessing the Key Operator Program for the first time.

The Key Operator Code Number is an important security number allowing the Key Operator to configure the printer's functions and auditor's settings.

You should register your own code number — different from the factory setting above — immediately after your machine is installed.

TROUBLESHOOTING AND MAINTENANCE

This chapter describes misfeed removal, user maintenance, and similar issues. Please call your authorised dealer if you fail to cure the problem after reading this section.

MISFEED REMOVAL

All messages will appear on the display panel of the main unit. When a misfeed has occurred, printing will stop and the message shown below will appear. Follow the procedure below to remove misfed paper.

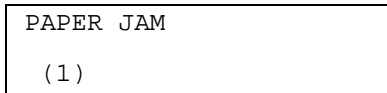

- > CAUTION
- > • Do not damage or touch the photoconductive drum.
- > • Be careful not to tear the misfed paper during removal.
- > • If paper is accidentally torn during removal, be sure to remove all pieces.

CAUTION

The fusing unit is hot. Take care in removing paper.

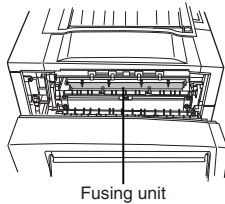

GENERAL MISFEED REMOVAL PROCEDURE

If the INFORMATION key is pressed when a misfeed has occurred, messages will appear giving guidance for misfeed removal. The messages will appear in sequence and can be viewed by using the ▲ and ▼ keys.

Press the **INFORMATION** key.

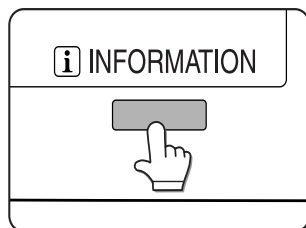

Press the ▼ key.

Use the ▲ and ▼ keys on the operation panel to scroll through the guidance messages.

Press the INFORMATION key to close the misfeed removal guidance.

MISFEED IN THE PAPER FEED AREA

Be sure to follow the misfeed removal sequence. Do not pull the paper tray out first as paper may be located between the paper tray and the paper feed section. If the tray is pulled first, the misfed paper may be torn and difficult to remove.

The following procedure shows the removal sequence when the machine is equipped with a duplex module. If the machine is not equipped with a duplex module or any output device, the procedure is basically the same. The left side of the machine must be opened and cleared before the paper tray is pulled out.

MISFEED IN PAPER TRAY 1

1. Unlatch the duplex module and slide it to the left. Unlatch the module and gently move the module away from the machine. If the machine is not equipped with a duplex module, open the side cover.

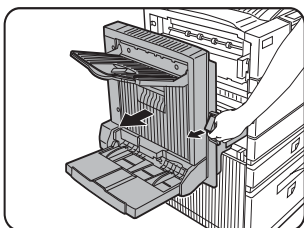

2. Remove the misfed paper. Be careful not to tear the misfed paper during removal. The paper may not be extending out very far from inside the machine but it must be removed. . If this is not possible, go to the next step.

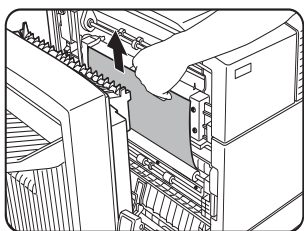

3. If misfed paper is not found in step 2, pull out paper tray 1 and remove the misfed paper carefully.

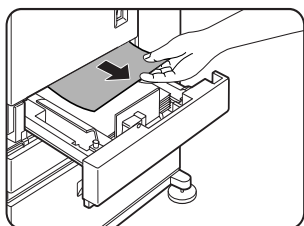

4. Gently close the paper tray. Push the paper tray back into the machine.

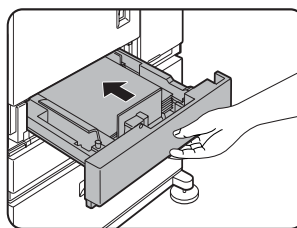

5. Gently close the duplex module. If the machine is not equipped with a duplex module, close the side cover. After closing, confirm that the misfeed message has been cleared and the normal display appears.

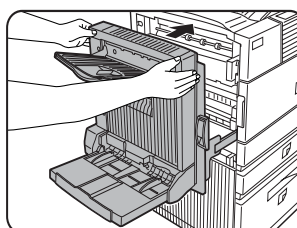

6. If paper drops beyond the rear side of the paper tray that has been pulled out, remove the paper tray and then remove the paper.

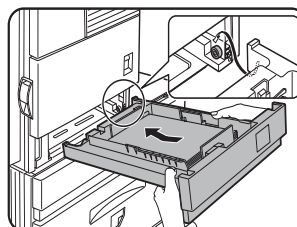

7. After pulling out the paper tray until it stops, gently lift and pull the tray to remove it. To reinstall the paper tray, insert it at an angle and then push it into the machine.
8. To remove a paper tray from a stand/ paper drawer, pull the tray out until it stops then rotate it to the left to disengage it from the stand. When reinstalling it, place the left rear of the drawer into the slot and rotate the drawer to the right and into the stand.

Installation of trays in the stand/3 x 500 sheet paper drawer

The middle and lower trays cannot be installed in the upper tray position and the upper tray cannot be installed to the middle and lower tray positions. (These cannot be pushed into the machine.) Take care not to re-install a tray wrongly after removing it.

MISFEED IN MULTI-PURPOSE DRAWER

1. Unlatch the duplex module, slide it to the left and gently move the module away from the machine. If the machine is not equipped with a duplex module, open the side cover.

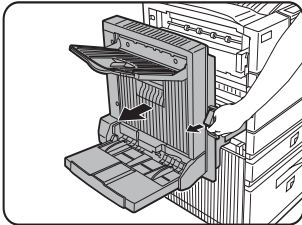

2. Open the left cover of the stand/paper drawer. Hold the knob and gently open the cover. If the machine is not equipped with a stand/ paper drawer, open the left cover of the multi-purpose drawer.

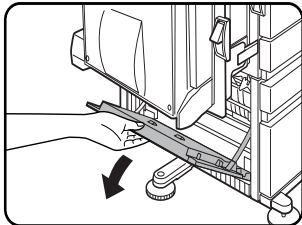

3. Remove the misfed paper. Be careful not to tear the misfed paper during removal. The paper may not be extending out very far from inside the machine but it must be removed. If this is not possible, go to the next step.

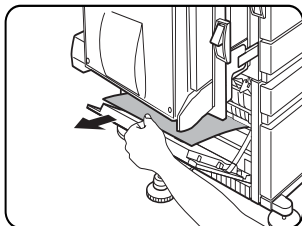

4. Close the left cover of the stand/paper drawer.

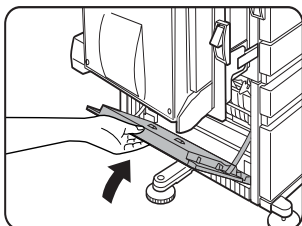

5. Gently close the duplex module. If the machine is not equipped with a duplex module, close the side cover. After closing, confirm that the misfeed

message has been cleared and the normal display appears. If misfed paper is not found in step 3, refer to “Misfeed in paper tray 1” to remove the misfed paper.

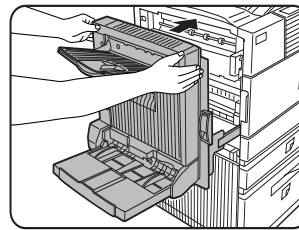

MISFEED IN THE STAND/3 X 500 SHEET PAPER DRAWER

For misfeed removal in the upper tray, follow the procedure of *Misfeed in the multi- purpose drawer* shown to the left to remove the misfed paper.

MISFEED IN THE STAND/MPD AND 2000 SHEET PAPER DRAWER

For misfeed removal in the upper tray, follow the procedure of *Misfeed in the multi- purpose drawer* shown to the left to remove the misfed paper. For misfeed removal in the lower large capacity tray, follow the procedure below. Follow steps 1 to 4 of *Misfeed in the multi- purpose drawer* shown to the left.

1. If misfed paper is not found in step 1, refer to *Misfeed in paper tray 1* on the previous page. If misfed paper is not found in steps 1 and 2, pull out the large capacity tray (lower tray) and remove the misfed paper.

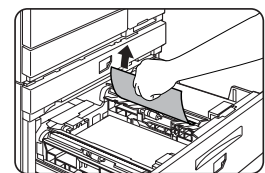
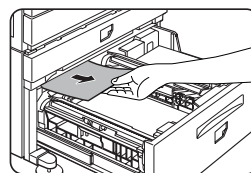

2. Raise the paper guide and remove the misfed paper. After removing the misfed paper, be sure to return the paper guide.

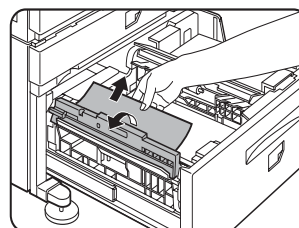

3. Gently close the large capacity tray. Push the paper tray all the way into the machine. Gently close the duplex module.

If the machine is not equipped with a duplex module, close the side cover.

4. After closing, confirm that the misfeed message has been cleared and the normal display appears.

MISFEED IN THE TRANSPORT AREA, FUSING AREA AND EXIT AREA

CAUTION: The fusing unit is hot. Take care when removing paper. Do not touch the metal parts.

1. Unlatch the duplex module and slide it to the left. Gently move the module away from the machine. If the machine is not equipped with a duplex module, open the side cover.

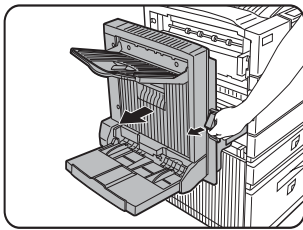

2. Remove the misfed paper as shown. If paper is misfed in the fusing area, turn roller rotating knob A in the direction of the arrow to remove the misfed paper.

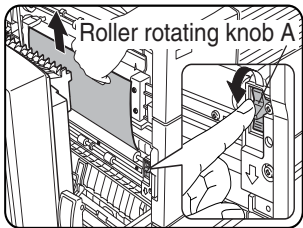

CAUTION: Do not touch or damage the transfer roller or the photo drum.

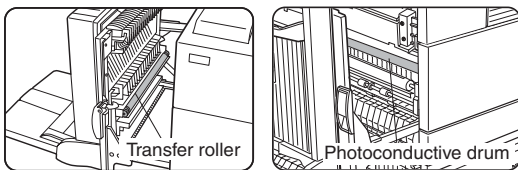

3. If paper is misfed in the transport area, turn roller rotating knob B in the direction of the arrow to remove the misfed paper.

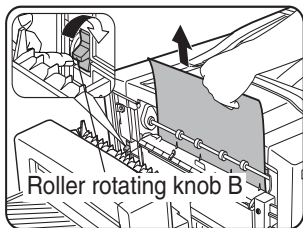

4. If the misfed paper is inside the fusing area, turn down the fusing unit open tab to open the fusing unit and remove the misfed paper.

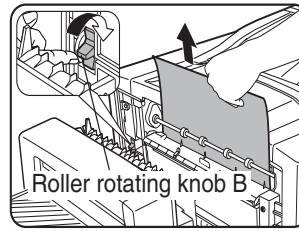

5. If paper is misfed in the exit area, remove it as shown, taking care not to tear the paper.

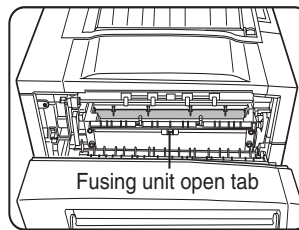

6. If the duplex module is equipped with an exit tray and paper is misfed in the exit area, remove the misfed paper as shown in the illustration.

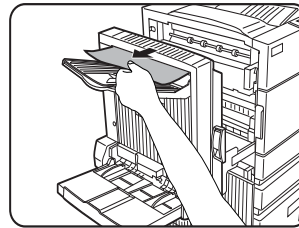

7. Gently close the duplex module.

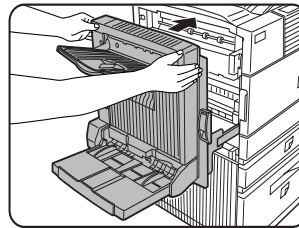

8. If the machine is not equipped with a duplex module, close the side cover.
9. After closing, confirm that the misfeed message has been cleared and the normal display appears.

MISFEED IN THE DUPLEX MODULE

1. Unlatch the duplex module and slide it to the left. Gently move the module away from the machine.

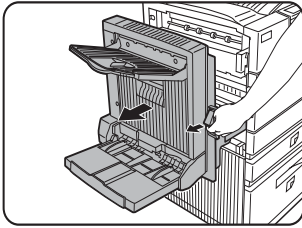

2. If the duplex module has an exit tray, rotate it up out of the way and open the cover of the duplex module. If no exit tray is attached, just open the cover of the duplex module and ignore any reference to the tray in the following steps.

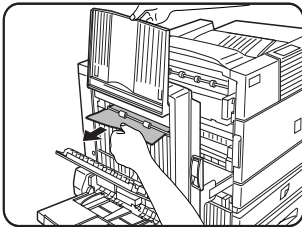

3. While holding the exit tray up, remove the misfed paper. If paper is misfed in the upper part of the duplex module, gently remove it, taking care not to tear the paper. Repeat the procedure if paper is misfed in the lower part of the duplex module. .

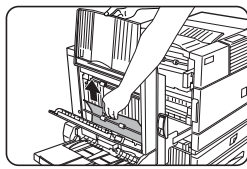
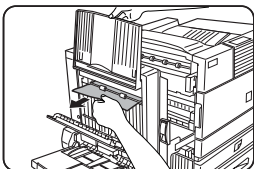

4. Close the cover of the duplex module and lower the exit tray.

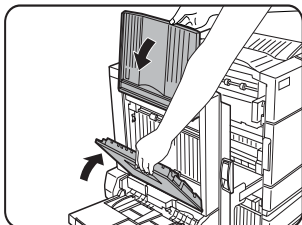

5. Gently close the duplex module.

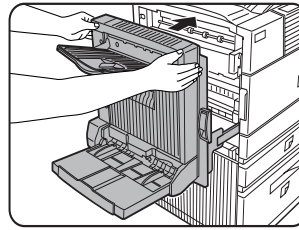

6. After closing the duplex module, confirm that the misfeed message is cleared and that the normal display appears.

MISFEED IN THE BYPASS TRAY

1. Unlatch the duplex module and slide it to the left. Gently move the module away from the machine.

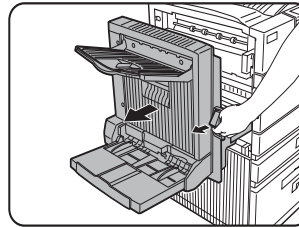

2. Remove the misfeed from the bypass tray. Be careful not to tear the misfed paper during removal.

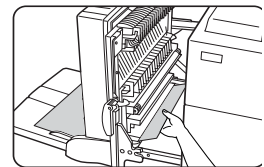
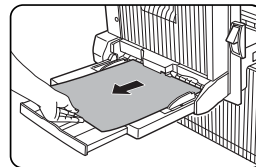

3. Gently close the duplex module. After closing the duplex module, confirm that the misfeed message has been cleared and the normal display appears.

TROUBLESHOOTING

Whenever the printer stops or operation is not possible, check the operation panel display for messages. In most cases these messages will give sufficient information to return the machine to an operating condition. In cases where this information is not enough, check the list below for more information. This section describes problems relating to the printer only. For peripheral issues, see the appropriate sections.

PROBLEM	CHECK	SOLUTION OR CAUSE
Printer does not operate.	Printer plugged in?	Plug the printer into a grounded outlet.
	Main power switch on?	Turn on power switch.
	Message indicating need to load paper displayed?	Load paper.
	Message indicating need to replace the toner cartridge displayed? (ERROR indicator lit at the same time on the operation panel of the main unit?)	Replace the toner cartridge. See the separate operation manual. (Read before installing the product.)
	Message indicating a paper misfeed displayed? [ERROR] indicator lit at the same time on the operation panel of the main unit?)	Remove misfed paper.
Printer is on but data is not received.	Correct interface cable properly connected between the printer and your computer?	Ensure that the correct interface cable is connected between the printer and your computer.
	Correct printer driver installed?	Install the appropriate printer driver.
	Has the printer been selected properly in the application software or, when the printer is being used as a network printer, has it been properly registered on the network?	Ensure that this printer is selected in the application software or use an appropriate utility to check that the printer is registered on the network.
Data is received but not printed.	Is paper of the specified and type loaded in the printer?	Load paper, select another paper size or cancel printing
Printer cannot be selected from computer.	Printer driver installed correctly?	Install the printer driver correctly.
The orientation of the image is incorrect on the print.	Printer driver orientation setting correct?	Correct the orientation in the printer driver.
Image loss has occurred. The image is larger than the paper.	Zoom printing?	Check the zoom setting in the driver.
Black pages.	Colour image data printed?	Some colour on colour images may be printed as all black.
Black and white areas are reversed.	Negative image printing?	Check printer driver setting
Printer prints in reverse order.	Reverse order printing selected in the application software?	Cancel the reverse order printing in the application software.
Printer stops in the middle of a print job.	Too much paper in the exit tray?	Remove paper from exit tray.
	Printer out of paper?	Load paper.
Printing is not on desired paper size.	Paper selection of driver set to [AUTO]?	Ensure that the desired paper is set in a paper tray of the printer and select [Auto] in the paper selection of the printer driver.
Printer resident font cannot be selected from the application.	Resident printer installed?	Install (or reinstall) the resident font information.
Printer write error occurs when printing from the parallel port.	Timeout time set too short in the printer driver?	Set a longer time in the timeout setting in the printer driver.
Only one set has been output when more than one set has been specified.	Size of the file being printed is too large for the available memory? Check for a printed notice page.	The print file size exceeds storage capacity of this printer. Installation of a hard disk drive will enable printing of larger size files.
Two-sided printing is specified but only a notice page is printed.	Two-sided printing of a large number of pages is specified?	The print file size exceeds storage capacity of this printer. Print additional sets one at a time. Installation of a hard disk drive will enable printing of larger size files.
Printed image is too light or too dark.	Exposure control set properly?	The printer exposure level can be adjusted by using a key operator program. Contact your key operator.

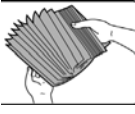
PROBLEM	CHECK	SOLUTION OR CAUSE
Smudges on printed sheets.	Is a message indicating a need of maintenance or replacement of developer cartridge displayed ([ERROR] indicator on the main unit operation panel lit)?	See the Operation Manual (Read this document before installing the product.)
Cannot select the desired paper in the printer driver or on the copier operation panel.	Has the paper size and type been set from the operation panel on the printer?	Be sure to set the paper size referring to <i>Setting the paper size and type</i> when you change the paper size in tray 1.
Paper misfeeds frequently.	Paper curled or damp?	Do not use curled or crimped paper. If you do not use paper for a long time, store paper in its wrapper in a dry location.
	Paper curled and misfed in the duplex module or finisher?	Paper may be curled when output depending on the paper type and quality. In some cases turning the paper over in the tray will reduce misfeeding due to curling
	Multiple sheets of paper fed simultaneously?	 <p>Remove the paper from the paper tray or the bypass tray, fan the paper as shown in the illustration, and then load it again.</p>
Printed paper is wrinkled or the image rubs off easily.	Paper size or weight out of the allowable range?	Use paper in the allowable range.
	Paper damp?	Be sure to store paper in the wrapper in a dry location and do not store paper in a location that is: humid at a high temperature or an extremely low temperature.
The contrast on the touch panel is too high or too low.	LCD contrast properly adjusted?	Adjust the contrast using [DISPLAY CONTRAST] in custom settings.
A notice page is printed when a print job is sent to the printer for retention.	Number of jobs reached the maximum of 100 jobs in retention?	No further jobs can be retained until some jobs already in retention are deleted.
Password entry is requested.	Password set in the retention function?	Password is needed when executing printing. If the password is not known, printing cannot be executed.
Priority of reserved print jobs cannot be changed.	Paper run out?	Load paper.
	Exit tray full?	Remove paper from the exit tray if it is full.

DUPLEX MODULE

If a duplex module is installed, printing on to both sides of paper can be performed. Two types of duplex modules are available: duplex module/bypass tray and duplex module. The descriptions in this manual are for the duplex module/bypass tray.

PART NAMES

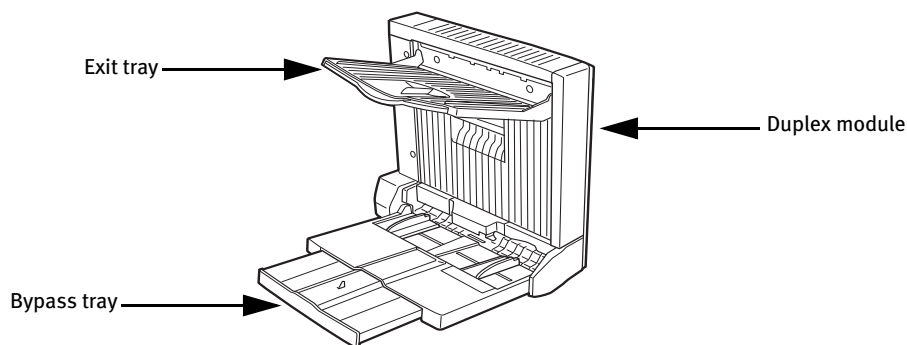

Exit tray The tray is extendable to support large size paper. Extend the tray when 11" x 17", 8½" x 14", 8½" x 13", A3 or B4 paper is being used.

Bypass tray This tray can also be used for special papers including transparency film.

- **Automatic two-sided printing can only be done on plain paper. Special papers cannot be used for two-sided printing.**
- **Do not press down on the bypass tray or the exit tray.**
- **The duplex module requires the installation of other peripheral devices in order to be functional and cannot be installed together with some other devices. See the compatible specifications table.**

SPECIFICATIONS

Name	Duplex module or Duplex module/bypass tray
Paper size (for duplex copy) ¹	11 x 17, 8½ x 14, 8½ x 13, 8½ x 11, 8½ x 11R, 5½ x 8½R, A3, B4, A4, A4R, B5, A5R
Paper weight (for duplex copy) ¹	60 to 105 g/m ² (or 16 to 28 lb)
Reference paper position	Centre
Bypass tray paper capacity ²	100 sheets (A4 or 8½" x 11" size, 80 g/m ² or 20 lb)
Dimensions	Duplex module: 115 mm (W) x 412 mm (D) x 416 mm (H); (4 ¹⁷ / ₃₂ " (W) x 16 ¹⁵ / ₆₄ " (D) x 16-25/ ₆₄ " (H)) Duplex module/bypass tray: 451 mm (W) x 439 mm (D) x 416 mm (H); (17 ⁴⁹ / ₆₄ " (W) x 17 ¹⁹ / ₆₄ " (D) x 16 ²⁵ / ₆₄ " (H))
Weight	Duplex module: approx. 5 kg (11.1 lb) Duplex module/bypass tray: Approx. 7.5 kg (16.6 lb)
¹ For paper size and paper weight for the bypass tray, see <i>Specifications of Paper Trays (Types and Sizes of Applicable Papers for Trays)</i> .	
² Duplex module/bypass tray only.	
Name	Exit tray
Paper output	Print face down
Paper capacity	100 sheets (A4 or 8½" x 11" size, 80 g/m ² or 20 lb)
Paper size	Max. A3 or 11" x 17", Min. or A5R or 5½" x 8½"R
Paper type and weight to be output	Plain paper, 60 to 105 g/m ² (or 16 to 28 lb)
Specifications are subject to change without notice	

LOADING PAPER IN THE BYPASS TRAY

The bypass tray can be used for plain paper and special papers including labels. Up to 100 sheets of standard paper can be set. If the paper type or size is changed, be sure to enter the paper type and size as in step 4.

1. Open the bypass tray.

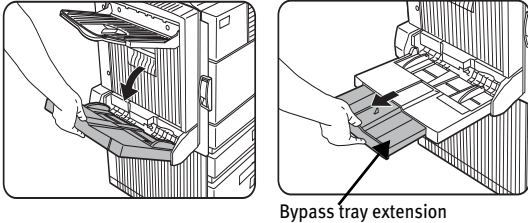

When setting 11"x 17", 8½" x 14", 8½" x 13, A3 or B4 paper, be sure to extend the bypass tray extension.

2. Set the bypass tray paper guides to the width of the paper to be used.

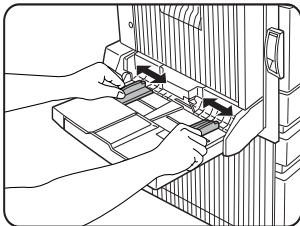

3. Insert the paper all the way into the bypass tray. Set the paper face down. If there is a clearance between the paper and the paper guides, the paper may not be fed correctly. Adjust the guides so that they contact the edges of the paper.

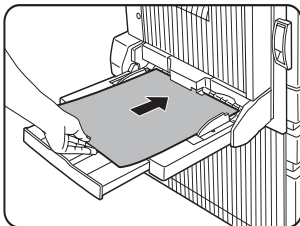

4. Use the operator panel to set the type and size of loaded paper. When the paper system is changed from the inch system to the AB system or vice versa or when the paper type is changed, the paper type must be designated.
5. Loading paper in the bypass tray is now complete.

NOTES

- When using A5, 5½" x 8½" paper or postcards, be sure to load them with their shorter edge into the feed slot as shown in the illustration below.

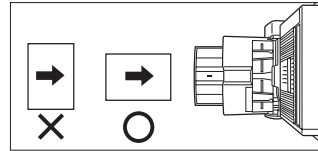

- When using special paper, postcards or transparency film, be sure to feed them one sheet at a time. If you set more than one sheet, a paper misfeed may occur.
- When adding paper, first remove remaining paper, combine it with the paper to be added, and then reload as a single stack. Adding paper without stacking it correctly may cause a paper misfeed.
- When printing on to transparency film, remove the output sheets as soon as possible.
- For transparency film, use Oki recommended film.

SETTING THE PRINTER DRIVER FOR DUPLEX MODULE, BYPASS TRAY AND EXIT TRAY

When using the duplex module (including the bypass tray and the exit tray) for printing, select “Properties” and make selections as follows for the print job.

The screens used in the following descriptions are for a PCL driver in the Windows 98 environment.

Two-sided printing

Open the “Main” tab and check the radio button of the desired two-sided printing mode.

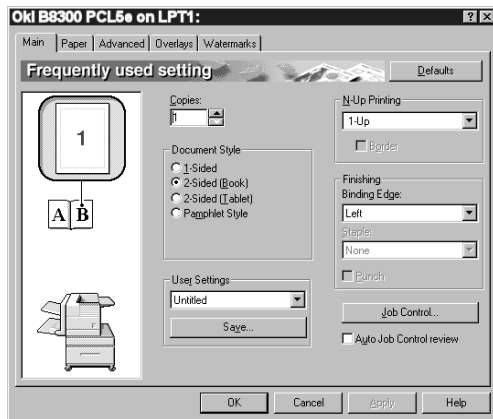

Using the bypass tray

Open the “Paper” tab shown in the illustration below and select “Bypass Tray” in the “Paper Selection” drop down.

Using the exit tray mounted to the duplex module

Open the “Paper” tab shown in the illustration below and select “Left Side Tray” in the “Output” drop down.

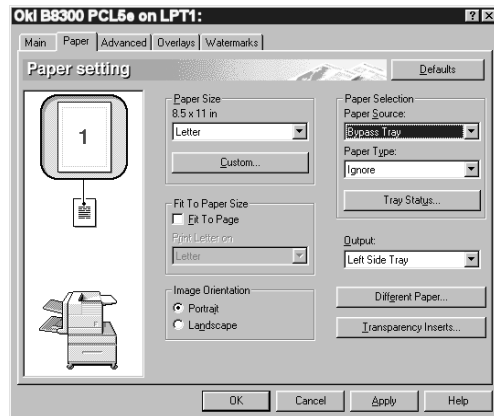

The settings screens shown will appear only if the devices have been set properly in the printer driver configuration.

The combination of paper selection and other functions may not be compatible. For instance, if heavy paper, envelopes, label stock, etc. are selected, it will not be possible to select duplex, offset tray, saddle stitch, etc.

TROUBLESHOOTING THE DUPLEX MODULE

Check the list below before calling for service..

PROBLEM	CHECK	CAUSE OR SOLUTION
The printer will not print duplex prints.	Message indicating the paper type cannot be used for two-sided printing displayed?	Special paper cannot be used for two-sided printing. Use a paper type suitable for two-sided printing.
	Message indicating the paper size cannot be used for two-sided printing displayed?	Use a paper size suitable for two-sided printing.
	Two-sided printing cannot be set in printing on the printer driver?	Open the Configuration tab in the printer driver setting and select the check box of Duplex Module.
	Bypass tray extension not extended?	When using 11 x 17, 8½ x 14, 8½ x 13, A3 or B4 paper, the bypass tray extension must be extended.
Printed images on to paper from the bypass tray are skewed.	Does the number of sheets exceed the limit?	Set paper within the allowable range.
	Paper guides properly set?	Set the paper guides properly to the paper size.
A paper misfeed occurs in the bypass tray.	Paper size and type properly set ?	When using non-standard size paper or special paper, be sure to set the paper size and type.
	Does the number of sheets exceed the limit?	Set paper within the allowable range.
	Paper guides properly set?	Set the paper guides properly to the paper size.

MAIL-BIN STACKER

The mail-bin stacker has seven mail bins which can each be designated to receive printed output from a user or a group of users.

PART NAMES

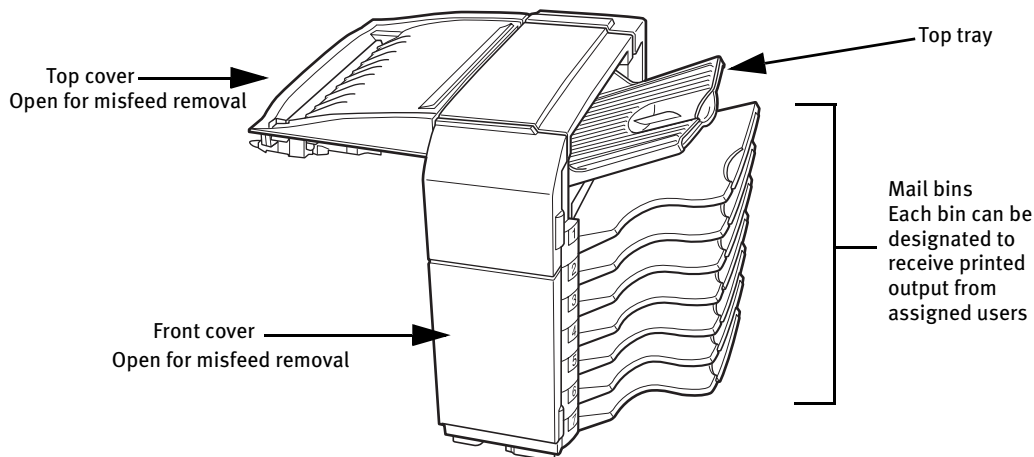

- Do not put pressure on the mail-bin stacker, particularly on the top tray and mail bins.
- Do not place anything on the top cover.
Doing so will interfere with the machine's paper handling during duplex printing.
- The top tray and each mail bin are extendable. To print on to large paper (11" x 17", 8½" x 14", 8½" x 13", A3 or B4), extend the tray.
- The mail-bin stacker requires the installation of other peripheral devices in order to be functional and cannot be installed together with some other devices.

SPECIFICATIONS

Name	Mail-bin stacker
Number of trays	Eight (Top tray and seven mail bins)
Paper output	Print face down
Tray type	Top tray: normal tray, Mail bins: mail bin tray
Tray capacity	Top tray: 250 sheets (A4 or 8½" x 11" size, 80 g/m ² or 20 lb) Mail bins: 100 sheets each (A4 or 8½" x 11", 80 g/m ² or 20 lb)
Paper sizes	Top tray: same as the specifications of paper for feeding in the main unit. Mail bins: 11 x 17, 8½ x 14, 8½ x 13, 8½ x 11, 8½ x 11R, 7¼ x 10½, A3, B4, A4, A4R, B5, B5R
Paper weight	Top tray: same as the specifications of paper for feeding in the main unit Mail bins: 60 to 105 g/m ² or 15 to 34 lb
Paper types	Top tray: same as the specifications of paper for feeding in the main unit Mail bins: plain paper only
Tray full detection	Provided in both the top tray and the mail bins
Power supply	Requires the installation of an optional power supply unit
Dimensions	465 mm (W) x 530 mm (D) x 508 mm(H); (18 ⁵ / ₁₆ " (W) x 20 ⁷ / ₈ " (D) x 20" (H))
Weight	Approx. 19 kg (41.9 lb)
	Specifications are subject to change without notice

SPECIFYING MAIL BINS TO RECEIVE PRINTED OUTPUT

Printed output can be specified in the printer driver to be delivered to an assigned mail bin or to the top tray. Assigning mail bins to individual users or groups of users reduces the mixing of print jobs simplifying the retrieval of printed output. When separation of output is not required, the top tray can be selected for delivery.

Using the mail-bin stacker

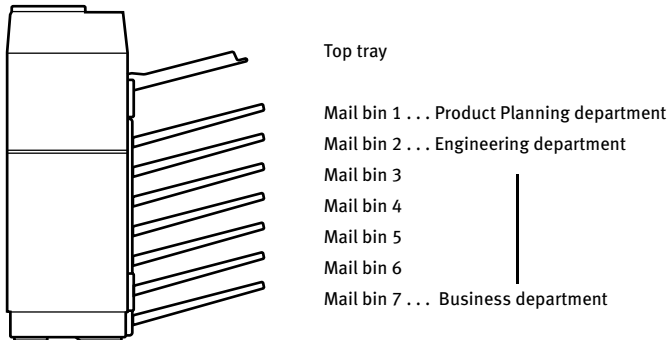

Assign users to mail bins

It is recommended that the network administrator assign bins by individual or by department. For example, the Product Planning department can be assigned to mail bin 1 and the Engineering department assigned to mail bin 2, etc.

1. Select the mail bin for receiving prints in the printer driver. The illustration below shows the screen for a PCL printer driver in the Windows 98 environment as an example.
2. Select “Properties” in the printer driver setting screen and proceed as below.

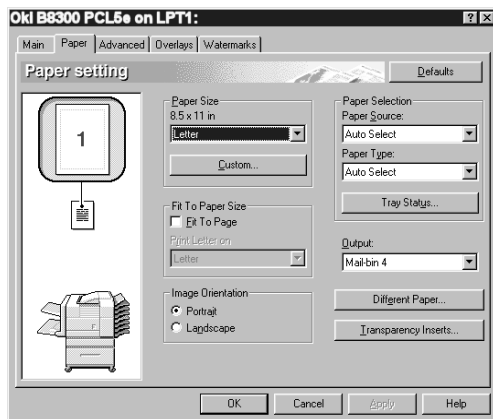

Specifying a mail bin

3. Open the “Paper” tab and select a mail bin for delivery under “Output”.
- The settings screens to the right will appear only if the devices have been set properly in the printer driver configuration.
 - The combination of paper selection and other functions may not be compatible. For instance, if heavy paper, envelopes, label stock, etc. are selected, it will not be possible to select duplex, offset tray, saddle stitch, etc. For details, see printer driver help.

MISFEED IN THE MAIL-BIN STACKER

If a misfeed has occurred in the mail-bin stacker during printing, remove the misfed paper following the procedure below.

1. Open the top cover.

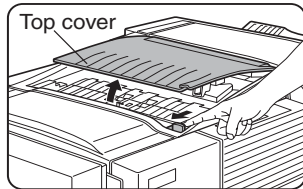

Move the release lever in the direction of the arrow in the illustration to open the top cover.

2. Remove the misfed paper. Be careful not to tear the misfed paper during removal. After removing the paper, press down on the top cover to close it.

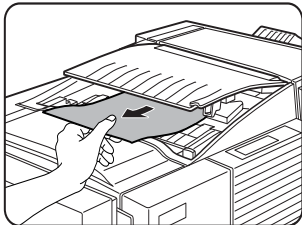

3. If the misfed paper is not found in step 2, open the front cover.

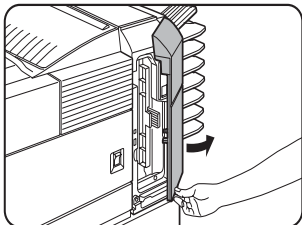

4. Turn the roller rotating knob in the direction of the arrow to remove the misfed paper.
5. Open the paper guide. Unlatch the paper guide and open it in the direction of the arrow.

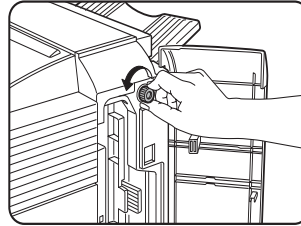

6. Remove the misfed paper. Be careful not to tear the paper during removal.

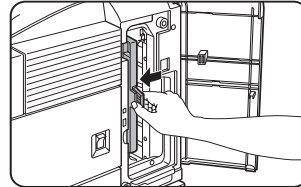

7. Close the paper guide securely..

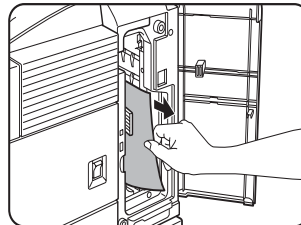

8. Close the front cover.

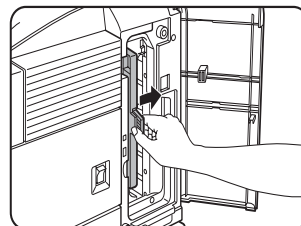

FINISHER

The finisher can deliver collated sets either stapled or unstapled. Unstapled sets can be offset stacked from the previous set for easy separation of the sets.

PART NAMES

Staple box
Pull the box out to replace the staple cartridge or to remove jammed staples.

Latch
Release the latch to open the finisher for misfeed removal.

Top tray
Extend tray to print on to large paper.

Top cover
Open for misfeed removal.

Offset tray
Stapled sets or sets to be offset will be delivered here.

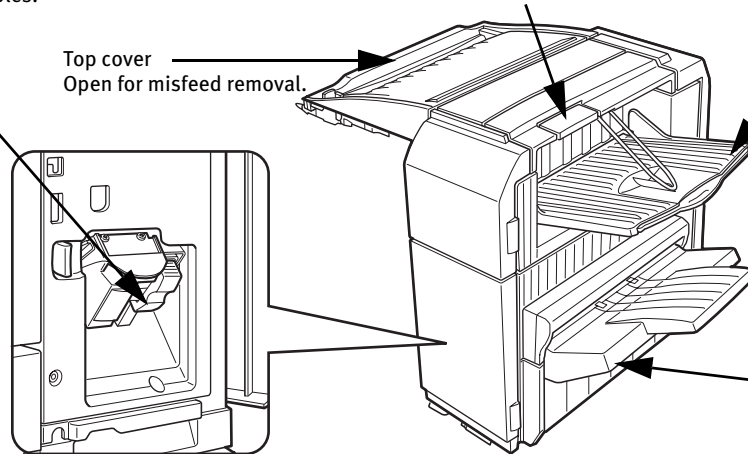

- Do not put pressure on the finisher (particularly each tray).
- Do not place anything on the top cover. Doing so will interfere with the machine's paper handling during duplex printing.
- The tray moves up and down during operation. Be careful not to impede its movement.
- The finisher requires the installation of other peripheral devices in order to be functional and cannot be installed together with some other devices.

SPECIFICATIONS

Name	Finisher
Number of trays	Two
Paper output	Print face down
Tray type	Top tray: normal tray, Lower tray: offset tray
Tray capacity	Top tray: 500 sheets (A4 or 8½" x 11" size, 80 g/m ² or 20 lb) Lower tray: 750 sheets (A4 or 8½" x 11", 80 g/m ² or 20 lb)
Paper sizes	Top tray: same as the specifications of paper for feeding in the main unit Lower tray: Max. A4 or 8½" x 11", Min. B5
Paper weight	Top tray: same as the specifications of paper for feeding in the main unit Lower tray: 60 to 105 g/m ² or 15 to 34 lb
Paper types	Top tray: same as the specifications of paper for feeding in the main unit Lower tray: plain paper only
Tray full detection	Provided in both the top tray and the lower tray
Offset function	Provided for the lower tray only. The offset amount is approx. 25 mm (1 inch)
Paper sizes for stapling	8½" x 11", A4, and B5 30 sheets* (A4, 8½" x 11" or smaller, 80 g/m ² or 20 lb)
Stapling capacity	30 sheets* (A4 or 8½" x 11" or smaller, 80 g/m ² or 20 lb) Up two sheets of cover stock (128 g/m ² or 34 lb) can be included
Staples	Single staple can be placed in the top left or lower left corners or two staples can be centred on the left side
Power supply	Requires the installation of an optional power supply unit
Dimensions	465 mm (W) x 530 mm (D) x 508 mm(H); (18 ¹ / ₈ " (W) x 20 ⁷ / ₈ " (D) x 20" (H))
Weight	Approx. 21 kg (46.3 lb)
	Specifications are subject to change without notice

B8300-FNR staple cartridges must be used for this finisher. The cartridge package contains three cartridges containing approx. 3000 staples each.

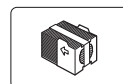

FINISHER FUNCTIONS

- **Sort mode**

Sorted sets will be delivered.

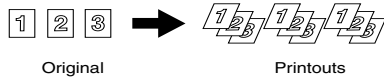

- **Group mode**

Groups of prints or copies of the same page will be delivered.

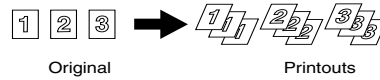

- **Offset mode**

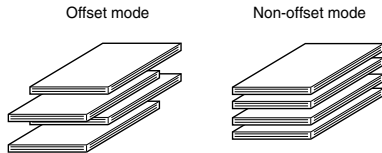

Sets will move from side to side so that each set or group will be offset from the previous set or group for easy separation.

Offset will function for non-stapled printer output.

Stapled sets will not be offset.

- **Staple sort mode**

Collated sets will be stapled and delivered to the offset tray. The stapling positions, orientation, paper size for stapling, and stapling capacity are shown below.

STAPLING POSITIONS	PORTRAIT ORIENTATION		LANDSCAPE ORIENTATION	
Top left corner of printouts		Available paper sizes: 8½" x 11", A4 and B5	—	Stapling not possible
Centre left two positions of printouts		Same as above		
Lower left corner of printouts		Same as above		

USING THE FINISHER FUNCTIONS

- **Selecting the stapling function from a printer driver.**

1. Select "Properties" on the printer driver setting screen and open the "Main" tab.
2. Select "Left", "Right" or "Top" under "Binding Edge"
3. Select "1 Staple" or "2 Staples" under "Staple".

The settings screens to the right will appear only if the devices have been set properly in the printer driver configuration. This example screen is for a Windows 98 PCL printer driver.

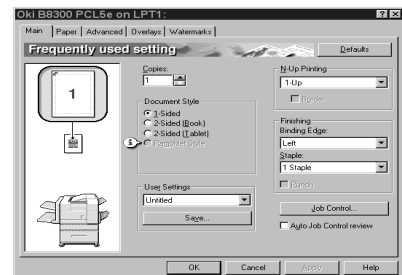

The combination of paper selection and other functions may not be compatible. For instance, if heavy paper, envelopes, label stock, etc. are selected, it will not be possible to select duplex, offset tray, saddle stitch, etc. For details, see printer driver help.

STAPLE CARTRIDGE REPLACEMENT

When the staple cartridge becomes empty, the message “Add staples.” will appear in the message display of the operation panel.

Follow the procedure below to replace the staple cartridge.

1. Open the front cover.

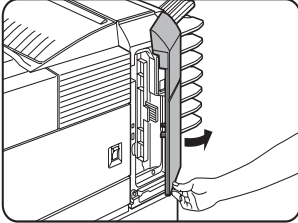

2. Turn the staple unit face up.

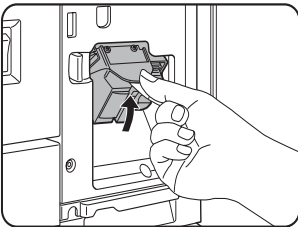

3. Pull the release lever for the staple box and remove the box.

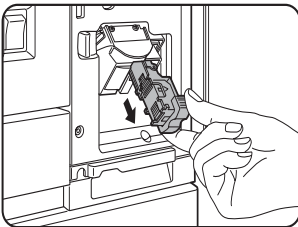

4. Remove the empty staple cartridge from the staple box.

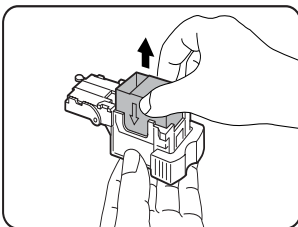

5. Insert a new staple cartridge into the staple box aligning the arrow of the staple cartridge with that of the staple box.

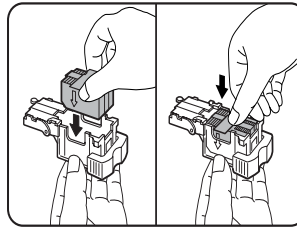

NOTES:

- › Do not remove the tape from the cartridge before inserting the staple cartridge into the box.
 - › When reinstalling the staple box, push it in until it clicks into place.
6. Remove the tape from the staple cartridge by pulling it straight.

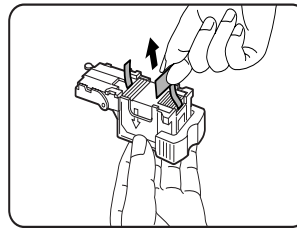

7. Reinstall the staple box. Push the staple box in until it clicks into place.

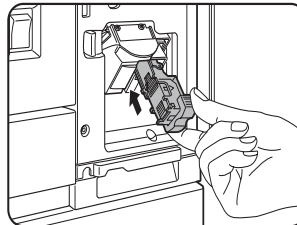

8. While pushing the staple unit release lever to the left, rotate the staple unit to face down.

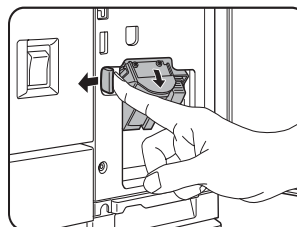

9. Close the front cover.

Make a test print or copy in staple sort mode to ensure that stapling is performed properly.

CHECKING THE STAPLER UNIT

If the message [CHECK THE STAPLER UNIT] or [CHECK STAPLER POSITION OR STAPLE JAM] appears, follow the procedure below.

1. Release the latch to open the finisher compiler.

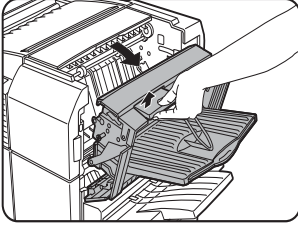

2. Remove the misfed paper from the stapler compiler. Be careful not to tear the misfed paper during removal.

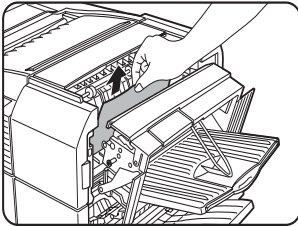

3. Close the finisher compiler

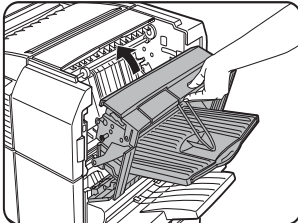

4. Open the finisher front cover.

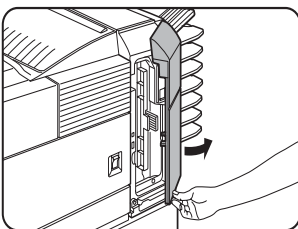

5. Turn the staple unit face up.

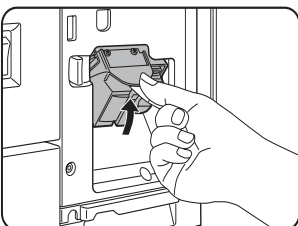

6. Pull the release lever for the staple box and remove the box.

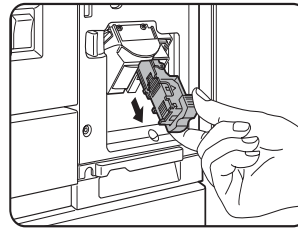

7. Raise the lever at the end of the staple box. Remove the top staple if it is bent. If bent staples remain, a staple jam will occur again..

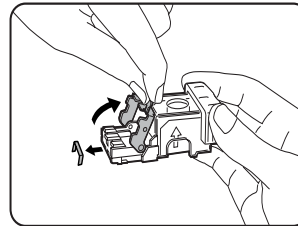

8. Return the lever to its original position.

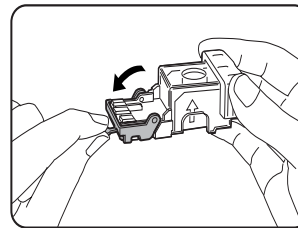

9. Reinstall the staple box. Push the staple box in until it clicks into place.

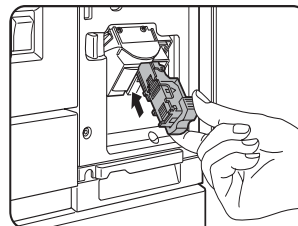

10. While pushing the staple unit release lever to the left, rotate the staple unit to face down.

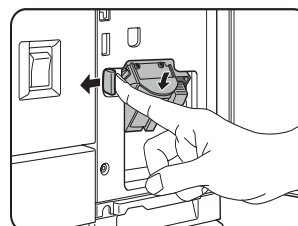

11. Close the front cover.

Make a test print in staple sort mode to ensure that stapling is performed properly.

MISFEED IN THE FINISHER

When a misfeed occurs in the finisher, remove the misfed paper following the procedure below.

1. Remove the misfed paper from the output area. Be careful not to tear the misfed paper during removal.

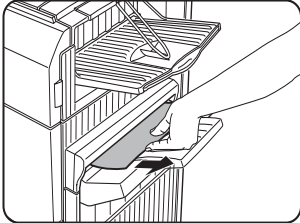

2. Open the finisher top cover. Move the tab in the direction of the arrow as shown in the illustration to open the top cover..

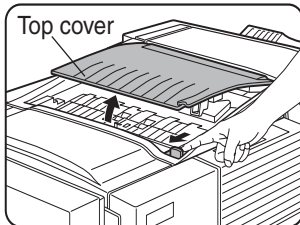

3. Remove the misfed paper.

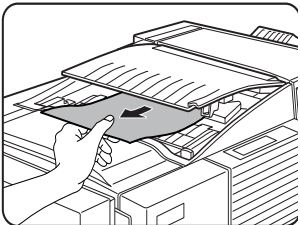

Be careful not to tear the misfed paper during removal. After removing the paper, press down on the top cover to close it.

4. Release the latch to open the finisher compiler.

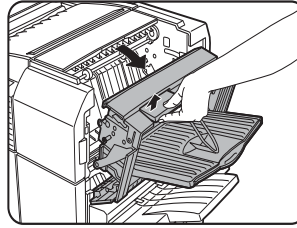

5. Raise the paper guide and remove the misfed paper.

Do not remove paper from the stapler compiler.

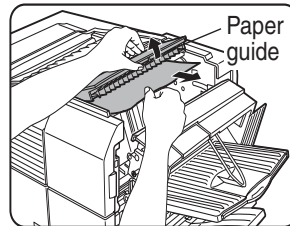

6. Close the finisher compiler.

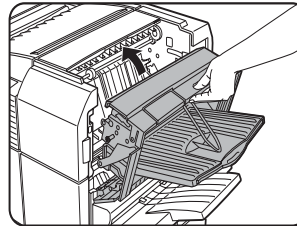

TROUBLESHOOTING FINISHER PROBLEMS

Check the list below before calling for service.

PROBLEM	CHECK	CAUSE OR SOLUTION OR
Stapling position is not correct.	Stapling position not set correctly?	Check the stapling position setting.
The finisher does not operate.	Are any finisher covers open?	Close all covers.
	Message indicating need to remove paper from the stapler compiler displayed?	Open the finisher and remove all paper from the stapler compiler. 
Stapling cannot be performed.	Is a [CHECK THE STAPLER UNIT] or [CHECK STAPLER POSITION OR STAPLE JAM] message displayed?	Check the staple unit.
	Is a message [ADD STAPLES] displayed?	Replace the staple cartridge.
	Different size paper included?	Stapling cannot be performed on to different size paper.
Stapled sets are not stacked correctly or some sheets in a set are not stapled.	Paper heavily curled?	Paper may be curled heavily depending on the paper type and quality. Remove paper from the paper tray or the bypass tray, turn it upside down, and load it again.

STAPLING POSITION QUICK REFERENCE GUIDE FOR DUPLEX OUTPUT

The orientation of the printed copy and the binding position selection are all interrelated. The table below shows these relationships.

		Orientation of original or original data			Output result	
		Page 1	Page 2	Page 1 & Page 2 Duplexed		
Portrait orientation printing	Left binding				One-position stapling 	Two-position stapling
	Top binding				One-position stapling 	Two-position stapling with top binding cannot be made.
	Right binding				One-position stapling 	Two-position stapling
Landscape orientation printing	Left binding				One-position stapling 	Two-position stapling with left binding cannot be made.
	Top binding				One-position stapling 	Two-position stapling
	Right binding				One-position stapling 	Two-position stapling with right binding cannot be made.

NOTES

- › Stapling can only be done when the offset tray has been selected.
- › If mixed paper sizes are selected for stapling jobs, stapling will be automatically cancelled.
- › Transparency film, labels, envelopes and postcards cannot be stapled.

SADDLE STITCH FINISHER

The saddle stitch finisher can automatically place two staples for centreline binding of prints and fold them along the centreline. An optional hole punching unit is available for installation into the finisher.

PART NAMES

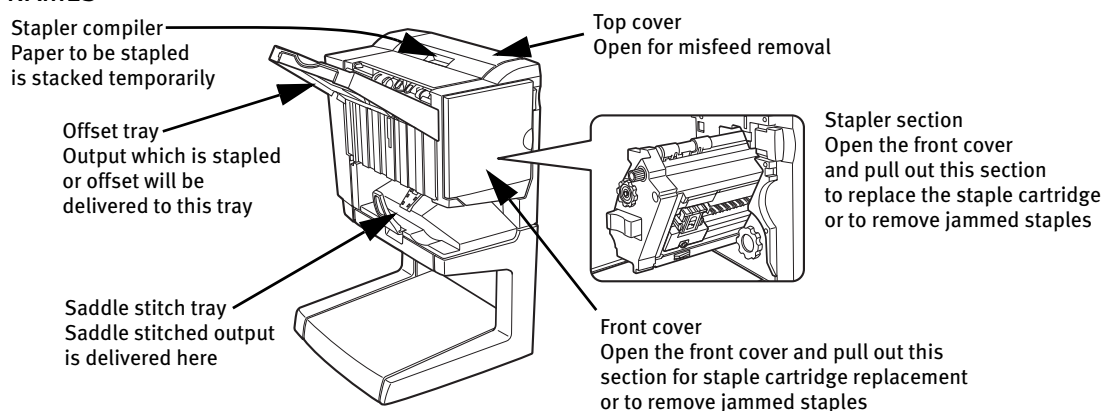

- Do not press on the saddle stitch finisher (particularly the offset tray).
- Be aware that the offset tray moves up and down during printing. Take care not to obstruct the tray.
- Check the correct configuration requirement for the installation of the saddle stitch finisher. Certain configurations will not work.

SPECIFICATIONS

Name	Saddle stitch finisher
Number of trays	Two
Paper output	Print face down
Tray system	Upper tray: offset tray, Lower tray: saddle stitch tray
Tray capacity	Upper tray: Non-stapling: Max. 1,000 sheets for A4 or 8½ x 11 or smaller sizes (80 g/m ² or 20 lb), max. 500 sheets for 8½ x 13 or B4 or larger sizes (80 g/m ² or 20 lb) Stapling: Max. 30 stapled sets and max. 1,000 sheets for A4 or 8½ x 11 or smaller sizes (80 g/m ² or 20 lb), max. 30 stapled sets and max. 500 sheets for 8½ x 13 or B4 or larger sizes (80 g/m ² or 20 lb) Lower tray: Stapled print capacity is (6-10) sheets x 10 sets or (1-5) sheets x 20 sets.
Paper size	Upper tray: 11 x 17, 8½ x 14, 8½ x 13, 8½ x 11, 8½ x 11R, 7¼ x 10½, 5½ x 8½R, A3, B4, A4, A4R, B5, B5R, A5R Lower tray: max. 11 x 17, 8½ x 11R, A3, B4, A4R
Paper weight	Upper tray: 60 to 205 g/m ² or 16 to 54 lb Lower tray: 64 to 80 g/m ² or 17 to 34 lb
Paper types	Upper tray: plain paper, thick paper Lower tray: plain paper only
Tray full detection	Provided in both trays
Offset function	Upper tray only
Paper sizes for stapling	11" x 17", 8½" x 14", 8½" x 13", 8½" x 11", 8½" x 11"R, A3, B4, A4, A4R, B5, and B5R Lower tray: 11" x 17", 8½" x 11"R, A3, B4, and A4R
Stapling capacity	A4 or 8½" x 11" or smaller size: 50 sheets*(80 g/m ² or 20 lb) 8½" x 14" or B4 or larger size: 25 sheets*(80 g/m ² or 20 lb) *Up to two sheets of 128 g/m ² or 34 lb paper can be included as covers
Staples	Upper tray: Single staple can be placed in the top left or lower left corners or two staples can be centred on the left side Lower tray: 120 mm (4 ⁷ / ₆₄ ") pitch from the centre of paper
Power supply	Requires the installation of an optional power supply unit
Dimensions	718 mm (W) x 603 mm (D) x 1000 mm (H) (28 ⁹ / ₃₂ " (W) x 23 ³ / ₄ " (D) x 39 ³ / ₈ " (H))
Weight	Approx. 39 kg (86 lb)
Name	Punch module
Number of holes/hole diameter	Three holes: 6.5 mm or 17/64"
	Specifications are subject to change without notice

SUPPLIES

B8300-SSF staple cartridges must be used for this finisher. The cartridge package contains three cartridges containing approx. 5000 staples each.

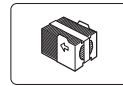

SADDLE STITCH FINISHER FUNCTIONS

● Sort mode

Sorted sets will be delivered.

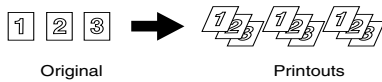

● Group mode

Groups of prints or copies of the same page will be delivered.

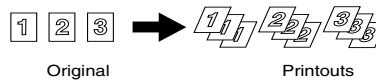

● Offset mode

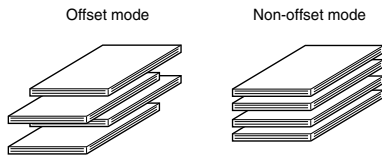

Sets will move from side to side so that each set or group will be offset from the previous set or group for easy separation.

Stapled sets will not be offset.

Staple sort mode

Collated sets of prints will be stapled and delivered to the offset tray. When saddle stitching is selected, the prints will be stapled at the centre and delivered to the saddle stitch tray. The stapling positions, orientation, paper size for stapling, and stapling capacity are shown below.

STAPLING POSITIONS	PORTRAIT ORIENTATION		LANDSCAPE ORIENTATION	
Top left corner of printouts		Available paper sizes: 8½" x 11", A4 and B5 Stapling capacity: Up to 50 sheets for any sizes		Available paper sizes: 11" x 17", 8½" x 14", 8½" x 13", 8½" x 11" R, A3, B4, A4R, and B5R Stapling capacity: Up to 50 sheets for 8½" x 11"R, A4R and B5R, and up to 25 sheets for other sizes
Centre left two positions of printouts		Same as above		Same as above
Lower left corner of printouts		Same as above		Same as above
Saddle stitch on centrefold line		Paper in the portrait direction cannot be saddle stitched.		Available paper sizes: 11" x 17", 8½" x 11"R, A3, B4, and A4R Stapling capacity: Up to 10 sheets for any sizes

● **Saddle stitch function**

The saddle stitch finisher can automatically place two staples for centreline binding of prints or copies and fold them along the centreline.

<Example>

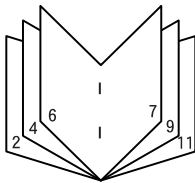

● **Hole punching (Punch module is installed)**

If the saddle stitch finisher is equipped with a hole punch module, printed paper can be hole punched and delivered to the offset tray. Saddle stitching and hole punching cannot be selected at the same time.

<Example>

Original 1 Punch positions

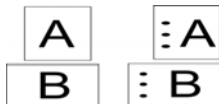

Original 2 Punch positions

● **Selecting hole punching**

Open the “Main” tab and check “Punch” under the “Finishing” heading.

The settings screens above will appear only if the devices have been set properly in the printer driver configuration.

The combination of paper selection and other functions may not always be compatible. For instance, if heavy paper, envelopes, label stock, etc. are selected, it will not be possible to select duplex, offset tray, saddle stitch, etc. For details, see printer driver help.

● **Using the saddle stitch functions**

Selecting staple or saddle stitch from the printer driver.



1. Select “Properties” on the printer driver setting screen and open the “Main” tab.
2. For normal edge or corner stapling, select “Left”, “Right” or “Top” under Binding Edge and “1 Staple” or “2 Staples” under “Staple”.
3. For saddle stitch selection, check the radio button of “Pamphlet Style” under the Document Style heading, then select “Tiled Pamphlet” or “2-Up pamphlet”.
4. Then select “2 Staples” in the “Staple” drop down under the “Finishing” heading.

The settings screens to the right will appear only if the devices have been set properly in the printer driver configuration. This example screen is for a Windows 98 PCL printer driver.

The combination of paper selection and other functions may not be compatible. For instance, if heavy paper, envelopes, label stock, etc. are selected, it will not be possible to select duplex, offset tray, saddle stitch, etc. For details, see printer driver help.

STAPLE CARTRIDGE REPLACEMENT AND STAPLE JAM REMOVAL

When the staple cartridge becomes empty or staples become jammed, a message will appear in the message display of the operation panel.

Follow the procedure below to replace the staple cartridge or remove jammed staples.

1. Open the front cover.

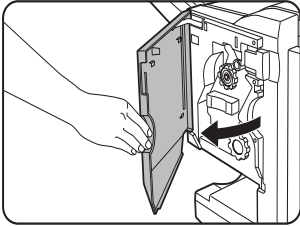

2. Pull out the stapler section.

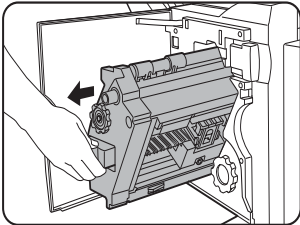

3. Turn roller rotating knob A in the direction of the arrow to move the staple unit to the front. Turn the roller rotating knob until the triangle mark is aligned with the index.

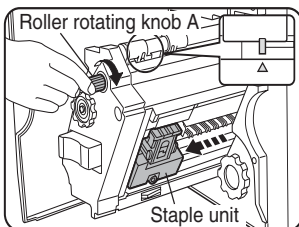

4. Remove the empty staple box.

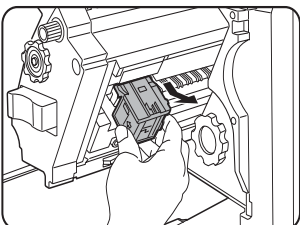

5. Remove the empty staple cartridge.

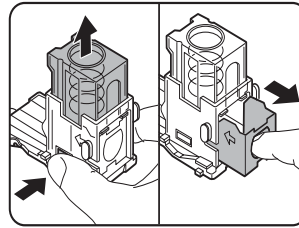

Press the lock button to unlock the staple box cover and remove the staple cartridge. If staples remain, the staple cartridge cannot be removed.

6. Insert a new staple cartridge into the staple box.

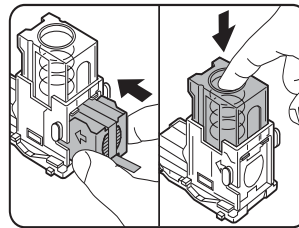

After inserting the staple cartridge, press down on the staple box cover to lock the cartridge in place. When reinstalling the staple box, push it in until it clicks into place. Do not remove the tape from the cartridge before inserting the staple cartridge into the box.

7. Remove the tape from the staple cartridge by pulling it straight.

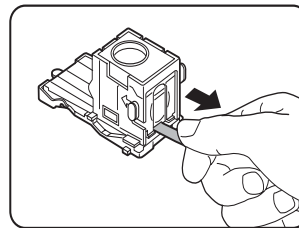

8. Insert the staple box. When reinstalling the staple box, push it in until it clicks into place.

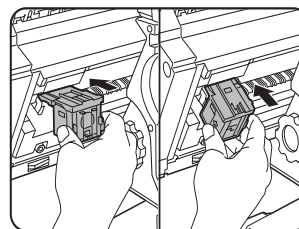

9. Push the stapler section back into the finisher. Close the front cover.

Make a test print in staple sort mode to ensure that stapling is performed properly

STAPLE JAM REMOVAL

1. Unlatch the saddle stitch finisher and slide it away from the printer.

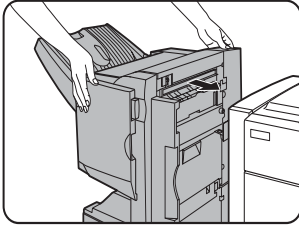

2. Open the front cover.

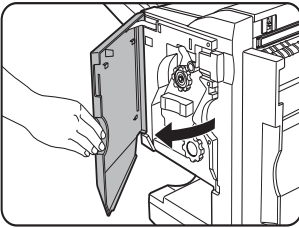

3. Turn roller rotating knob C as shown in the illustration until the blue indication is seen.

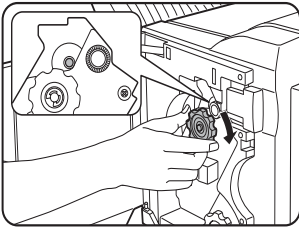

4. Remove the paper from the stapler compiler.

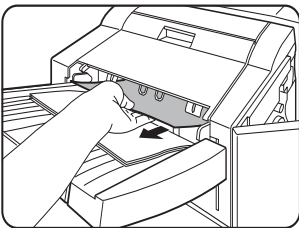

5. If saddle stitch was selected, open the saddle stitch section cover.

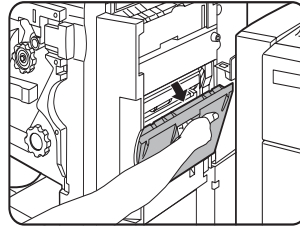

6. Remove the misfed paper. Be careful not to tear the misfed paper during removal.

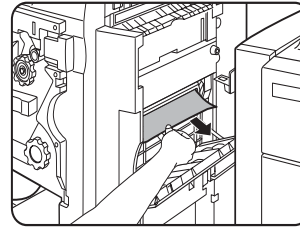

7. Close the saddle stitch section cover.

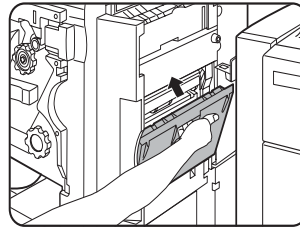

8. Open the front cover and pull out the stapler unit.

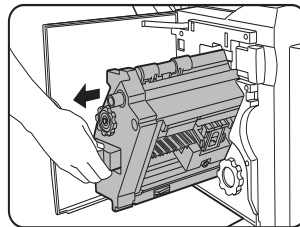

9. Turn roller rotating knob A in the direction of the arrow to move the staple unit to the front. Turn the roller rotating knob until the triangle mark is aligned with the index.

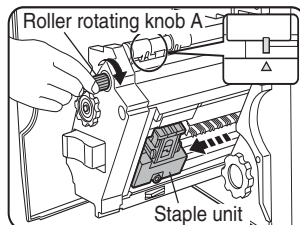

10. Remove the staple box.

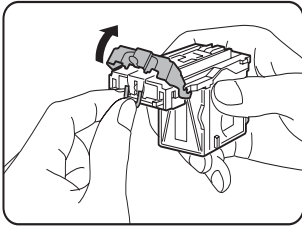

11. Raise the lever at the end of the staple box. Remove the top staple if it is bent. If bent staples remain, a staple jam will occur again.

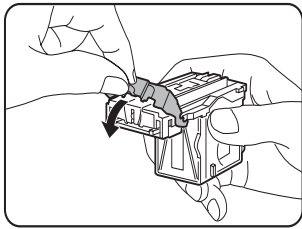

12. Return the lever to its original position.

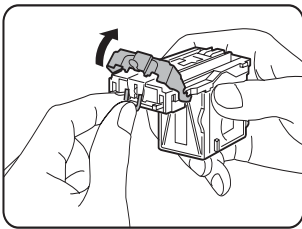

13. Reinstall the staple box. Push the staple box in until it clicks into place.

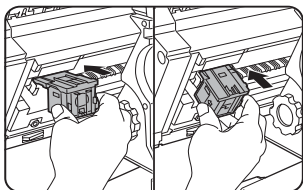

14. Push the stapler section back into the finisher.

15. Close the front cover.

16. Push the saddle stitch finisher back against the printer.

Make a test print in the staple sort mode to ensure that stapling is performed properly.

DISPOSAL OF HOLE PUNCH SCRAP

1. Unlatch the saddle stitch finisher and slide it away from the printer.

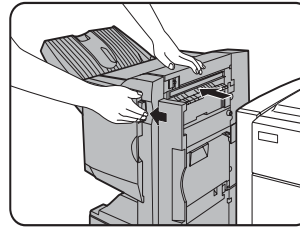

2. Pull out the punch scrap collecting container and empty it.

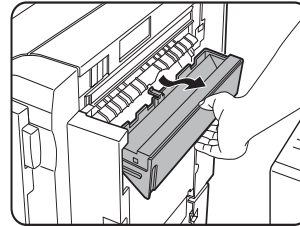

3. Return the punch scrap collecting container to its original position.

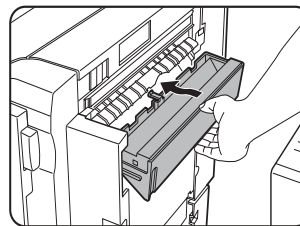

4. Push the saddle stitch finisher back against the printer.

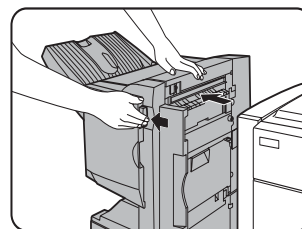

MISFEED IN THE SADDLE STITCH FINISHER

When a misfeed occurs in the saddle stitch finisher, remove the misfed paper following the procedure below.

1. Unlatch the saddle stitch finisher and slide it away from the printer.

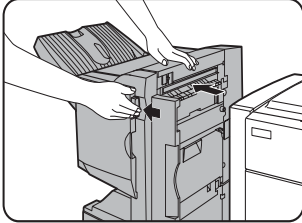

2. Remove the misfed paper from the main unit. After removing the misfed paper, open and close the duplex module to reset the jam indicator..

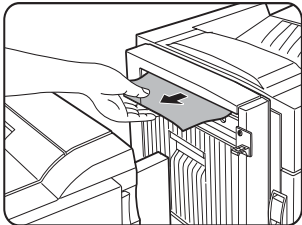

3. If misfed paper is not found in step 1, open the top cover.

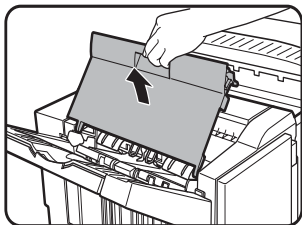

4. While pulling and turning roller rotating knob B, remove the misfed paper. If the misfed paper is released by turning roller rotating knob B, remove it taking care not to tear the paper.

5. Close the front cover.

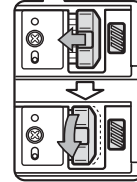
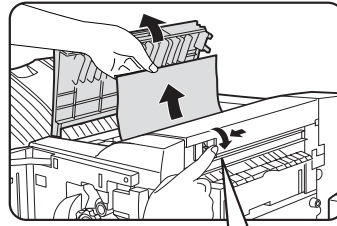
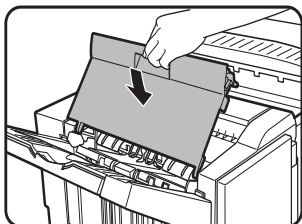

6. If saddle stitch was selected, open the front cover.

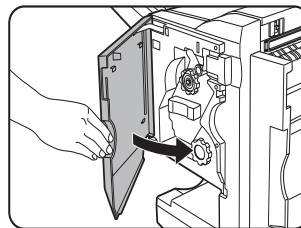

7. Remove the misfed paper from the stapler compiler. Be careful not to tear the misfed paper during removal.

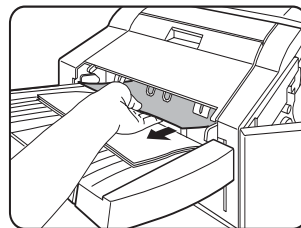

8. Open the saddle stitch section cover.

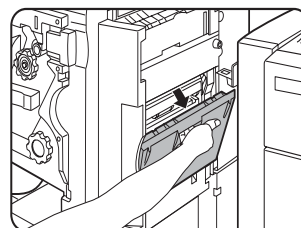

9. Remove the misfed paper. Be careful not to tear the misfed paper during removal.

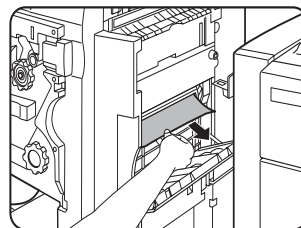

10. Turn roller rotating knob in the direction of the arrow.

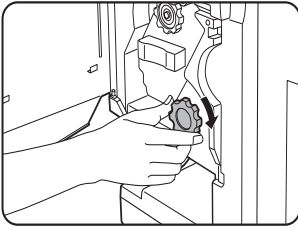

11. Remove any misfed paper from the saddle stitch tray. Be careful not to tear the misfed paper during removal.

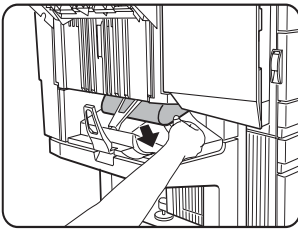

12. Close the saddle stitch section cover.

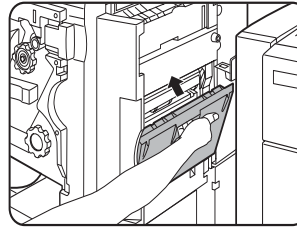

13. Close the front cover.

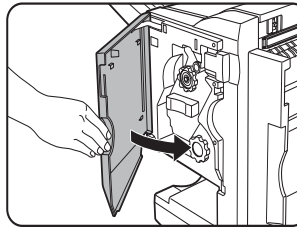

14. Push the saddle stitch finisher back against the printer.

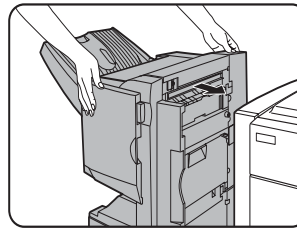

TROUBLESHOOTING (SADDLE STITCH FINISHER PROBLEMS)

Check the list below before calling for service.

PROBLEM	CHECK	SOLUTION OR CAUSE
Stapling position is not correct (including saddle stitch).	Stapling position not set properly?	Check the stapling position setting.
The saddle stitch finisher does not operate.	Are any saddle stitch finisher covers open?	Close all covers.
	Message indicating need to remove paper from the stapler compiler displayed?	Remove all remaining paper from the stapler compiler.
Stapling cannot be performed (including saddle stitch).	Message requesting check for the staple unit displayed?	Remove jammed staples.
	Message requesting adding staples displayed?	Replace the staple cartridge Check that a staple cartridge has been installed.
	Different size paper included?	Stapling cannot be performed on to different size paper.
Stapled sets are not stacked correctly or some sheets in a set are not stapled.	Paper heavily curled?	Paper may be curled heavily depending on the paper type and quality. Remove paper from the paper tray or the bypass tray, turn it upside down, and load it again.
Cannot be punched.*	Message requesting check for punch module displayed?	Dispose of punch scraps.
* When a hole punch module is installed		







STAPLING POSITION QUICK REFERENCE GUIDE FOR DUPLEX OUTPUT

The orientation of the original data and binding position selection are all interrelated. The table below shows these relationships.

		Orientation of original or original data			Output result	
		Page 1	Page 2	Page 1 & Page 2 Duplexed		
Portrait orientation printing	Left binding				One-position stapling 	Two-position stapling
						Two-position stapling along the shorter edge cannot be made.
	Top binding				One-position stapling 	Two-position stapling Top binding with two-position stapling cannot be made.
	Right binding				One-position stapling 	Two-position stapling
						Two-position stapling along the shorter edge cannot be made.
Landscape orientation printing	Left binding				One-position stapling 	Left binding with two-position stapling cannot be made.
	Top binding				One-position stapling 	Two-position stapling
						Two-position stapling along the shorter edge cannot be made.
	Right binding				One-position stapling 	Right binding with two-position stapling cannot be made.

RELATIONSHIP BETWEEN PRINT IMAGE AND SADDLE STITCH

The orientation of the data and binding position selection are all interrelated. The table below shows these relationships.

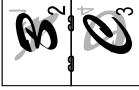
		Orientation of original or original data			Output result
Portrait orientation printing	Left binding	Page 1 	Page 2 	Page 1 & Page 2 Duplexed 	
	Right binding	Same as above			
Landscape orientation printing	Left binding	Page 1 	Page 2 	Page 1 & Page 2 Duplexed 	
	Right binding	Same as above			

- Transparency film, labels, envelopes and postcards cannot be stapled.
- If mixed paper sizes are selected for stapling jobs, stapling will be automatically cancelled.

PRINTER SPECIFICATIONS

Type	Desktop
Print system	Electrophotographic system
Exposure system	Semiconductor laser diode system
Developer system	Magnetic brush development
Paper feed system	Paper trays
Fusing system	Heat roller
CPU	64 bit RISC, 200 MHz
Memory capacity (standard)	32MB
DIMM slots for additional memory	One (64 MB to 256 MB memory can be mounted).
Page description language	PCL6, PCL5e, PS3
Resident fonts	Outline: 46 (including Line printer font) PostScript: 136
Parallel interface	IEEE-1284 compatible parallel interface (P1284B connector)
Network interface	10 Base T/100 Base TX
Warm up time	Approx. 95 seconds
Continuous print speed (A4 or 8½" x 11" paper)	45 cpm/ppm (A4 size, 8½" x 11")
Resolution	600 dpi, 1200 dpi equivalent with smoothing technology
Print colour	Black
Printing orientation	Portrait/landscape
Power supply	Rated local AC voltage ±10%, 50/60 Hz (For power supply requirements, see the name plate of the main unit.)
Power consumption	Max. 1.53 kW
Operating environments	Temperature: 15°C to 30°C (59°F to 86°F) Humidity: 20 to 80 per cent

Acoustic Noise Emission (measurement according to ISO7779)

		PRINTING MODE	STANDBY MODE
Sound power level L _{WA}		6.7 B	4.8 B
Sound pressure level L _{pA}	Bystander positions	53 dB(A)	33 dB(A)

Emission Concentration (measurement according to RAL UZ62)

Ozone	0.02 mg/m ³ or less
Dust	0.075 mg/m ³ or less
Styrene	0.07 mg/m ³ or less

428 mm x 593 mm x 567 mm x 654 mm ,
(16⁵⁵/₆₄" x 23²³/₆₄" x 22²¹/₆₄" x 25³/₄")

Weight: Approx. 50kg (111lb)
(including a multi-purpose drawer)

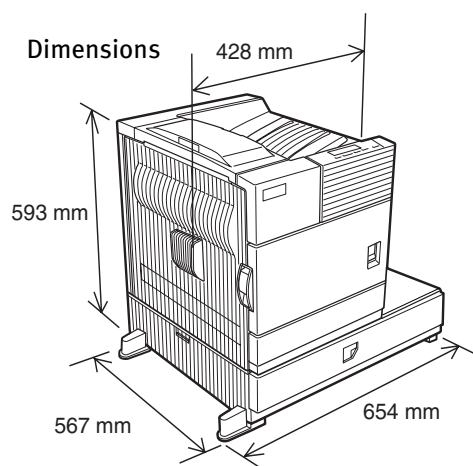

LIST OF PRINCIPAL PRINTER DRIVER FUNCTIONS

	Driver selections	PCL5e/PCL6	PS	PPD (Windows)	PPD (Macintosh)
General	Copies	1-999	1-999	1-999	1-999
	Orientation	Yes	Yes	Yes	Yes
	Duplex print	Yes	Yes	Yes	Yes
	Saddle stitch	Yes	Yes	N/A	N/A
	Binding edge	Left/top/right	Left/top/right	Long/short	Long/short
	N-up	2/4/6/8	2/4/6/8	2/4 ^{2 3}	2/4/6/9/16
	N-up direction	Fixed	Fixed	Fixed	Selectable
	N-up border line	Yes	Yes	Yes (always)	Yes
Paper	Paper size	Yes	Yes	Yes	Yes
	Custom paper size	1 size	1 size	3 sizes ^{2 4}	N/A
	Source selection	Yes	Yes	Yes	Yes
	Different first page	Yes	Yes	N/A	Yes
	Transparency inserts	Yes	Yes	N/A	Yes
Paper output	Output tray selection	Yes	Yes	Yes	Yes
	Mail bin	Yes	Yes	Yes	Yes
	Staple	Yes	Yes	Yes	Yes
	Offset	Yes	Yes	Yes	Yes
	Punch	Yes	Yes	Yes	Yes
Graphic	Resolution	600/300 dpi	600 dpi	600 dpi	600 dpi
	Halftone	N/A	Yes	Yes	N/A
	Graphic mode	Yes	N/A	N/A	N/A
	Smoothing	Yes	Yes	Yes	Yes
	Toner save	Yes	Yes	Yes	Yes
	Photo enhancement	Yes ⁷	Yes	N/A	N/A
	Negative image	N/A	Yes	Yes	Yes
	Mirror image	N/A	Horizontal/vertical	Horizontal	Horizontal/vertical
	Zoom	N/A	N/A	Yes	Yes
Fit to page	Yes	Yes	N/A	N/A	
Font	Resident font	46 fonts	136 fonts	136 font ⁵	35 fonts
	Download font	Bitmap TrueType, Graphic	Bitmap Type1 TrueType	Bitmap Type1 TrueType	N/A
Others	Watermark ⁷	Yes	Yes	Yes	Yes
	Overlay	Yes	Yes	N/A	N/A
	Job retention ¹	Yes	Yes	N/A	Yes

¹ In the models without a hard disk drive, an optional hard disk drive must be installed .

² Not supported in the Windows NT 4.0 environment.

³ 2/4/6/9/16 is supported in the Windows 2000 environment.

⁴ Only one size is supported in the Windows 2000 environment.

⁵ Only 35 fonts are supported in the Windows NT 4.0 environment.

⁶ This function is limited for PPD.

⁷ PCL6 only

LIST OF COMBINATION OF PERIPHERAL DEVICES

The table below shows the possible system configurations.

Some devices require the installation of other units (B) to be functional and some cannot be installed together (A).

	B														
	Multi-purpose drawer	Stand/3 x 500 sheet paper drawer	Stand/MPD and 2000 sheet paper drawer	Duplex module/bypass tray	Duplex module	Saddle stitch finisher	Finisher	Mail-bin stacker	Exit tray	Upper exit tray extension	Punch unit	Multi-function controller board	Print server card	Power supply unit	Hard disk drive
Related to paper feed unit															
Multi-purpose drawer	—	X	X			X					X				
Stand/3 x 500 sheet paper drawer	X	—	X											0	
Stand/MPD and 2000 sheet paper drawer	X	X	—											0	
Duplex module/bypass tray ²		O ¹		—		X					X			0	
Duplex module ²		O ¹			—									0	
Output units															
Saddle stitch finisher	X		O ¹	X	0	—	X		X					0	
Finisher		O ¹				X	—	X			X			0	
Mail-bin stacker		O ¹					X	—						0	
Exit tray					O ¹	X			—		X				
Upper exit tray extension							X	X		—					
Punch unit	X		O ¹	X	0	0	X		X		—			0	
Related to extension of functions and others															
Power supply unit														—	
Hard disk drive															—
Multi-function controller board			O ¹								—				
Print server card												—			

0 = (A) and (B) must be installed together.

O¹ = (A) requires installation of one of the (B) units.

X = Cannot be installed together.

² If the multi-purpose drawer is installed, the power supply unit is not needed.

NOTICE PAGE PRINTING

A notice page will be printed when the current print job cannot be done due to a system limitation and an explanation of the limitation is too lengthy to be shown in the message display. A notice page will describe the limitation and other possibilities to run the job.

A notice page will be printed in the following cases:

- › When sufficient memory is not available to store the print data. This may happen even if the amount of data for the job is not large when the memory becomes full with data of other jobs.
- › When a print job is sent to the printer and the number of print hold jobs has reached the maximum of 100 jobs.
- › When different paper sizes have been selected for printing within a print job and one or more of the sizes cannot be delivered to the selected exit tray or to the stapler compiler. In these cases printed paper will be delivered partly to the specified destination (tray or compiler) and partly to another exit tray.
- › When a function has been selected for printing but has been disabled by a key operator program. (Duplex module is disabled, stapler is disabled, punch is disabled, specified exit tray is disabled, etc.)
- › An invalid account number is entered when the auditing mode has been set.

Disabling of notice page printing

Notice page printing can be disabled using a key operator program.

PRINT AREA

The print area of this product is shown below.

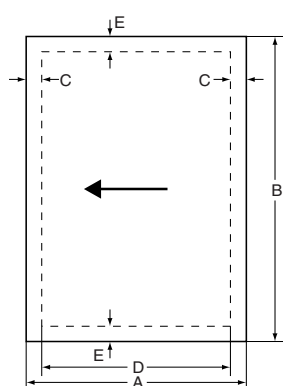

Paper size
 Printable area

- If a printer driver for Windows or Macintosh is used for printing, the printable area will be smaller. The actual printable area depends on the printer driver to be used.

PAPER SIZE	Dimension in mm				
	A	B	C	D	E
A3	297	420	4	289	4
B4	257	364	4	242	4
A4	210	297	4	202	4
B5	182	257	4	168	4
A5	148	210	4	140	4
Japanese postcard	100	148	4	92	4
Tabloid	279	432	4	271	4
Legal	216	356	4	208	4
Foolscap	216	330	4	208	4
Letter	216	279	4	208	4
Executive	184	267	4	183	4
Invoice	140	216	4	132	4
Com-10 (envelope)	105	241	4	97	4
C5 (envelope)	162	229	4	154	4
Monarch (envelope)	98	191	4	90	4
DL (envelope)	110	220	4	102	4
ISO B5 (envelope)	176	250	4	168	4

PCL SYMBOL SET

No.	SYMBOL SET
1	Roman-8
2	ISO 8859-1 Latin 1
3	PC-8
4	PC-8 Danish/Norwegian
5	PC-850
6	ISO 6 ASCII
7	Legal
8	ISO 21 German
9	ISO 17 Spanish
10	ISO 69 French
11	ISO 15 Italian
12	ISO 60 Norwegian v1
13	ISO 4 United Kingdom
14	ISO 11 Swedish
15	PC1004 (OS/2)
16	DeskTop
17	PS Text
18	Microsoft Publishing

No.	SYMBOL SET
19	Math-8
20	PS Math
21	Pi Font
22	ISO 8859-2 Latin 2
23	ISO 8859-9 Latin5
24	ISO 8859-10 Latin 6
25	PC-852
26	PC-775
27	PC Turkish
28	MC Text
29	Windows 3.1 Latin 1
30	Windows 3.1 Latin 2
31	Windows 3.1 Latin 5
32	Windows Baltic (not 3.1)
33	Windows 3.0 Latin 1
34	Symbol
35	Wingdings
<ul style="list-style-type: none"> • These symbol sets are trademarks or registered trademarks of their respective owners. 	

Oki System Companies

Oki Systems (UK) Limited
550 Dundee Road
Slough Trading Estate
Slough, Berkshire SL1 4LE
Tel: 44 (0) 1753 819819
Fax: 44 (0) 1753 819899
www.oki.co.uk

Oki Systèmes (France) S.A.
44-50 Av. du Général de Gaulle
94240 L'Hay les Roses
Tel: 01 46 15 80 00
Fax: 01 46 15 80 60
www.oki.fr

Oki Systems (Deutschland) GmbH
Hansaallee 187
40549 Düsseldorf
Tel: +49 (0) 211 52 66-0
Fax: +49 (0) 211 59 33-45
www.oki.de

Oki Systems (Holland) b.v.
Postbus 690
2130 AR Hoofddorp
Fax: 020 - 6531301
Helpdesk: 900-2025285
www.oki.nl

OKI Systems (Italia) S.p.A.
c.c. "Il Girasole" - Lotto 3.05/B
20084 Lacchiarella (MI)
Tel. 02900261
Fax: 029007549
www.oki.it

Oki Systems (Iberica), S.A.
Paseo de la Habana, 176
28036 - Madrid
Tel: 91-3431620
Fax: 91-3431624
www.oki.es

Russia
101000, Russia, Moscow
Bolshoy Zlatoustinsky per.
d. 1 str. 6
info@oki.ru
www.oki.ru

Okidata
Oki Data Americas, Inc.,
2000 Bishops Gate Blvd.,
Mt. Laurel,
NJ 08054-4620
Tel: 856 235-2600
FAX: 856 222-5320
www.okidata.com

Oki Data Corporation
4-11-22 Shibaura
Minato-ku
Tokyo 108
Japan