

Pro1040/Pro1050

Setup Guide

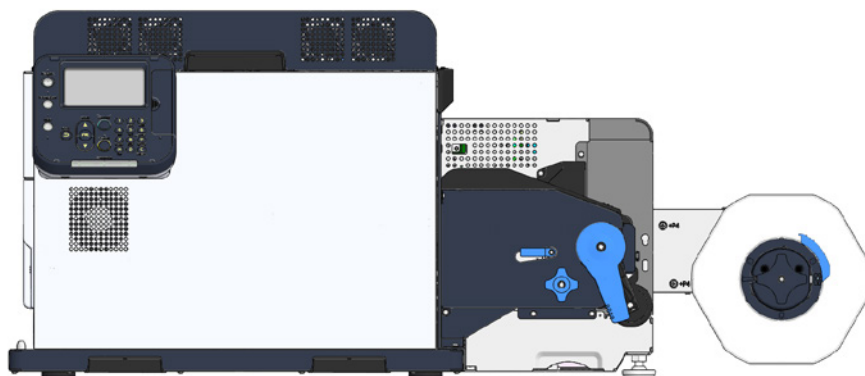

● Manual Configuration

The following manuals are included with the product.

- Residual Risk

This manual describes the map of residual risks that require protective measures by users.

- Setup Guide (This Manual)

This manual describes how to connect the printer to a computer and set it up following installation.

- User's Guide

This manual describes details about product functions and operations.

- Maintenance Guide

This manual describes how to replace consumables, and how to clean and maintain the product.

The latest versions of the manuals can be downloaded at the website.

<https://www.oki.com/printing/>

● About the Included Software DVD-ROM

Placing the Software DVD-ROM that comes with the printer into the computer's DVD-ROM drive causes the menu screen shown below to appear on the display.



- The examples here show Windows screens.

Select to add printer drivers and select the driver you want.

Select to install the standard printer driver.

Shows the selected printer and computer connection type.

Refer to this PDF manual to find out about useful printer functions and how to configure settings. *1

The screenshot shows the 'OKI Setup - Install Optional Software' window. At the top, it displays 'Device Name: Pro1050, Interface: USB connection'. Below this is a red header '1. Install Optional Software' and a progress bar showing '1. Install Optional Software > 2. Device Settings > 3. Complete'. The main area contains two buttons: 'Install Optional Software' (with a CD icon) and 'Custom Install'. At the bottom, there are three buttons: 'Interface Selection', 'Device Selection', and 'Next'. A 'Main Menu' box on the right says 'Install the driver and software to the PC.' Callouts with lines pointing to the buttons provide instructions: 'Install Optional Software' is for adding drivers; 'Custom Install' is for installing the standard driver; 'Interface Selection' is for specifying the connection method; 'Device Selection' is for specifying the printer model; and 'Next' is for going to the next screen. A 'User's Manual' button in the top right is also highlighted with a callout.

*1: Adobe Reader/Adobe Acrobat Reader is required to view the PDF manual.

● Reading the Manual

Symbols



Note

- These are cautions and restrictions for the correct operation of the device. Make sure to read to avoid misoperation.



Memo

- These are references and information that are useful when using the device. We recommend reading them.



Reference

- These are the reference pages. Read to learn detailed information and relevant information.

WARNING

- Mishandling due to ignoring this display may cause death or serious injury.

CAUTION

- Mishandling due to ignoring this display may cause personal injury.

Keys, Buttons, and Symbols

This chapter describes the following keys, buttons, and symbols.

Notation	Description
< > button/key	<ul style="list-style-type: none"> • Indicates hardware buttons and the numeric keypad on the control panel. E.g.: <div style="display: flex; justify-content: space-around; align-items: center;"> <div style="text-align: center;"> → <OK> button </div> <div style="text-align: center;"> → <BACK> button </div> </div> <div style="display: flex; justify-content: space-around; align-items: center; margin-top: 10px;"> <div style="text-align: center;"> → <Fn> key </div> <div style="text-align: center;"> → <CLEAR> key </div> </div> <ul style="list-style-type: none"> • Indicates your PC keyboard.
[]	<ul style="list-style-type: none"> • Indicates menu names on the display screen. • Indicates menu, window, and dialog names on the computer.
" "	<ul style="list-style-type: none"> • Indicates messages and input text on the display screen. • Indicates file names and screen names on the computer. • Indicates reference titles.
>	Indicates how to get to the item you want in the menu of this printer or the computer.

Illustrations

Unless otherwise specified, the printer illustrations used herein show the printer with the unwinder mounted.

Illustrations may differ from the actual product.

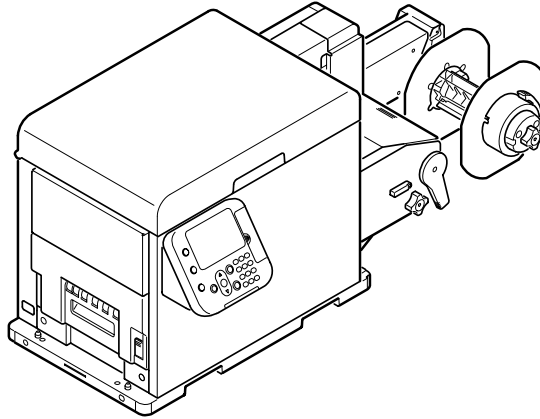

Screens

The images of the control panel and PC used herein are examples. The images may differ from actual products and screens.

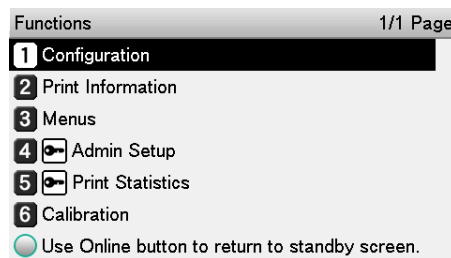

Inscriptions

The following inscriptions are used in this manual.

- Microsoft® Windows® 10 64-bit Edition operating system → Windows 10 (64-bit Edition)
- Microsoft® Windows® 10 operating system → Windows 10

Unless otherwise specified, the examples in the manuals included with the printer show operation using Windows 10 and the Pro1050 printer.

Depending on the OS, model, and version you are using, descriptions in this manual may differ from what you actually encounter.

● For Your Safety



















Read the provided manuals for your safety before using the product.

Cautions Related to Safety

 **WARNING** Mishandling due to ignoring this display may cause death or serious injury.

 **CAUTION** Mishandling due to ignoring this display may cause personal injury.

General Cautions

 WARNING		
 Do not touch the safety switch inside this machine. High voltage may occur, resulting in electric shock. Also, a gear may rotate, resulting in injury.	 Do not use a highly combustible spray near this machine. Some parts inside the machine become very hot, possibly resulting in fire.	 If the cover becomes extremely hot, the machine emits smoke or odor, or you hear a strange sound, unplug the power plug from the outlet, and contact your dealer. Fire may result.
 If liquid such as water gets inside the machine, unplug the power plug from the outlet, and contact your dealer. Fire may result.	 If you drop a clip or other foreign objects into the machine, unplug the power plug from the outlet, and take the foreign objects out. Electric shock, fire, or injury may result.	 Do not perform any operation or disassembly other than instructed in manuals. Electric shock, fire, or injury may result.
 There is a risk of explosion if the battery is replaced with the wrong type of battery. The battery in the machine does not need to be replaced. Do not touch the battery.	 If the machine is dropped or the cover is damaged, unplug the power plug from the outlet, and contact your dealer. Electric shock, fire, or injury may result.	 Unplug the power plug regularly, and clean the bases of and in between the plug blades. If the power plug is left plugged into the outlet for an extended period of time, dust adheres on the bases of the plug blades, and a short may occur, possibly resulting in fire.
 Do not connect the power cord, cables, or the ground wire in any way other than instructed in manuals. Fire may result.	 Do not put a cup with liquids such as water on the machine. Doing so may cause electric shock and/or fire leading to personal injuries.	 Do not let pet urine or other liquid get inside this machine, or allow this machine to get wet. Electric shock or fire may result.
 Do not insert any object into a vent hole. Electric shock, fire, or injury may result.	 Do not throw print cartridges or waste toner boxes into a fire. The toner may ignite, resulting in burns.	 Do not vacuum spilled toner with an electric vacuum cleaner. Vacuuming spilled toner with an electric vacuum cleaner may result in ignition due to sparks from electric contacts or other reasons. If toner spills on the floor or other places, wipe the toner gently with a damp rag or other cloth while using care not to scatter the toner.
 When the machine cover is opened, do not touch the fuser unit. Burns may result.	 Operation using an UPS (uninterruptible power supply) or inverter is not guaranteed. Do not use an uninterruptible power supply or inverter. Fire may result.	

 CAUTION	
 Do not go near the paper output part when you turn the power on or when printing is in progress. Injury may result.	 Do not disassemble the print cartridge, or force it open. You may inhale the scattered toner, or the toner may land on your hands or clothes, making them dirty.

● Precautions about the Installation Environment and Location to Install the Machine

[Precautions related to installation]

⚠ WARNING

- Do not install the equipment in a location that is near open flame or may become very hot.
- Do not install the equipment in a location prone to chemical reactions (laboratory, etc.).
- Do not install the equipment in a location that is near flammable liquids, such as alcohol or paint thinner.
- Do not install the equipment in a location that is accessible by small children.
- Do not install the equipment in a location that is unstable (on a wobbly table or inclined place).
- Do not install the equipment in direct sunlight or in a very dusty or humid location.
- Do not install the equipment in an environment subject to salt air, NO_x, SO_x or corrosive gases.
- Do not install the equipment in a location that is subject to excessive vibration.
- Do not install the equipment in a location where the machine's vents are blocked. Check the positions of the vents in the following illustration.

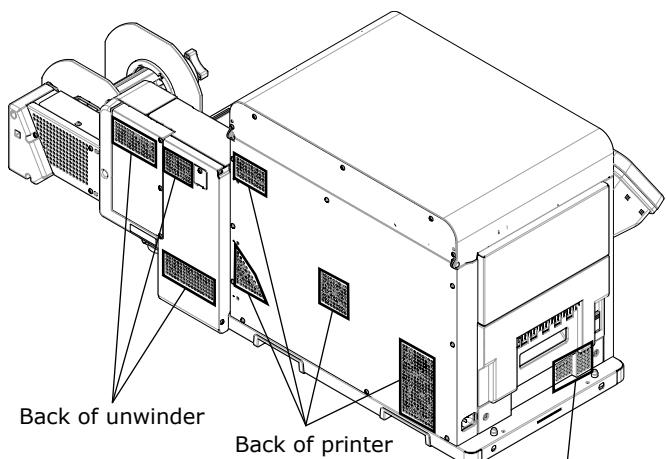
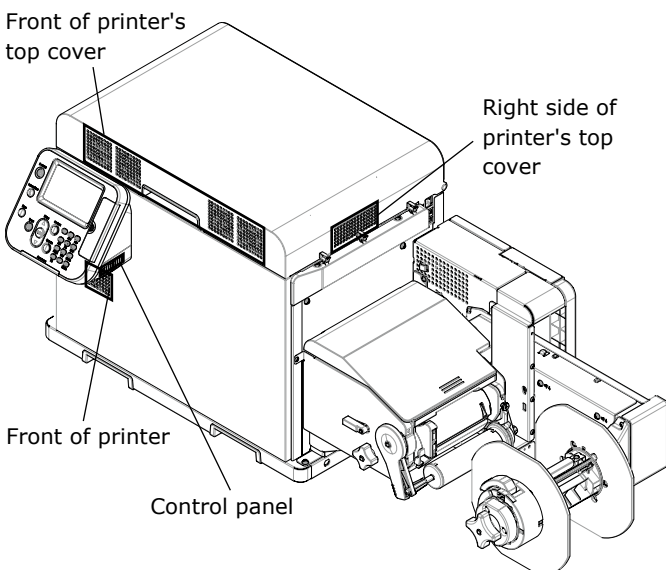

⚠ CAUTION

- Do not install the equipment on a thick-piled carpet or rug.
- Do not install the equipment in a location that is poorly ventilated or stuffy.
- Pay attention to ventilation when operating the equipment continuously for a long period in a small room.
- Install the equipment away from sources of strong magnetic or electric noise.
- Install the equipment away from monitors or televisions.
- Remember to use ventilation when printing large volumes or operating the equipment continuously for a long period.
- The machine's acoustic power level exceeds 6.3B, so we recommend that it be installed in a room separate from office work areas.

Consider the following environment conditions when you select the installation location.

[Installation Environment]

Use a location that is within the following ranges for temperature and humidity.

Temperature range:	10 to 30 °C
Humidity range:	20 to 70% RH
	(relative humidity)
Maximum wet-bulb temperature:	25 °C

Memo

- Be careful that condensation does not form.
- If you install the equipment in a location where the humidity is in a range of less than 30%, use a humidifier or anti-static mat.

[External Dimensions]

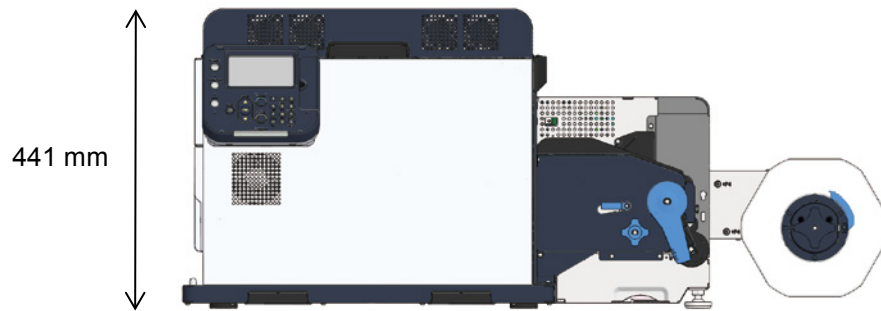
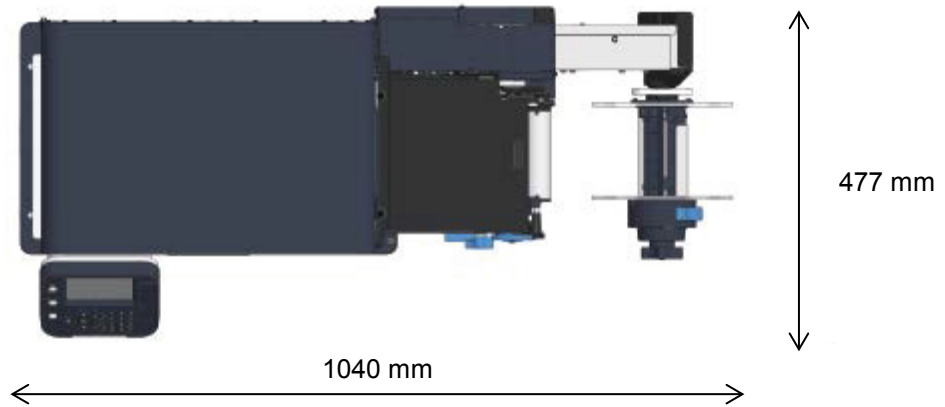

[Installation Space]

- Select an installation location that is level and can support the weight of the machine (weight of equipment is about 43 kg* for the printer and about 19 kg for the unwinder).
* Including the print cartridge and other consumables.
- Install the machine near a power socket. Also, install the equipment so the power socket is within easy reach so the power plug can be pulled out in an emergency.
- Do not place things around the machine.

To install the printer and the unwinder on a stand, the stand must be at least 1050 mm wide and 500 mm deep. If you install the printer and the unwinder on a stand that is too small, they may fall off if they are hanging over the edge of the stand.

Install the equipment according to the equipment installation space shown in the diagram.

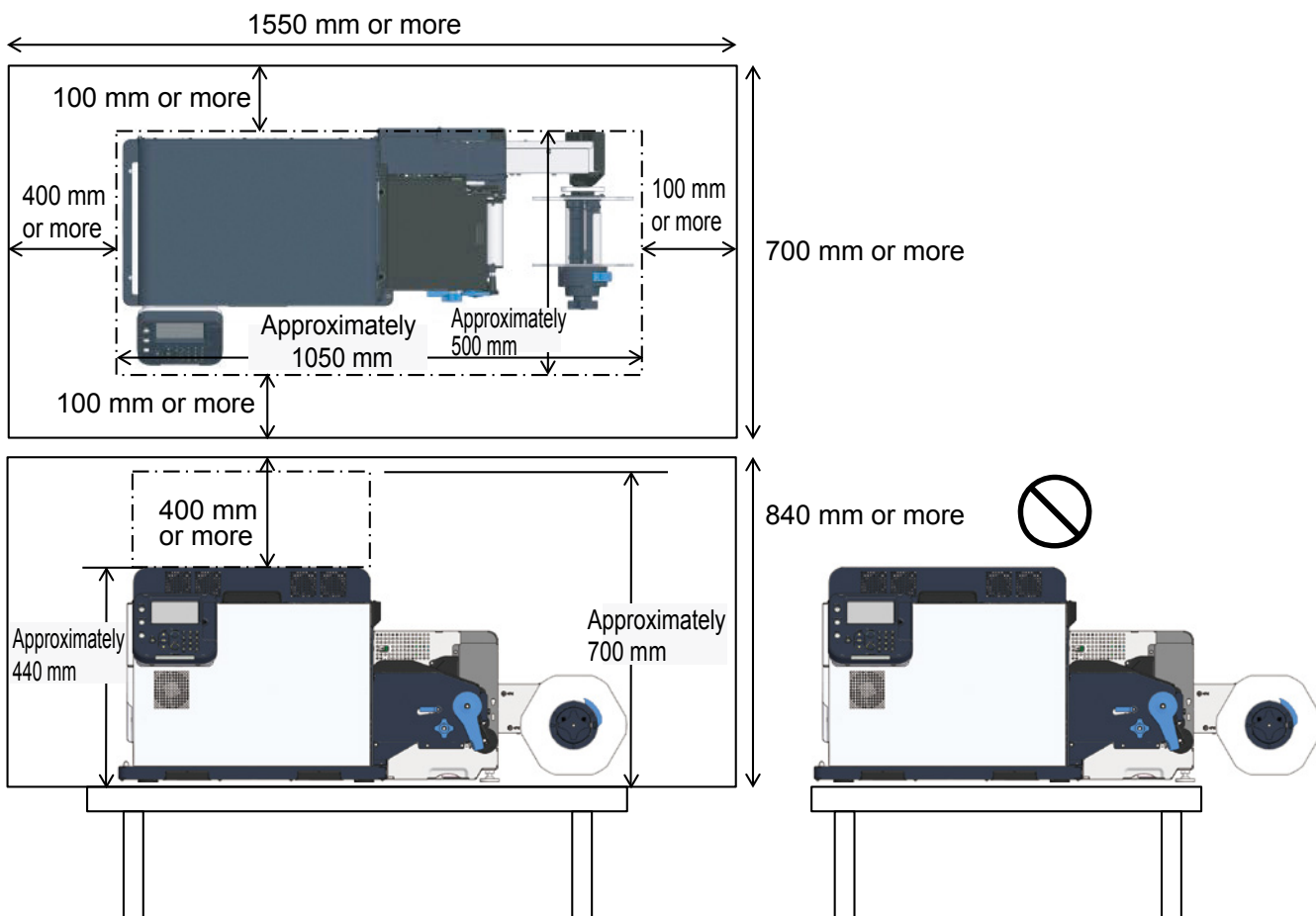

● About the Product Warranty

Every effort has been made to ensure that the information in this document is complete, accurate, and up-to-date. The manufacturer assumes no responsibility for the results of errors beyond its control. The manufacturer also cannot guarantee that changes in software and equipment made by other manufacturers and referred to in this guide will not affect the applicability of the information in it. Mention of software products manufactured by other companies does not necessarily constitute endorsement by the manufacturer.

While all reasonable efforts have been made to make this document as accurate and helpful as possible, we make no warranty of any kind, expressed or implied, as to the accuracy or completeness of the information contained herein.

All rights are reserved by Oki Electric Industry Co., Ltd. You must not copy, transfer, translate, etc. the content herein without authorization. You must obtain written permission from Oki Electric Industry Co., Ltd. before doing any of the above.

© 2018 Oki Electric Industry Co., Ltd.

OKI is a registered trademark of Oki Electric Industry Co., Ltd.

Microsoft, Windows, Windows Server are registered trademarks of Microsoft Corporation.

Other product names and brand names are registered trademarks or trademarks of their proprietors.



This product complies with the requirements of the Council Directives 2014/30/EU (EMC), 2011/65/EU(RoHS) and 2006/42/EC(MD) as amended where applicable, on the approximation of the laws of the member states relating to Electromagnetic Compatibility, Restriction on the use of certain Hazardous Substances and Machinery in electrical and electronic equipment.

The following cables were used to evaluate this product to achieve EMC directive 2014/30/EU compliance and configurations other than this may affect that compliance.

cable type	length (meters)	core	shield
Power	1.8	x	x
USB	5.0	x	✓
LAN	5.0	x	x

● Emergency First Aid

Take care with toner powder:



If you inhale it

Move to an area with fresh air and rest in a posture that allows you to breath freely.

If it gets on your skin

Wash with plenty of soap and water.

If it gets in your eyes

Very carefully wash with water for several minutes. Next, if you are wearing contact lenses and can easily remove them, then remove them. Then, continue washing.

If you drink it

If you feel bad, contact a physician.

● Environmental Information



● Pro1040/Pro1050 Features



Roll paper printing

Printing on die-cut labels and black marked roll paper is supported. Roll paper can also be cut for single sheet output.

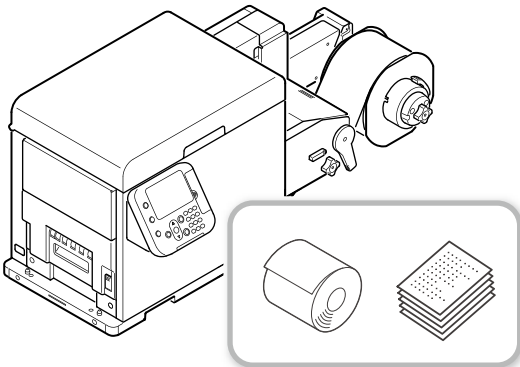

A powerful collection of color calibration functions

The printer's control panel has functions for correcting color alignment and density, in order to adjust color balance. The computer-based color management system can be used to adjust color and simulate print results or print color analysis.

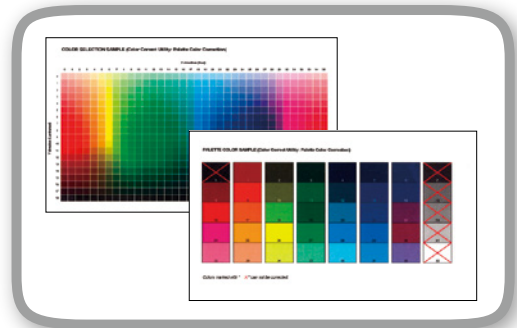

A variety of useful printer functions

When printing from a computer, you can use a variety of useful printer functions.

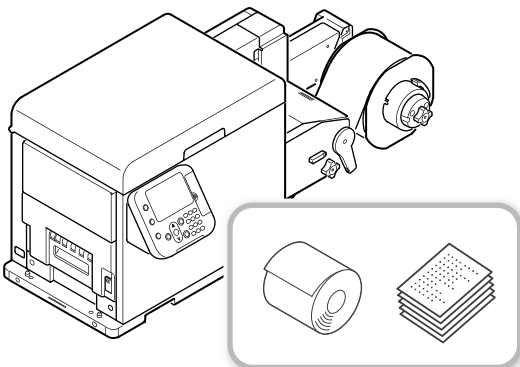

Printing from a wide range of applications

Adobe PostScript3 and PCL6 emulation come built-in, enabling support for printing from a wide range of applications.

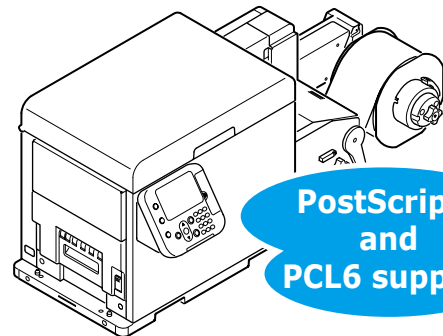

PostScript3
and
PCL6 support



The control panel shows the printer status, and displays error messages and help information.

The control panel standby screen can be used to show the "Supplies Life" or the "Unwinder Config". When an error occurs on the printer, corrective action can be taken while monitoring messages that appear on the control panel.

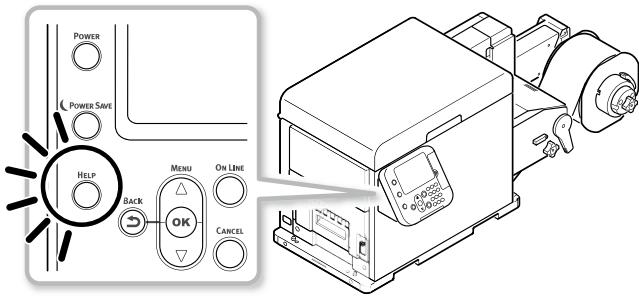

Power consumption is reduced while the printer is not in use (Power Save Mode).

When the printer is not used for a fixed amount time, it automatically enters a Power Save Mode and reduces power consumption. You can also enter the Power Save Mode manually by pressing the <POWER SAVE> button.

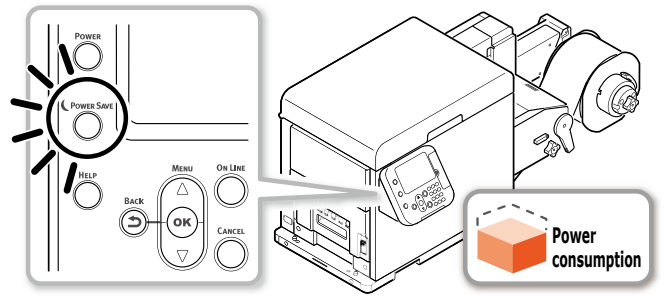

Function setting configuration on the control panel

The control panel can be used to change the paper size, and to configure the network setup and other function settings. The administrator password can also be set using the control panel.

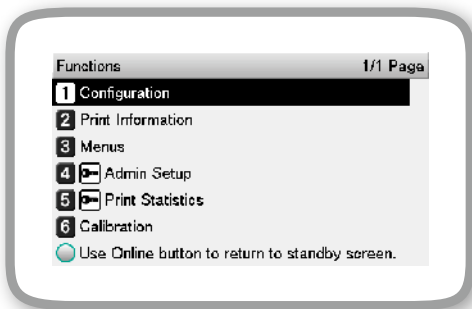

Table of Contents

Manual Configuration.....	2
About the Included Software DVD-ROM.....	3
Reading the Manual.....	4
Symbols	4
Keys, Buttons, and Symbols.....	4
Illustrations	5
Screens.....	5
Inscriptions.....	5
For Your Safety.....	6
Cautions Related to Safety	6
General Cautions.....	6
Precautions about the Installation Environment and Location to Install the Machine.....	7
About the Product Warranty	10
Emergency First Aid	11
Environmental Information.....	11
Pro1040/Pro1050 Features.....	12
Parts Nomenclature and Functions.....	16
Printer.....	16
Front/Left Side.....	16
Printer Interior.....	18
Interfaces	20
Unwinder.....	21
Control Panel	23
Using the Control Panel.....	24
Using the Numeric Keypad.....	27
Function Number List.....	28
Turning on and off the Power Supply	29
Precautions about the Electric Power	29
Power source conditions.....	29
Connecting a Power Cord	30
Turning on the Power Supply	30
Turning off the Power	31

Connecting to a PC	32
Flow for Installing the Driver on a Computer.....	32
Operating Environment.....	33
Connecting Cables	34
LAN Cable Connection.....	34
USB Cable Connection	35
Installing the Printer Driver	36
Network Connection	36
Connecting with USB	42
Dealing with Setup Problems	45

● Parts Nomenclature and Functions

Printer

Front/Left Side

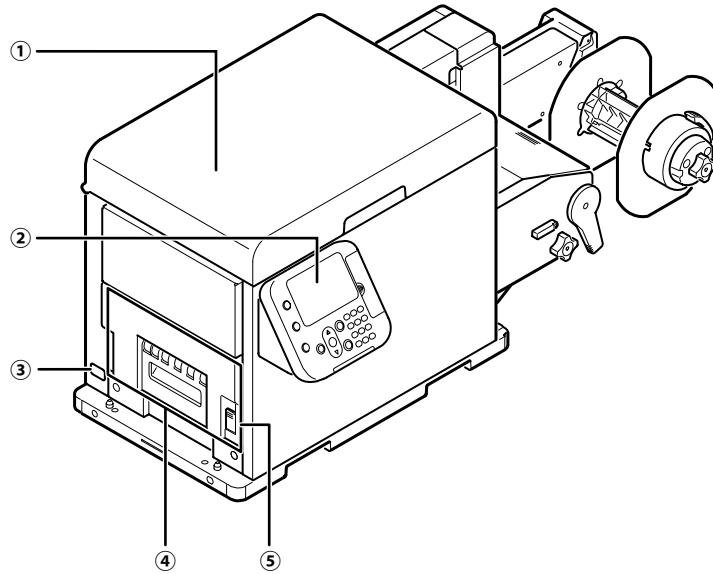

① Top Cover

Open when replacing the print cartridge, belt unit, 2nd transfer roller, or waste toner box, or when clearing a paper jam.

② Control Panel

Displays the printer status and menus, and is used when configuring function settings.

["Control Panel" \(P.23\)](#)

③ Power connector

Connect the supplied power cord here.

④ Fuser and Exit Unit

Remove when replacing the fuser and exit unit or when clearing a paper jam.

The fuser and exit unit is a consumable item.

⑤ Fuser and Exit Unit Locking Lever

Use when removing or installing the fuser and exit unit.

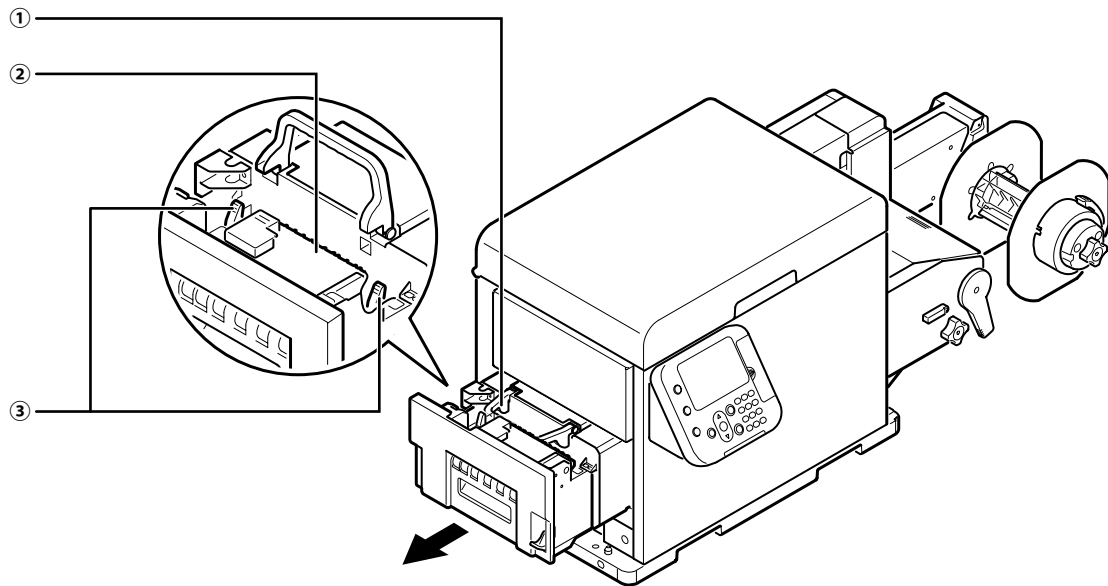

① Fuser and Exit Unit Handle
Pull upwards when removing the fuser and exit unit.

③ Release Lever
Press downwards when opening the exit feed cover.

② Exit Feed Cover
Open when clearing a paper jam.

Printer Interior

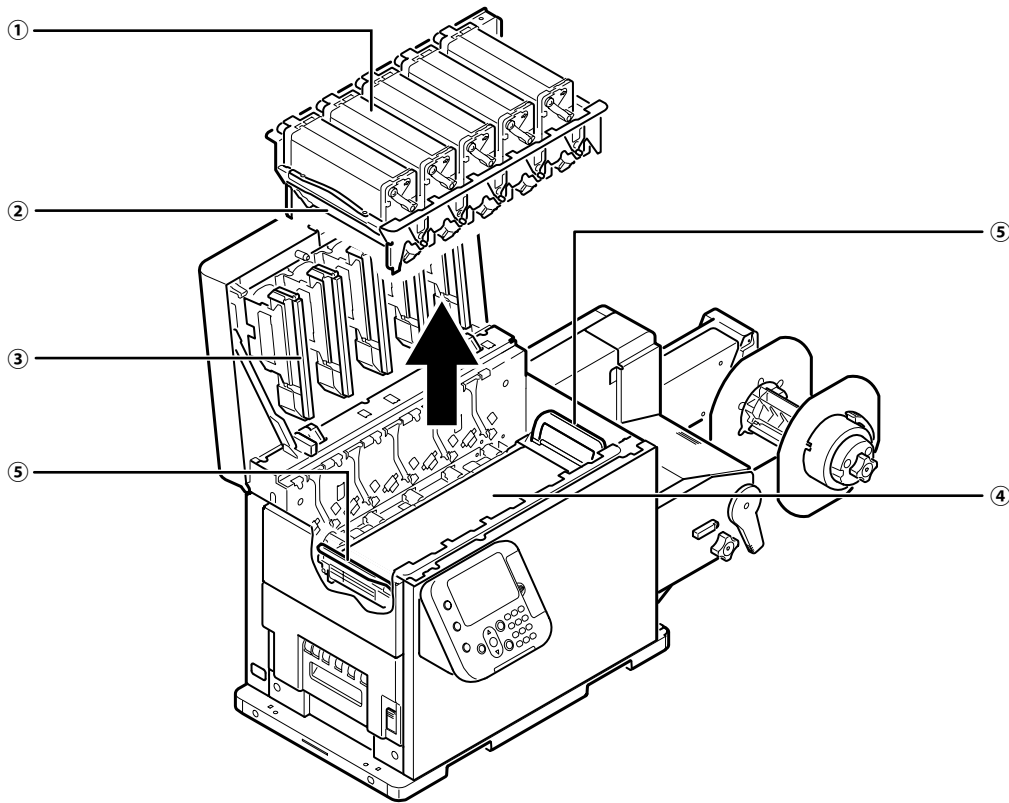

① Print Cartridge

Develop the image with toner drawn by the LED head, and transfer the toner image onto the belt unit.

The remaining life of the print cartridge is always displayed while the "Supplies Life" is specified for the standby screen of the control panel.*¹

The print cartridge is a consumable item.

② Print Cartridge Set

Remove when replacing the belt unit, 2nd transfer roller, or waste toner box, or when clearing a paper jam.

③ LED Head

Draws the image being printed onto the print cartridge.

④ Belt Unit

Transfers toner to the paper.
The belt unit is a consumable item.

⑤ Belt Unit Handle

Grasp when removing the belt unit.

*1: Refer to "[Standby Screen](#)" (P.25) regarding how to switch the standby screen of the control panel.

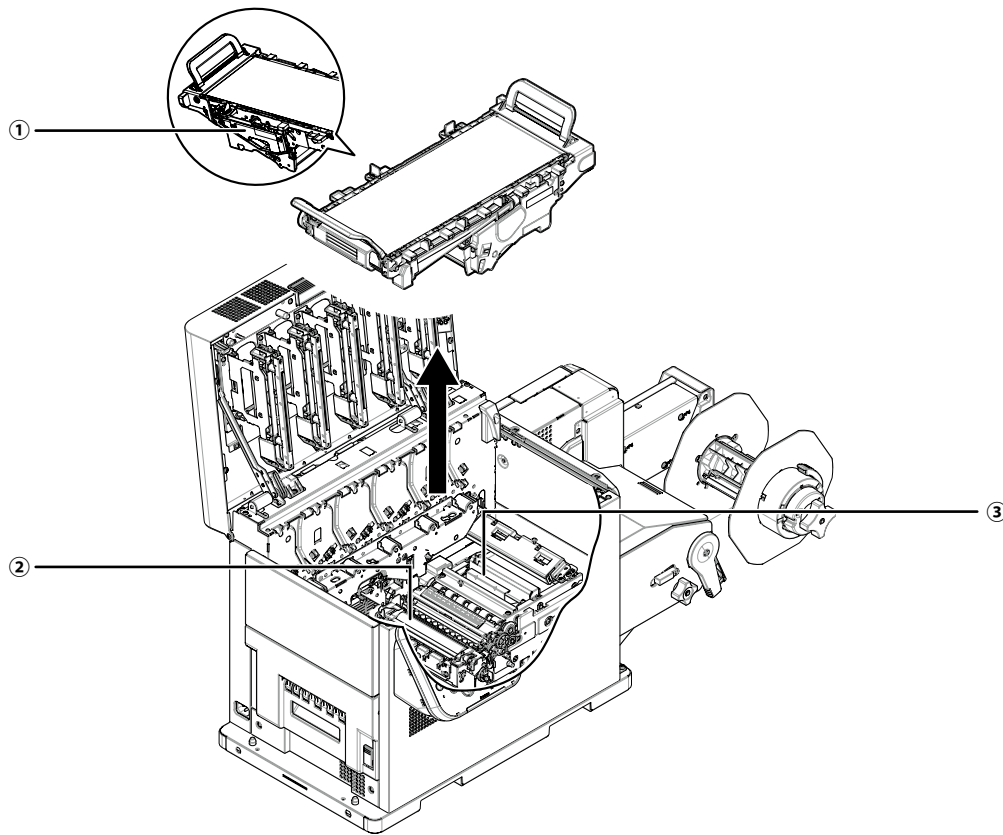

① Waste Toner Box

Stores waste toner.
 A message appears on the control panel when the box is full of waste toner.
 The waste toner box is a consumable item.

② 2nd Transfer Roller

Transfers toner to the paper.
 The 2nd transfer roller is a consumable item.
 The 2nd transfer roller is included with the belt unit.

③ Paper Guide

Remove when a paper jam occurs in the paper transport path or when cleaning the paper transfer roller.
 The Paper Guide is a periodically replaced part.

Interfaces

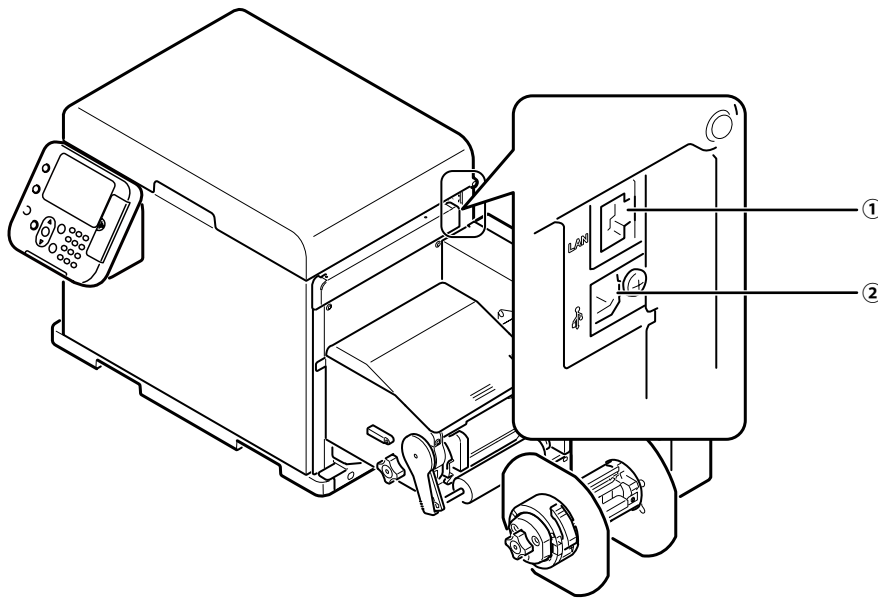

① LAN (Network) Interface Connector
For connection of a LAN cable. Use this connector when connecting the printer on a network.

② USB 2.0 Interface Connector
For connection of a USB 2.0 cable. Use this connector when using a USB cable to connect the printer directly to a computer.

Unwinder

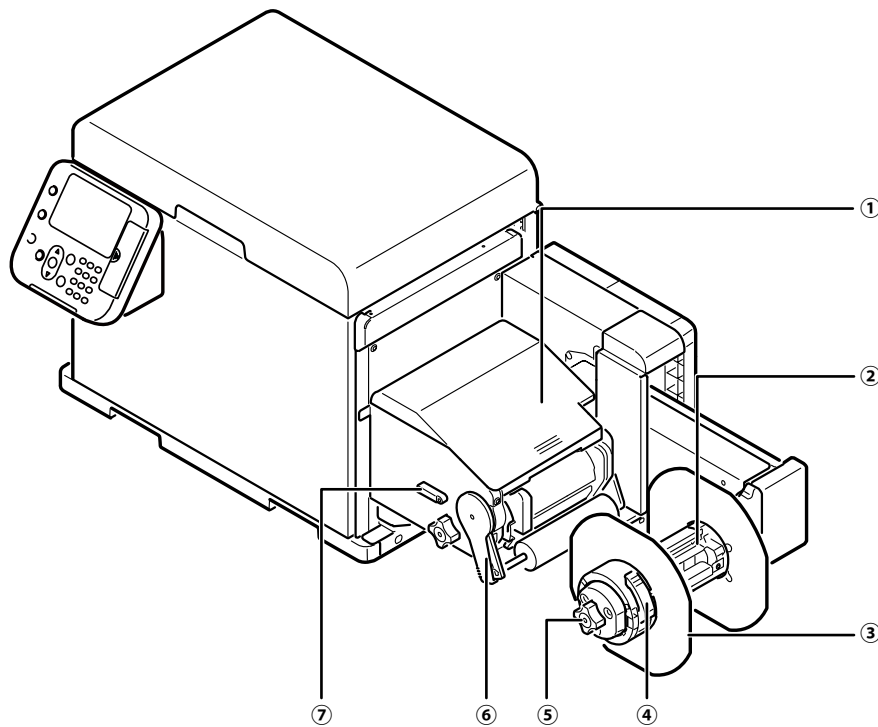

① Unwinder Cover

Open this when setting paper or clearing paper jams.

② Roll Paper Holder

Sets the paper to be printed.

③ Flange

Fixes roll paper to the roll paper holder so the roll paper set on the roll paper holder feeds straight.

④ Flange Locking Lever

Use when removing/mounting the flange.

⑤ Roll Paper Holder Knob

Use when securing the core of a roll paper that has been placed on the roll paper holder.

⑥ Tension Bar Open Lever

Keeps roll paper that has been set from sagging.

⑦ Unwinder Cover Open Lever

Lower to open the unwinder cover.

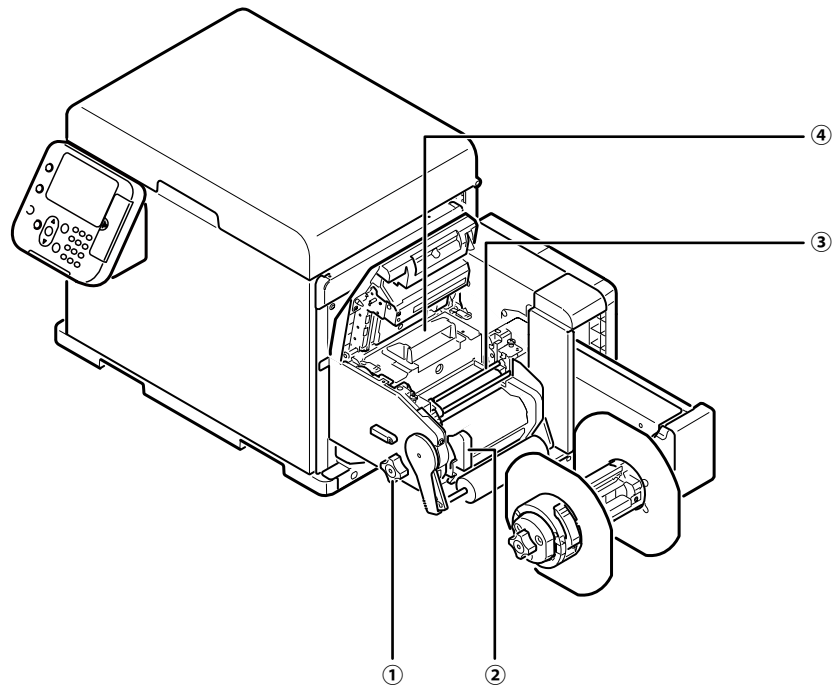

① Roll Paper Guide Adjustment Knob
Rotate the knob to adjust the roll paper guide to the width of the paper to be printed.

② Roll Paper Guide
Align the roll paper guide along the edge of paper to be printed.

③ F0 Roller Unit
The F0 roller unit is a roller for feeding roll paper.
The F0 roller unit is a periodically replaced part.

④ Cutter Unit
Cuts the roll paper to a specified length.
The cutter unit is a periodically replaced part.

Control Panel

The control panel can be used to check the current status of the printer and to access various functions available with the printer.

With this printer, print cartridges etc. can be replaced while monitoring the LCD on the control panel. If a paper jam or some other problem occurs on the printer, corrective action can be taken while monitoring messages that appear on the LCD.

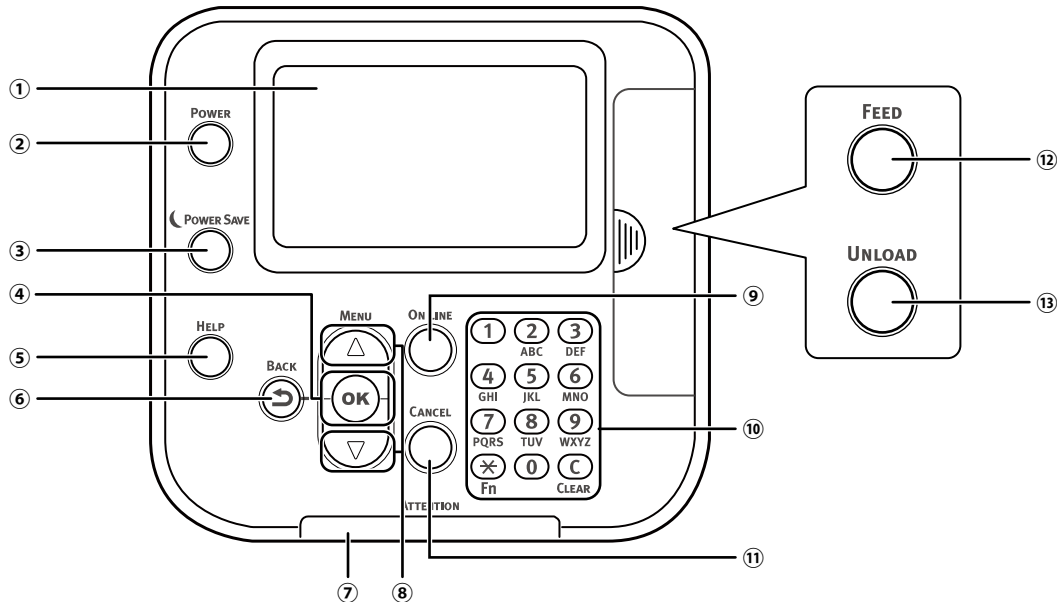

① Display screen

- Shows the printer's status and menus.
- The standby screen shows either of two displays: "Supplies Life display" or "Unwinder Config display".*1

② <POWER> button

- Turns the main power supply of the printer on or off.
- Pressing this button while in the off mode turns on the main power supply.

③ <POWER SAVE> button

- Enters or exits the Power Save Mode.
- This button is lit green in the Power Save Mode.

④ <OK> button (menu button)

- Executes the currently selected menu item or applies the setting being configured.

⑤ <HELP> button

- Displays the Help Screen.
- This button lights orange when you can refer to help messages describing the error that has occurred and providing information about how to clear the error.

⑥ <BACK> button

- Goes back to the previous screen.

⑦ ATTENTION lamp

- Indicates the printer's status.
- This lamp is unlit when the status is normal.
- An error causes this lamp to light or flash orange.

⑧ Scroll buttons ▲ and ▼ (menu buttons)

- Use these buttons to select menu screen items, and to scroll menu pages forward or back.
- On a value input screen, these buttons are used when inputting values.

⑨ <ON LINE> button

- Switches between online and offline.
- This button is lit green while the printer is online and unlit when offline.

⑩ Numeric keypad (1 to 0, *, C)

- The numeric keypad is used when inputting numeric values or passwords.
- Pressing the <*> (<Fn>) key while the standby screen is displayed displays the "Function Number Input" screen for inputting a number that directly accesses menu items.

⑪ <CANCEL> button

- Cancels an ongoing print job or setting operation.

⑫ <FEED> button*2

- Feeds paper.

⑬ <UNLOAD> button*2

- Unloads paper.

*1: Refer to "Standby Screen" (P.25) regarding how to switch the standby screen of the control panel.

*2: Covered in the factory default configuration.

Using the Control Panel

This section describes the main operations that can be performed using the control panel, and provides information about interpreting LCD contents.

The standby screen shows either of two displays: "Supplies Life display" or "Unwinder Config display".*1

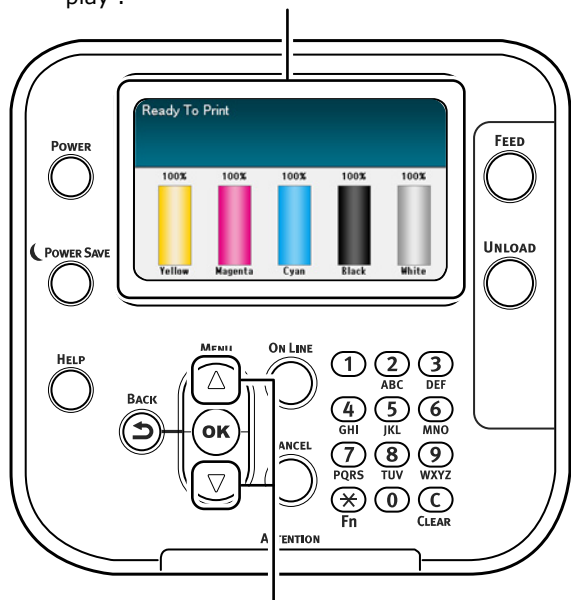

The currently selected item is highlighted.

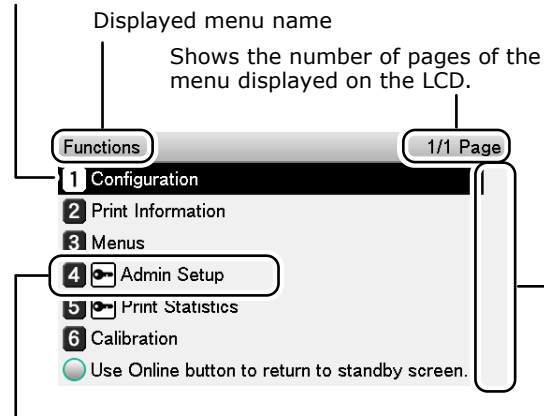

If there is a scroll bar, it means there are menu items that are currently not visible on the LCD. Press the scroll buttons ▲ and ▼ to display them.

A password must be input to access the [Admin Setup]. On the Password Input Screen, input the admin password (factory default: 999999).

Pressing the scroll button ▲ or ▼ displays the [Functions] menu screen shown to the right.

- When a menu item represents a next-level menu or a selection of setting options, selecting the item and then pressing the <OK> button displays the applicable screen.
- While a setting is displayed, pressing the <OK> button applies it. (A  appears to the left of the value.)

*1: Refer to "Standby Screen" (P.25) regarding how to switch the standby screen of the control panel.

■ Standby Screen

The standby screen shows either of two displays: "Supplies Life display" or "Unwinder Config display".

Use the procedure below to switch between the two standby screen displays.

- 1 Press either the scroll button ▲ or ▼ on the control panel to display the "Functions" screen.

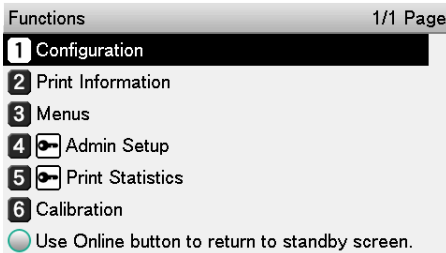

- 2 Press the scroll button ▼ several times to select [Admin Setup], and then press the <OK> button.

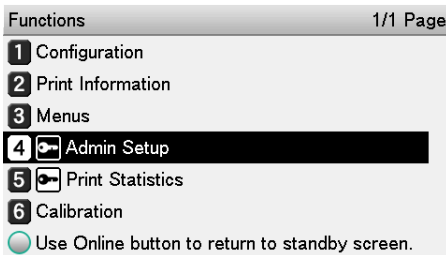

- 3 Use the numeric keypad to input the administrator password. The factory default password is 999999. Press the <OK> button after inputting each character.

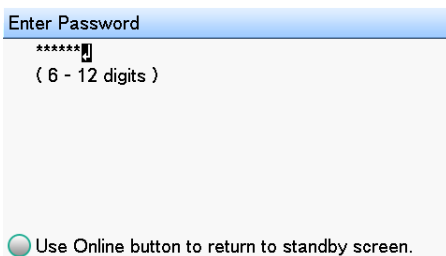

- 4 Press the <OK> button.

- 5 Press the scroll button ▼ several times to select [Panel Setup], and then press the <OK> button.

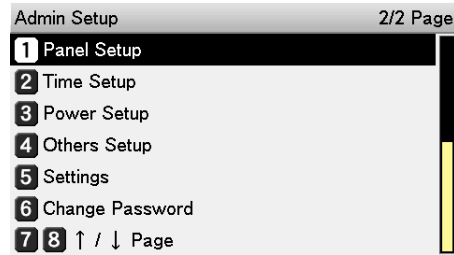

- 6 Press the scroll button ▼ several times to select [Idle Display], and then press the <OK> button.

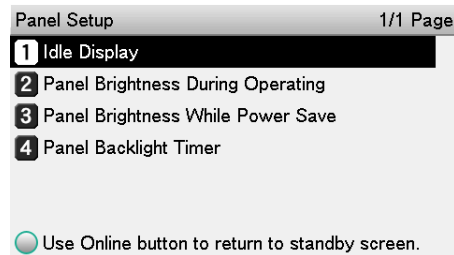

- 7 To show the "Supplies Life display", select the [Supplies Life], and then press the <OK> button. If you want to display the "Unwinder Config display", select the [Unwinder Config], and then press the <OK> button.

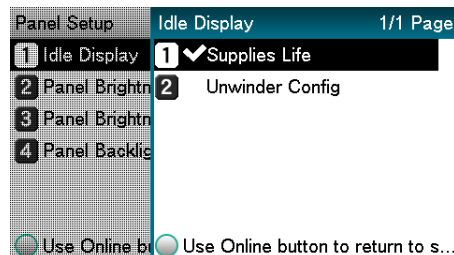

- 8 Press the <ON LINE> button to return to the standby screen.

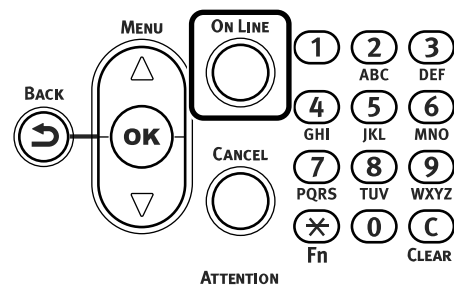

■ Error Screen

When a problem occurs on the printer, the ATTENTION lamp lights or flashes, and a message appears on the LCD.

Depending on the error, information about how to clear the error also appears in addition to the message.



Reference

- "Maintenance Guide"

Pressing a control panel button while an error screen is displayed changes the status of the printer as described below.

<POWER SAVE> button:

Puts the printer into the Power Save Mode. Pressing the <POWER SAVE> button while the printer is in the Power Save mode returns to the standby screen.

<HELP> button:

If the <HELP> button is lit, pressing it displays information about how to clear the displayed error.

<OK> button:

If the error message indicates a clearable error, pressing the <OK> button returns to the standby screen.

<ON LINE> button:

If the error message indicates a clearable error, pressing the <ON LINE> button returns to the standby screen.

<CANCEL> button:

The errors listed below can be canceled with the <CANCEL> button.

- Press the <UNLOAD> button and replace paper.
- There is no paper on the unwinder.
- Restart printing from the page below.
- Cut the paper and start printing.
- Insufficient memory. Print data is too large.

■ Help Screen

Press the <HELP> button to display the Help Screen. If the <HELP> button is lit, pressing it displays information about how to clear the displayed error.

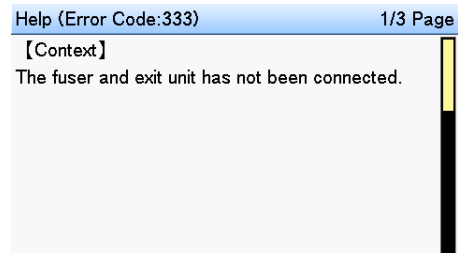

While a help screen is displayed, pressing the scroll button ▲ scrolls to the previous page. Pressing the scroll button ▼ scrolls to the next page.

To exit the help screen, press the <HELP> button again.



Memo

- Long pressing the scroll button ▲ or ▼ scrolls the page for approximately 0.5 seconds.
- The help screen can also be closed by pressing the <BACK> button, <ON LINE> button, or <CANCEL> button.

Using the Numeric Keypad

The numeric keypad is used when inputting numeric values or alphabetic characters.

Each press of a key cycles through the characters assigned to it as shown below.

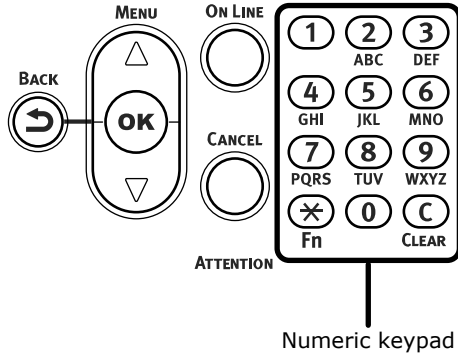

- <1> 1
- <2> 2→a→b→c→2
- <3> 3→d→e→f→3
- <4> 4→g→h→i→4
- <5> 5→j→k→l→5
- <6> 6→m→n→o→6
- <7> 7→p→q→r→s→7
- <8> 8→t→u→v→8
- <9> 9→w→x→y→z→9
- <0> 0

The numeric keypad also has two other keys, whose functions are described below.

<Fn> key:

Pressing this key displays a shortcut to the function number. (Enabled when standby screen is displayed.) When inputting a value, this key is used to cycle through symbols.

<CLEAR> key

When inputting a password, pressing this key deletes a single character.



- To input "abc," press the following: <2> → <2> → <OK> button → <2> → <2> → <2> → <OK> button → <2> → <2> → <2> → <OK> button

■ Function Number Input Screen

While "Ready to print" is displayed on the standby screen, pressing the <Fn> key and then inputting a number displays the corresponding menu.

- 1 Press the <Fn> key.

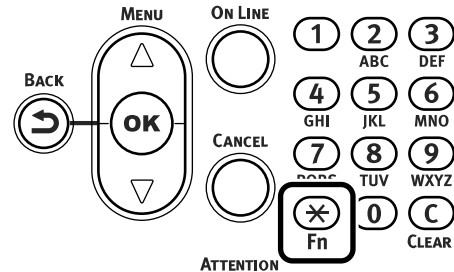

- 2 On the function number input screen that appears, use the numeric keypad to input a two- or three-digit number, and then press the <OK> button.

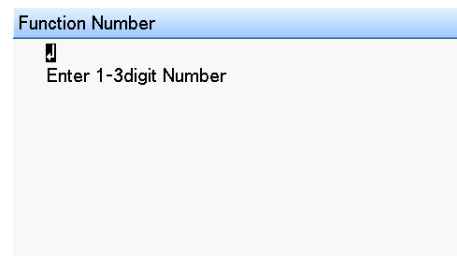

- 3 On the menu that appears, you can check the current setting and change it, if you want.

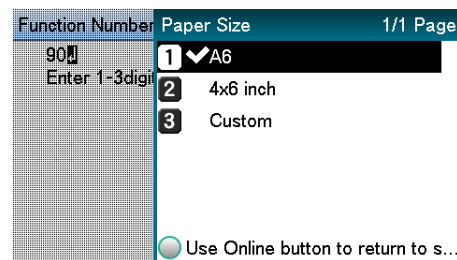

Function Number List

Function Number	Function Number Menu Item
90	Paper Size
91	X Dimension *1
92	Y Dimension *1
93	Media Type
94	Media Weight
100	Print Information (Configuration)
102	Print Information (Usage Report)
103	Print Information (Error Log)
200	Power Save Time
202	Auto Power Off Time
210	Error Report
220	Print Position Adjust
230	Media Transfer Setting Black
231	Media Transfer Setting Color
234	SMR Setting
235	BG Setting
236	Drum Cleaning
237	Hex Dump
238	Transfer Roller Cleaning
300	Adjust Density
301	Adjust Registration
302	Print Color Tuning Pattern
310	Cyan Density
311	Magenta Density
312	Yellow Density
313	Black Density
314	White Density
890	Unwinder Config
891	Media Form
892	Adjust Cut Position
893	Sensor Calibration *2
894	Check Media Pitch *2
895	Cut Mode











*1: Enabled only if the paper size is set to [Custom].







*2: Refer to the "User's Guide" for details.

● Turning on and off the Power Supply

Precautions about the Electric Power

WARNING

	<ul style="list-style-type: none"> ● Be sure to turn off the power switch before attaching or removing the power cord or ground wire. Leaving the power turned on could result in a fire or electric shock.
	<ul style="list-style-type: none"> ● Be sure to connect the ground wire to a dedicated ground terminal. Using the equipment without a ground wire connected could result in a fire or electric shock. If you cannot connect to ground, contact the dealer where you bought the equipment.
	<ul style="list-style-type: none"> ● Never connect a ground wire to a water pipe, gas pipe, telephone wire ground, lightning rod, or anything similar. Fire, electric shock, or gas explosion could result.
	<ul style="list-style-type: none"> ● Always hold the power cord by the plug when you plug or unplug it. Pulling on the power cord could damage the power cord and result in a fire or electric shock.
	<ul style="list-style-type: none"> ● Plug the power plug securely all the way into the power socket. Not plugging it all the way in could result in a fire or electric shock.
	<ul style="list-style-type: none"> ● Do not plug or unplug the power plug if your hands are wet. Electric shock could result.
	<ul style="list-style-type: none"> ● Do not step on or place objects on the power cord. The cord could be damaged and result in a fire or electric shock.
	<ul style="list-style-type: none"> ● Do not use the power cord while it is tied or bundled up. The cord could overheat, be damaged and result in a fire or electric shock.
	<ul style="list-style-type: none"> ● Do not use a damaged power cord. Fire or electric shock could result.
	<ul style="list-style-type: none"> ● Do not plug too many power cords into a single power socket. Fire or electric shock could result.

	<ul style="list-style-type: none"> ● Do not connect other electronic products to the same power socket as the machine. The machine may malfunction due to the electronic noise particularly if you connect an air conditioner, copier, shredder, or other device at the same time. If you must connect them to the same power socket, use a commercially available noise filter or noise cut transformer.
	<ul style="list-style-type: none"> ● Do not use extension cords. If you use an extension cord, the drop in AC voltage may cause the machine to not operate correctly. If you must use one, use the thing more than rated 15 A. Fire or electric shock could result if you use one that is outside the specified range.
	<ul style="list-style-type: none"> ● Do not turn off the power or unplug the power plug while printing. Damage or electric shock could result.
	<ul style="list-style-type: none"> ● If the equipment will not be used for a long period, such as during an extended holiday or vacation, unplug the power cord to be safe.
	<ul style="list-style-type: none"> ● Use the power cord provided with the machine. Do not use a power cord from a different product. Electric shock or fire could result.
	<ul style="list-style-type: none"> ● The power cord provided with the machine is for the machine only. Do not use it for a different product. Electric shock or fire could result.
	<ul style="list-style-type: none"> ● Operations are not guaranteed when using a UPS (uninterruptible power source) or inverter. Do not use an uninterruptible power source or inverter. There is a risk of fire.

Power source conditions

The following conditions are required for the power source.

Voltage: 110 - 127 VAC (Range 99 - 140 VAC)
220 - 240 VAC (Range 198 - 264 VAC)

Frequency: 50/60 Hz \pm 2%

Note

- If the power source is unstable, use a voltage regulator.
- The machine's maximum power consumption is 1200 W. Be sure that the power source has sufficient capacity.
- Operations are not guaranteed when using a UPS (uninterruptible power source) or inverter. Do not use uninterruptible power source or inverters.

Connecting a Power Cord

- 1 Securely insert the power cord provided into the power connector on the machine.

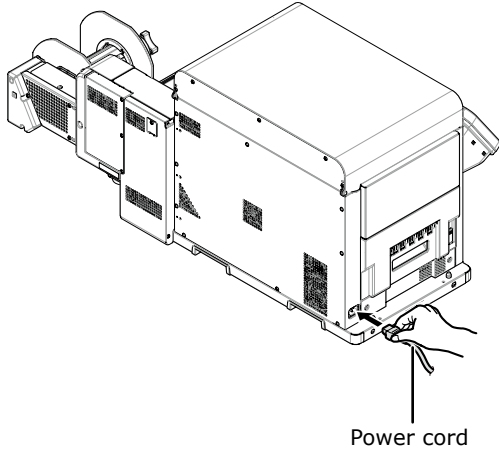

- 2 Plug the power plug into the power socket.

Turning on the Power Supply

- 1 Press and hold the <POWER> button for approximately 1 second.

When the power is turned on, the LED lamp on the <POWER> button turns on.

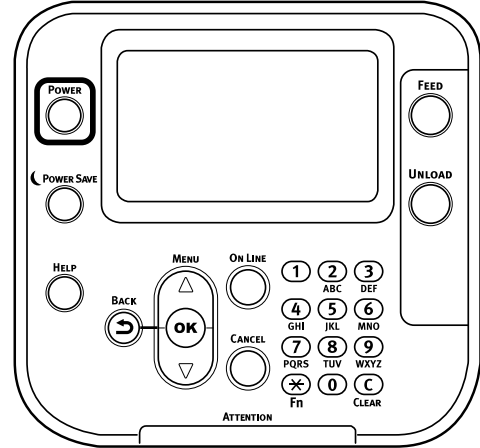

Memo

- When the machine starts, the OKI logo screen appears on the LCD on the control panel. After a short time, the idle display appears and printing is possible.

Turning off the Power

- 1 Press and hold the <POWER> button for approximately 1 second.

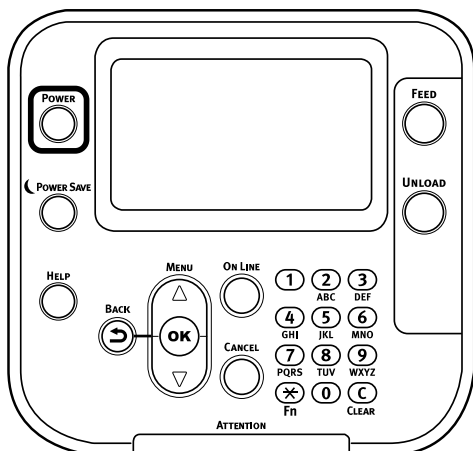

"Shutting down. Please wait. Printer will turn off automatically." appears on the control panel and the LED lamp on the <POWER> button flashes at one second intervals.

Wait a moment, and the machine's power automatically turns off and the LED lamp on the <POWER> button turns off.

Memo

- Pressing on the <POWER> button for five seconds or longer forces the power to turn off. Do this only if some trouble occurs. Refer to the "Maintenance Guide" regarding trouble with the machine.



- Do not touch the power plug or power socket if your hands are wet. There is a risk of electric shock.
- Do not insert any metal objects, such as a screw driver, into the power socket. There is a risk of electric shock.

● Connecting to a PC

This section describes how to connect the printer to a computer and how to install the printer driver from the included software DVD-ROM. You need to have a computer with a DVD drive connected for installation.

Flow for Installing the Driver on a Computer

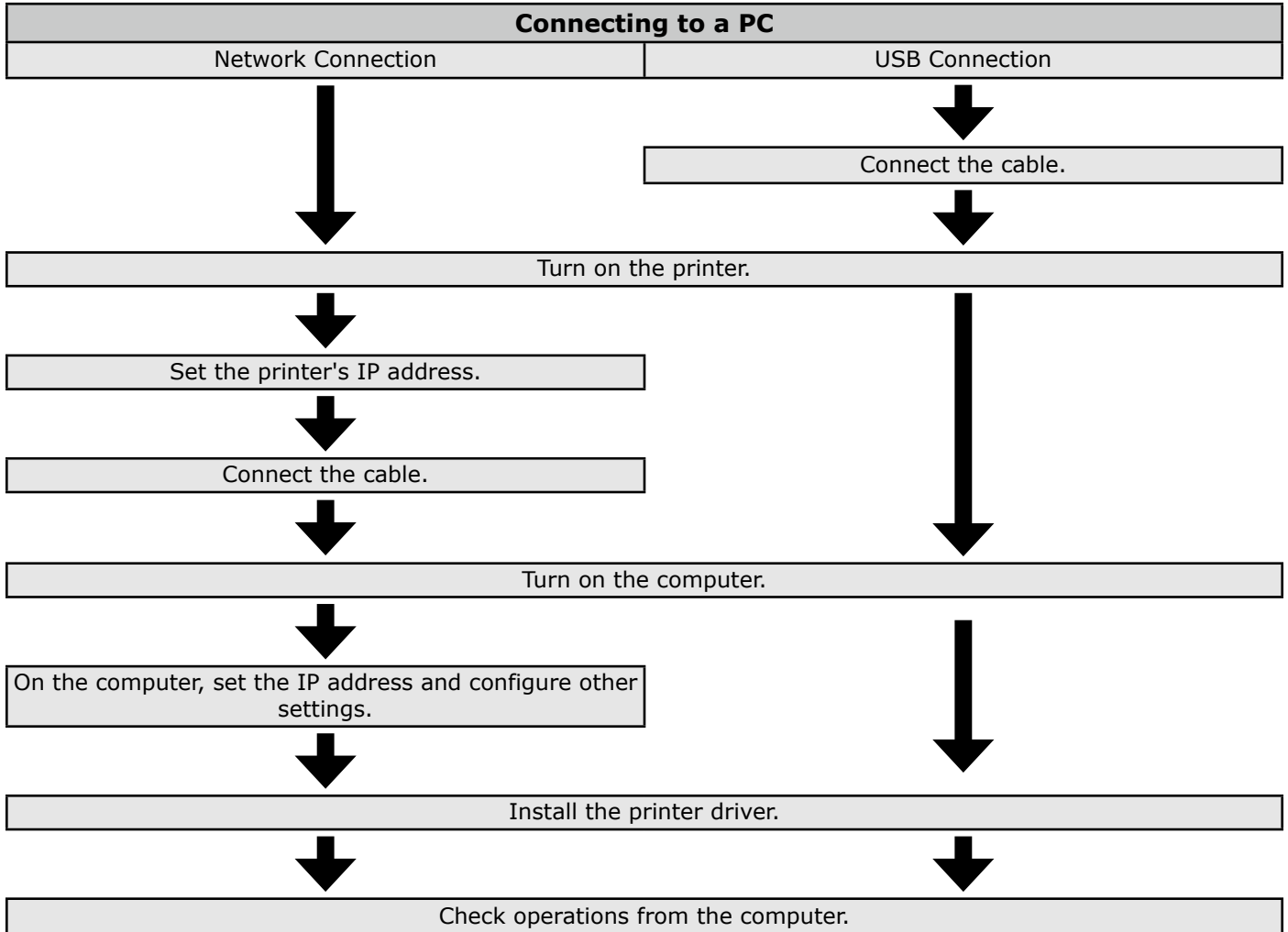

Operating Environment

This printer supports the operating systems (OS) listed below.

- Windows 10/Windows 10 (64-bit version)
 - Windows 8.1/Windows 8.1 (64-bit version)
 - Windows 8/Windows 8 (64-bit version)
 - Windows Server 2016
 - Windows Server 2012 R2
 - Windows Server 2012
 - Windows 7/Windows 7 (64-bit version)
 - Windows Server 2008 R2
 - Windows Server 2008/Windows Server 2008 (x64 version)
- * With Windows 10, Windows 8.1 and Windows 8, only the desktop mode is supported.

Connecting Cables

This printer can connect to a computer or a network.

It comes with a LAN (network) interface connector and a USB interface connector as standard. A LAN cable can be used to connect to a network, while a USB cable can be used to connect to a computer.

LAN Cable Connection

When the printer is connected to a LAN (Ethernet*) or other network, it can be shared by the computers on the network.

* This printer is equipped with a network interface compatible with 10BASE-T/100BASE-TX/1000BASE-T as standard.

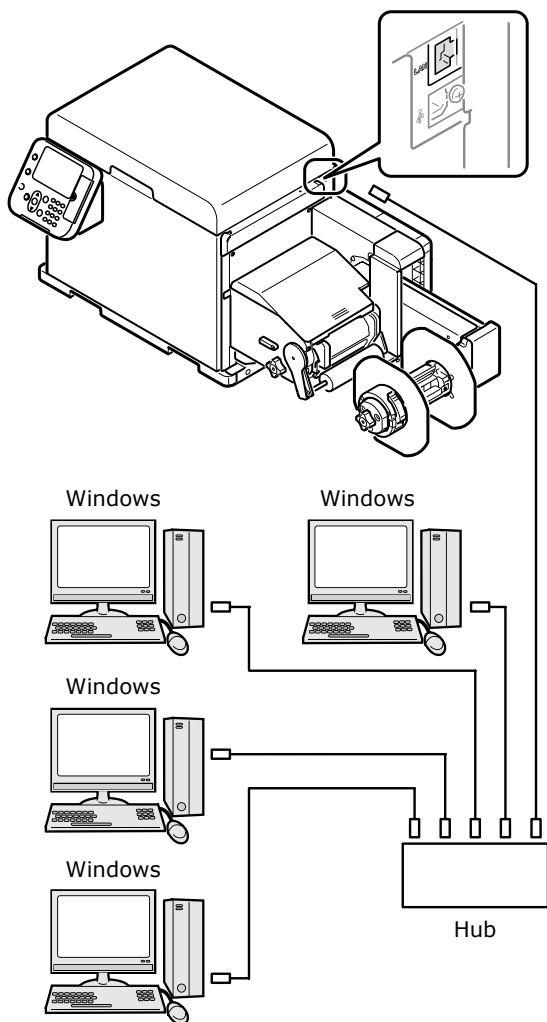

Note

- Connect the cable after completing the settings of this printer.
- If the cable is routed in front of the device, use the cable clamps attached to the unwinder.
- Passing cable through the clamps avoids problems with unwinder operation.

■ Things to Prepare

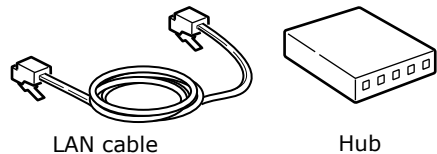

Note

- The printer does not come with a LAN cable or hub. If you need a LAN cable (Category 5e or higher, twisted cable, straight) and hub, it is up to you to prepare them.
- The initial factory defaults setting of the Admin Setup is "Gigabit network: Disabled." This setting needs to be changed in order to use a 1000BASE-T connection. Setting Procedure: On the control panel, input your password in [Admin Setup], and then select [Network Setup] > [Gigabit Network] > [Enable].

■ To Connect a LAN Cable

- 1 Connect the LAN cable to the printer's LAN (network) interface connector (①).

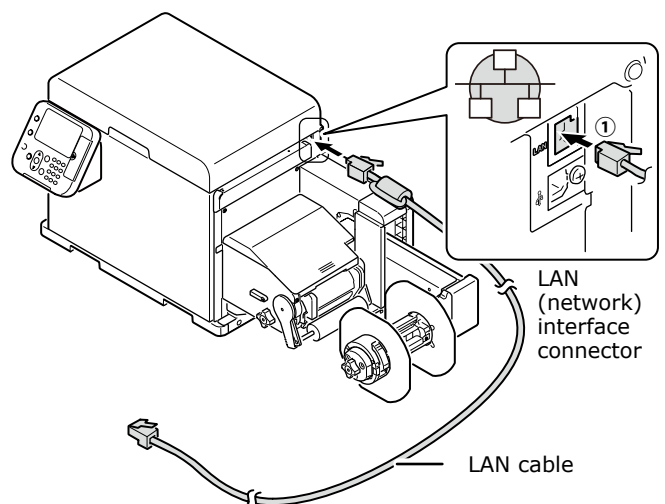

- 2 Connect the other end of the LAN cable to a hub connector (②).

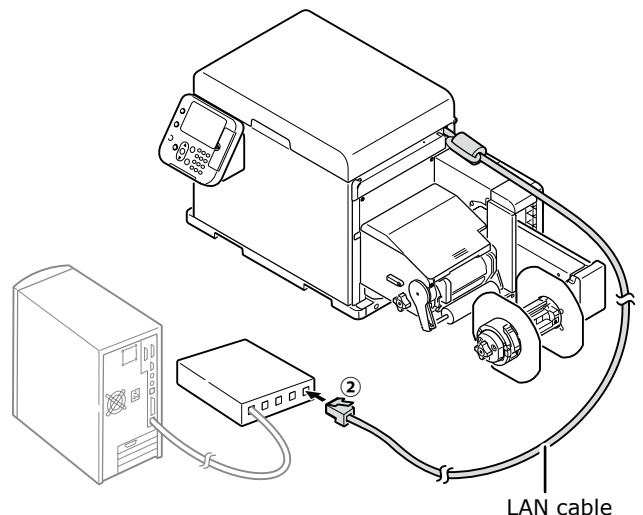

USB Cable Connection

Use this connector when connecting the printer to a computer with a USB cable.

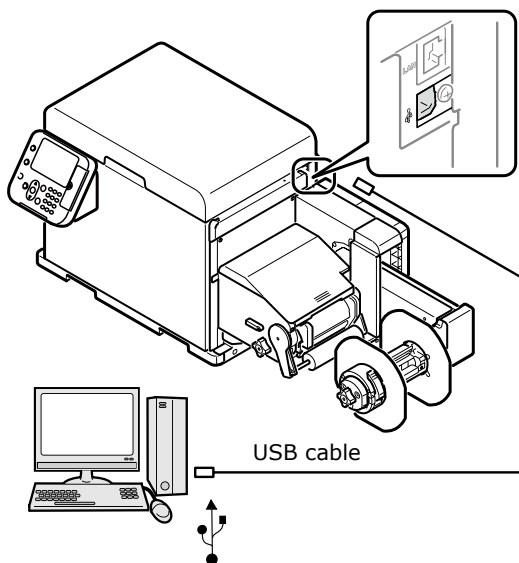

Things to Prepare

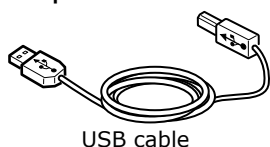

Note

- The printer does not come with a USB cable. You need to prepare a USB 2.0 cable that is no longer than two meters.
- If you are planning to connect using the USB 2.0 Hi-Speed mode, you need to prepare a Hi-Speed USB 2.0 cable.
- USB 3.0 is not supported.

To Connect a USB Cable

- 1 Taking care to orient the connector correctly, connect the square end of the USB cable to the printer (①).

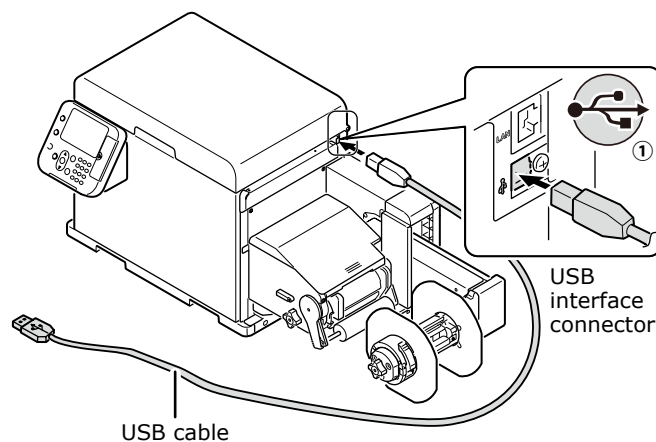

- 2 Connect the other (flat) end of the USB cable to the computer (②).

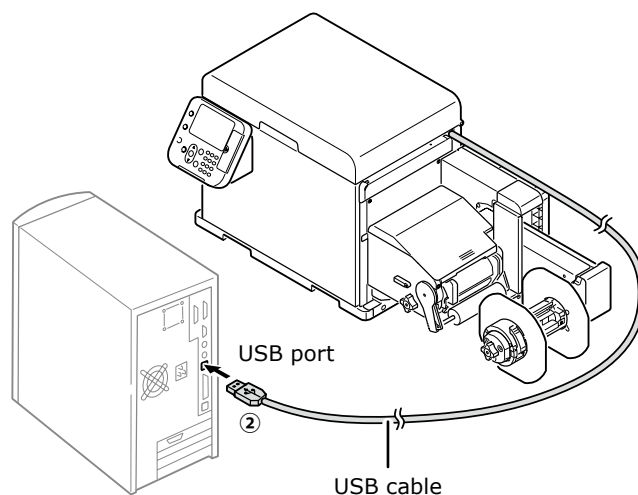

Note

- Do not plug the USB cable into the printer's LAN (network) interface connector. Doing so can cause malfunction of the printer.
- Do not plug or unplug the USB cable while the computer or printer is turned on. Doing so can cause malfunction of the printer.

Memo

- Use the operation panel to configure the printer's USB transfer rate setting in accordance with the transfer rate (speed) of the USB port of the computer.

Installing the Printer Driver

Network Connection

To connect the printer to a computer over a network connection, you first need to set the printer's IP address. Next, install the printer driver on the computer.

If there is no DHCP server or BOOTP server on the network, you need to manually set IP addresses for the computer and printer.

Fixed IP address settings specified by enterprise network administrators, providers, or router manufacturers must also be set manually.

■ Setup Flow

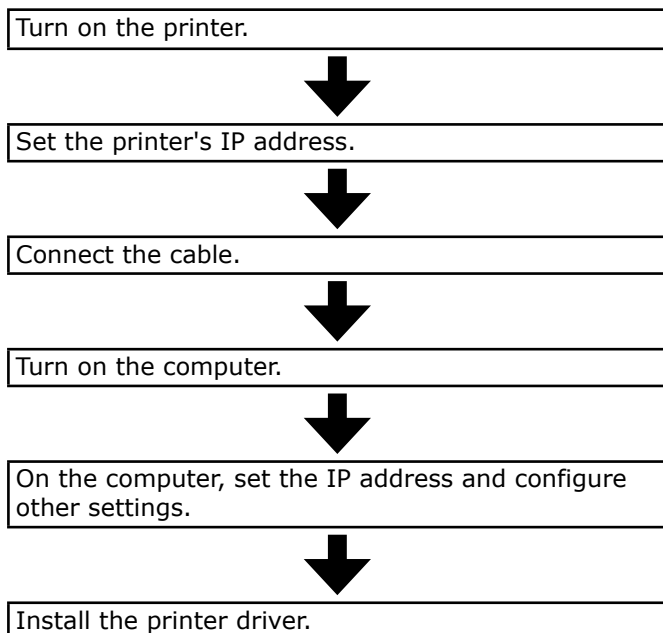

Note

- A wrong IP address can cause a network to go down and make it impossible to connect to the internet. Check with your enterprise network administrator or internet service provider for the IP address you need to set on the printer, etc.
- Servers (DHCP, etc.) existing on a network depend on the network environment. For detailed information, check with your enterprise network administrator, internet service provider, or router manufacturer.
- PC administrator privileges are required for the setup.
- Unless otherwise specified, "Connecting to a PC" (P.32) operations are shown using Windows 10. Depending on the OS, the screens and operation procedures may differ.

■ Setting the Printer's IP Address on the Control Panel



- When configuring a small-scale network to connect the printer to a single computer, set an IP address as shown below (RFC1918 compliant).
 - Computer
 - IP address: Any address from 192.168.0.1 to 254
 - Subnet mask: 255.255.255.0
 - Default gateway: Not used
 - DNS server: Not used
 - Printer
 - IP address specification: Manual
192.168.0.1 to 254 (Use an address different from that of the computer.)
 - Subnet mask: 255.255.255.0
 - Default gateway: 0.0.0.0
 - Network scale: Small

For this example, we show how to configure the settings below.

IP address: 192.168.0.3 (computer)
 192.168.0.2 (printer)

Subnet mask: 255.255.255.0

Gateway address: 192.168.0.1

1 Press either the scroll button ▲ or ▼ on the control panel to display the "Functions" screen.

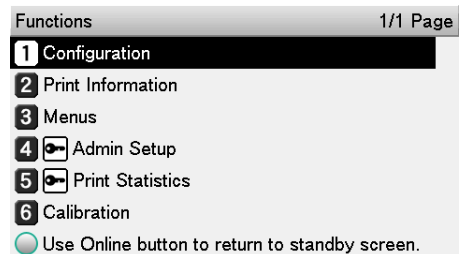

2 Press the scroll button ▼ several times to select [Admin Setup], and then press the <OK> button.

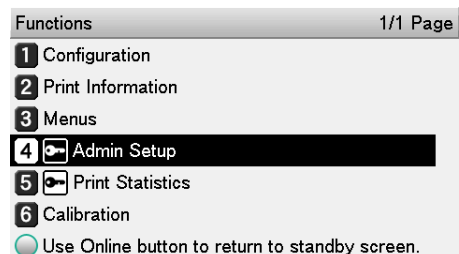

- 3** Use the numeric keypad to input the administrator password.

The factory default password is 999999. Press the <OK> button after inputting each character.

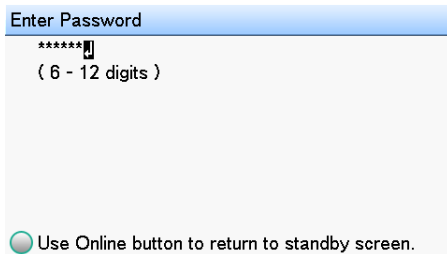

- 4** Press the <OK> button.

- 5** Check that [Network Setup] is selected, and then press the <OK> button.

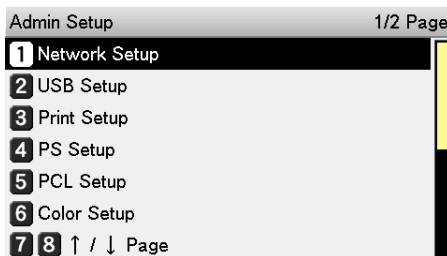

- 6** Press the scroll button ▼ several times to select [IP Address Set], and then press the <OK> button.

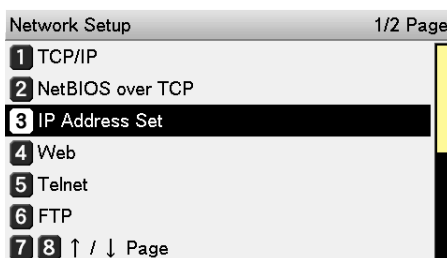

- 7** To set the IP address manually, press the scroll button ▼ to select [Manual], and then press the <OK> button.
→ Go to step 8.

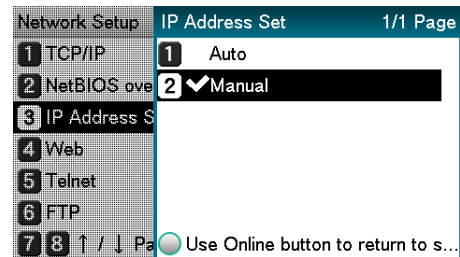

When obtaining an IP address automatically, confirm that [Auto] is selected, and then press the <OK> button.

→ Go to step 14.

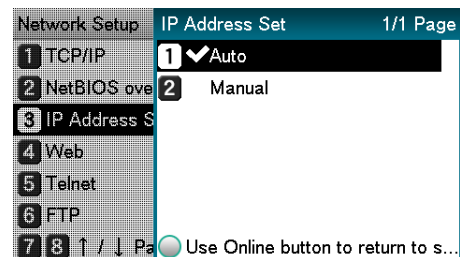

- 8** Press the scroll button ▼ several times to select [IPv4 Address], and then press the <OK> button.

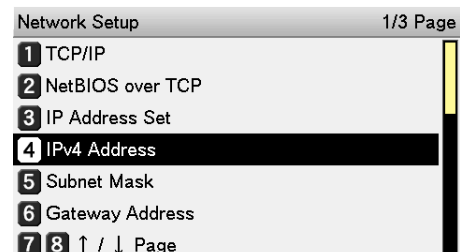

9 Press the scroll buttons ▲ and ▼ or the numeric keypad to input the first three digits of the IP address, and then press the <OK> button. Use the same operation to input the next three digits. After input is complete, press the <BACK> button.

To move to the next box, press the <OK> button.

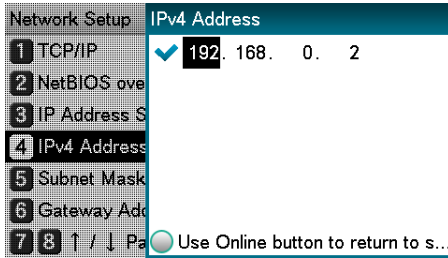

Note

- The IP address in the screen is an example. Check with your enterprise network administrator for the value to actually input.

10 Press the scroll button ▼ to select [Subnet Mask], and then press the <OK> button.

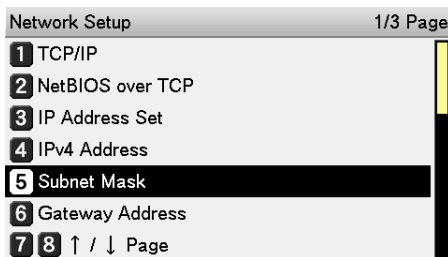

11 Input the subnet mask the same way as the IP address. After input is complete, press the <BACK> button.

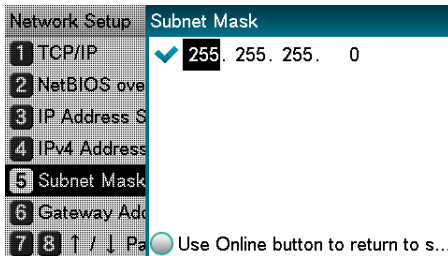

12 Press the scroll button ▼ to select [Gateway Address], and then press the <OK> button.

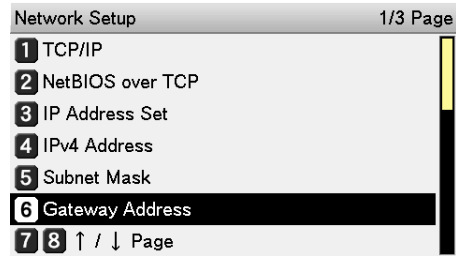

13 Input the gateway address the same way as the IP address. After input is complete, press the <BACK> button.

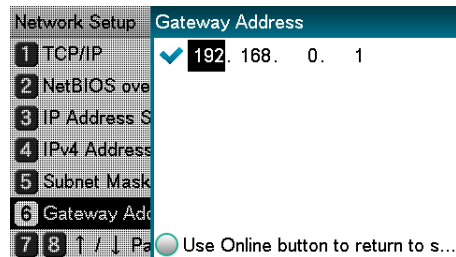

14 Press the <ON LINE> button to exit the network setup.

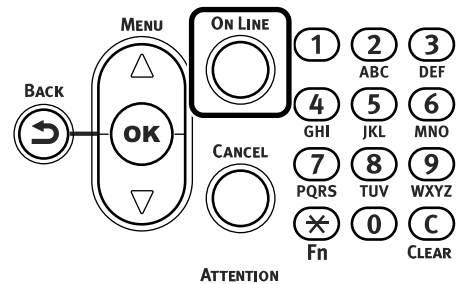

■ Configuring the IP Address and Other Settings on the Computer



- If your computer already has an IP address and other settings configured, or if an IP address is obtained automatically, advance to "To Install the Printer Driver" (P.40).

1 Turn on the computer and start up Windows.

2 Click [Start], and then select [Control panel] in [Windows System].

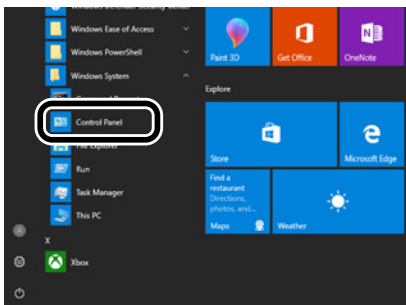

3 Click [View network status and tasks].

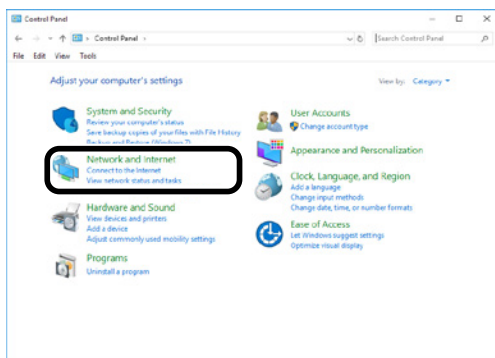

4 Click [Change adapter settings].

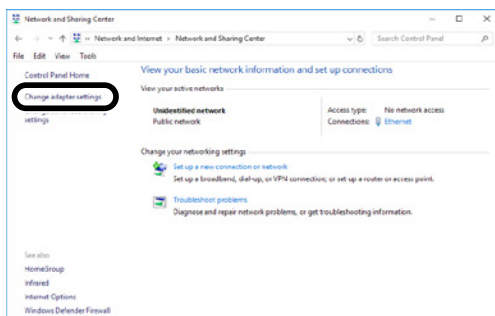

5 Click the icon showing the name of the Network adapter.

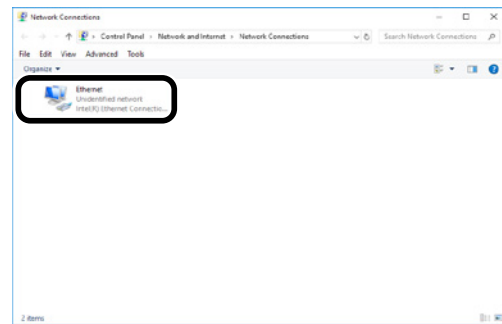

6 On the "Ethernet Status" screen, click [Properties].

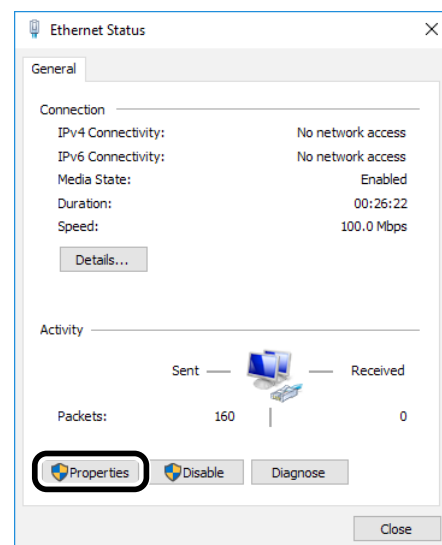

7 Select [Internet Protocol Version 4(TCP/IPv4)], and then click [Properties].

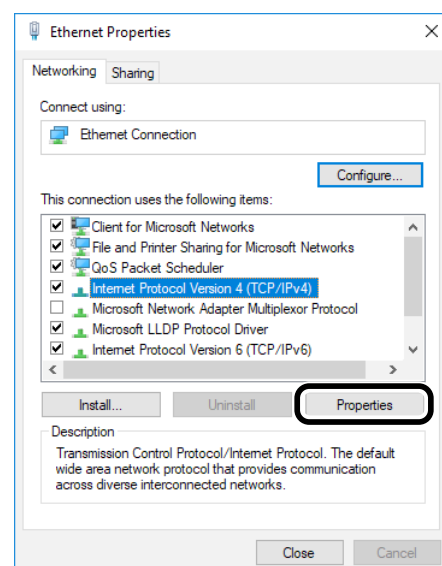

- 8 Input the IP address, subnet mask, default gateway, and DNS server, and then click [OK].

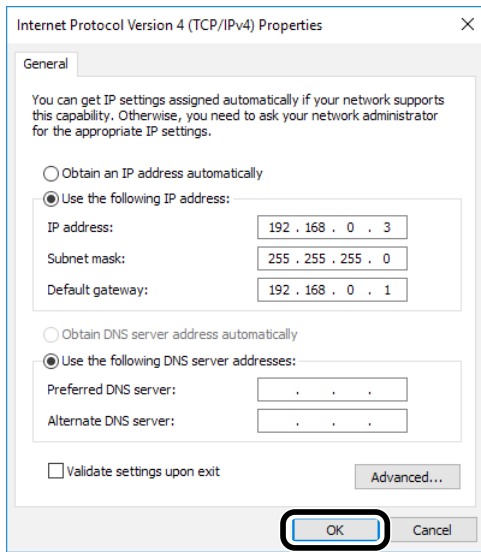

Memo

- When obtaining an IP address automatically from a DHCP server, select [Obtain an IP address automatically] without inputting an IP address.
- If a default gateway or DNS server is not to be used, do not input its address.

- 9 Exit the "Ethernet Properties" screen.

■ To Install the Printer Driver

- 1 Check that the printer is connected to the computer, and then turn on the power.



Reference

- "LAN Cable Connection" (P.34)

- 2 Insert the "Software DVD-ROM" into the computer and click the DVD detection message after it appears at the lower right of the screen.

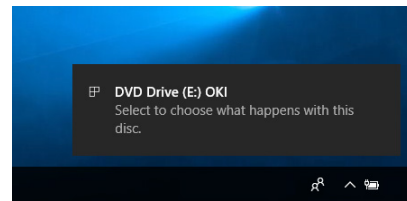

- 3 When the operation selection screen for the DVD-ROM is displayed, click [Run Setup.exe].

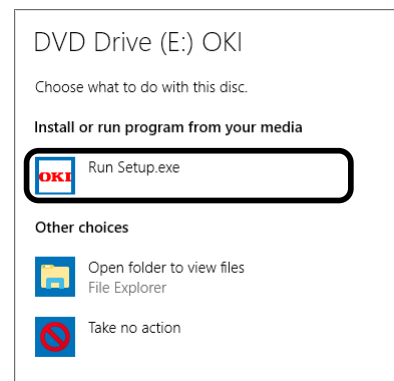

- 4 When the "User Account Control" window is displayed, click [Yes].

- 5 Read the "Software License Agreement", and then click [Accept].

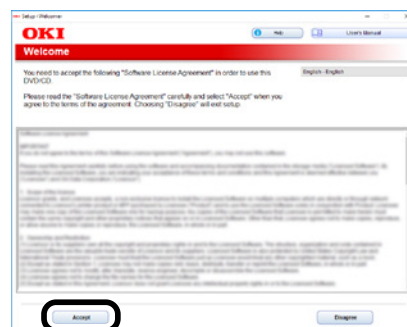

6 Select [Network], and then click [Next].



7 The driver searches for printers. After supported printers are detected, select this printer from the list, and then click [Next].

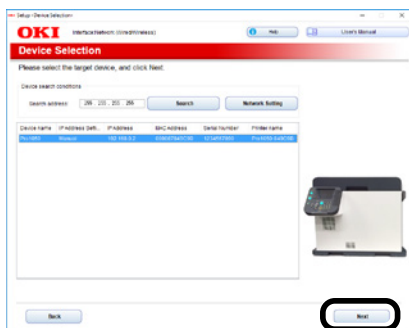

8 Click [Install Optional Software].

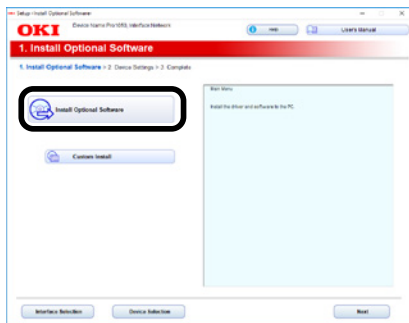

9 After installation is complete, click [Complete].

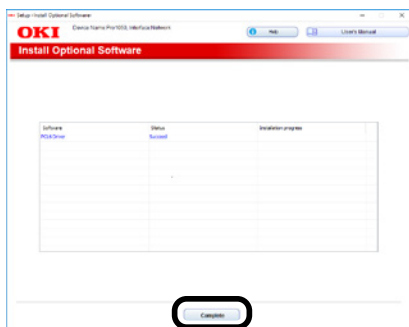

10 The network administrator password and the language of the control panel can be changed as necessary on this screen.

If changes are unnecessary or completed, click [Next].

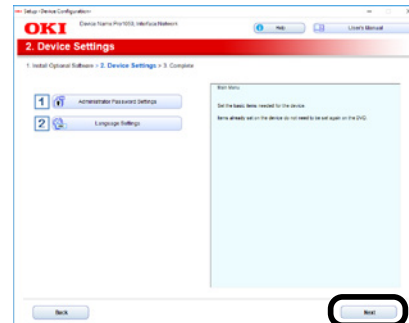

11 Click [Exit] > [Yes].

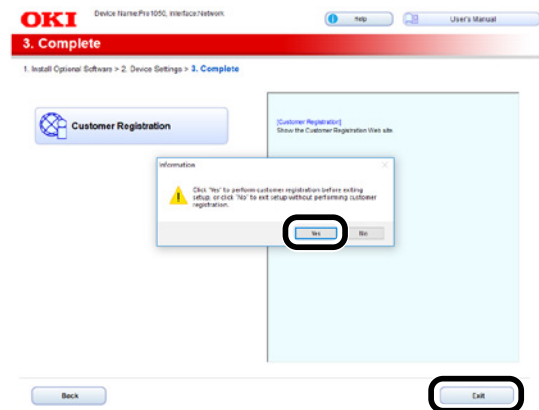

12 Clicking [Yes] starts a web browser and opens the user registration screen. Follow the on-screen instructions to complete user registration.

13 Click [Start] and select [Control Panel] in [Windows System].

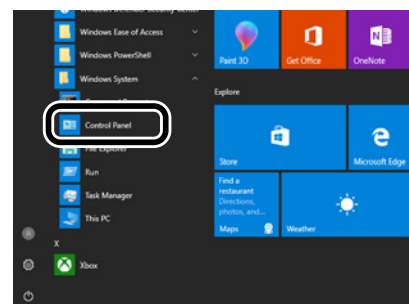

14 Click [View devices and printers].

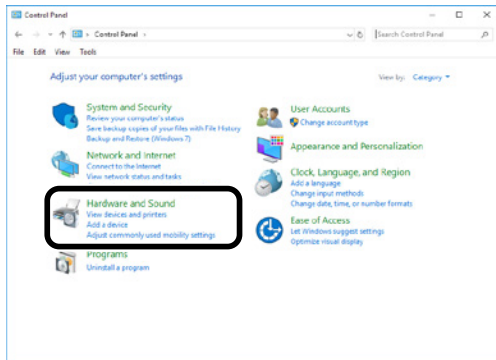

15 Confirm that the Pro1050 icon is displayed.

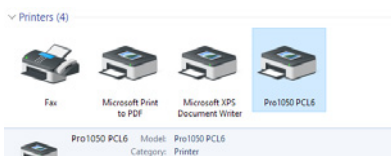

16 Remove the "Software DVD-ROM" from the computer.

Note

- After installing the printer driver, if you click [Print Test Page] in the screen below, the layout of the image skews in the printed results when you print a test page, which is caused by the type of OS you are using. This is not a problem. It is caused by the OS transmitting the images on A4 or letter size paper, which are paper sizes that the device does not support.

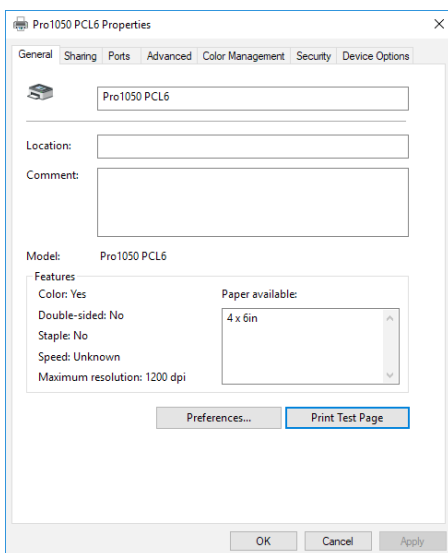

Connecting with USB

Note

- Confirm that the printer is turned off.
- PC administrator privileges are required for the setup.
- Unless otherwise specified, operations here are shown using Windows 10. Depending on the OS, the screens and operation procedures may differ.

■ Setup Flow

Turn on the printer.



Turn on the computer.



Install the printer driver.

- 1 Turn on the power supply of the printer.
- 2 Turn on the computer and start up Windows.
- 3 Insert the "Software DVD-ROM" into the computer and click the DVD detection message after it appears at the lower right of the screen.

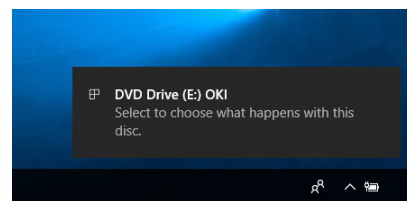

4 When the operation selection screen for the DVD-ROM is displayed, click [Run Setup.exe].

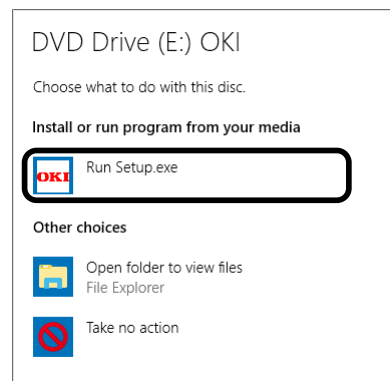

5 When the "User Account Control" window is displayed, click [Yes].

6 Read the "Software License Agreement", and then click [Accept].

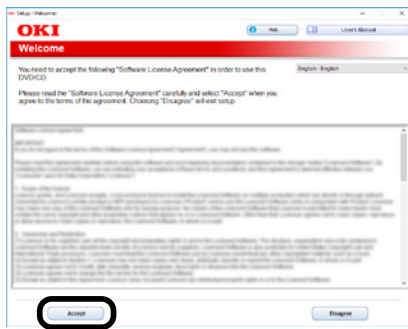

7 Select [USB connection], and then click [Next].

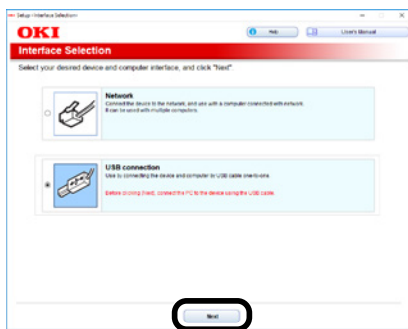

8 Select the detected device, and then click [Next].

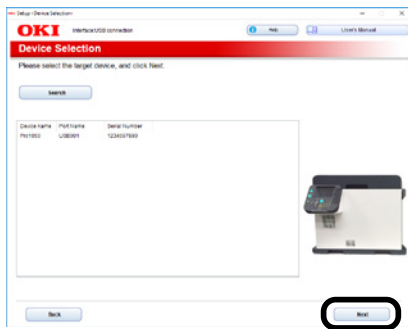

9 Click [Install Optional Software] to start installation.

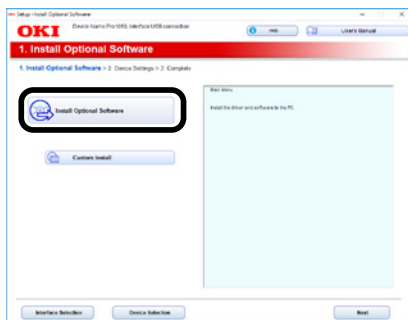

10 After installation is complete, click [Complete].

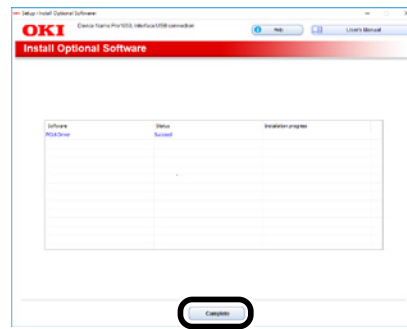

11 The network administrator password and the language of the control panel can be changed as necessary on this screen. If changes are unnecessary or completed, click [Next].

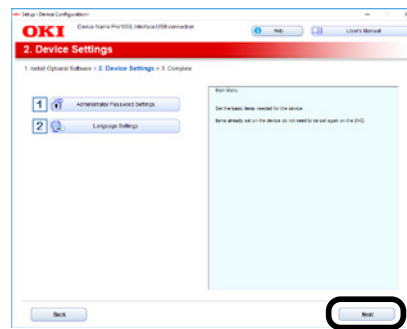

12 Click [Exit] > [Yes].

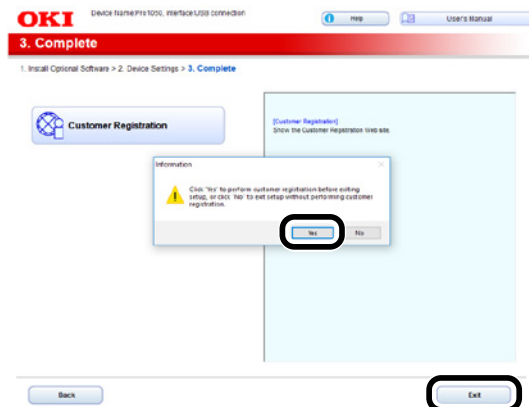

13 Clicking [Yes] starts a web browser and opens the user registration screen. Follow the on-screen instructions to complete user registration.

14 Click [Start] and select [Control Panel] in [Windows System].

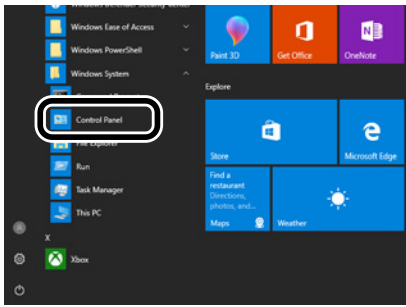

15 Click [View devices and printers].

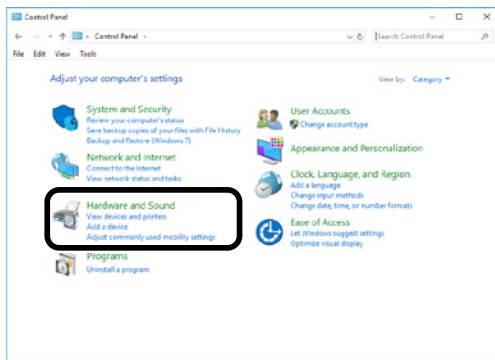

16 Confirm that the Pro1050 icon is displayed.

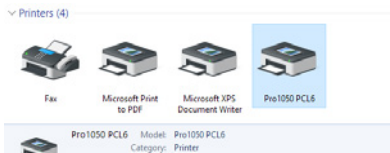

17 Remove the "Software DVD-ROM" from the computer.



- After installing the printer driver, if you click [Print Test Page] in the screen below, the layout of the image skews in the printed results when you print a test page, which is caused by the type of OS you are using. This is not a problem. It is caused by the OS transmitting the images on A4 or letter size paper, which are paper sizes that the device does not support.

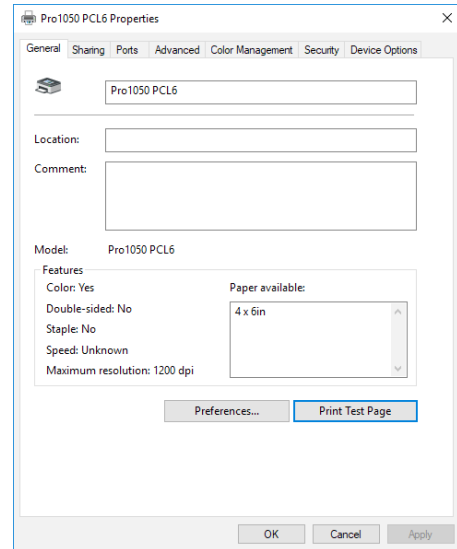

Dealing with Setup Problems

If you run into problems while setting up a network connection or USB connection, refer to the attached "Maintenance Guide".

This section describes possible problems that may occur while operating the printer, and recommended steps to resolve them.

Oki Electric Industry Co., Ltd.
1-7-12 Toranomom, Minato-ku, Tokyo
105-8460, Japan

46938702EE Rev3

<https://www.oki.com/printing/>