

MC563/ES5463 MFP

User's Manual



Table of contents

1	Before starting	4
	Cautions Related to Safety	5
	General Cautions	6
	About This Manual	8
	About Descriptions	8
	Trademarks and Other Information	10
	License	12
2	Setting Up	13
	Installation Requirements	14
	Installation Environment	14
	Installation Space	15
	Checking the Accessories	17
	Unpacking and Installing the Machine	18
	Installing the Optional Equipment	22
	Installing the Wireless LAN module	22
	Installing the Additional Tray Unit	23
	Setting the Printer Driver	25
	Connecting a Telephone Line	27
	Connecting to the Public Line (If Using Only for Faxes)	27
	Connecting to the Public Line (If Connecting a Telephone to the Machine)	28
	Connecting the Optical IP telephone	29
	Connecting to the ADSL Environment	30
	Connecting PBX, Home Telephone or Business Phone	31
	Connecting as an Extension Telephone	31
	Connecting a CS Tuner or Digital Television	32
	Connecting the Power Code	33
	Connecting a LAN Cable/USB Cable	35
	Connecting a LAN Cable	35
	Connecting a USB Cable	37
	Loading Paper in the Tray	39
	Checking the Setting Information	41
	Setting Up This Machine	42
	Language Setup	42
	Setting the Administrator Password	43
	Easy Setup	43
	Connecting to a Wireless LAN (Only When the Wireless LAN Module is Mounted)	45

	Before Connecting to a Wireless LAN	45
	Enabling Wireless LAN Connection	46
	Connecting to an Access Point (Infrastructure)	47
	Connecting to the Machine Directly	51
	Installing a Driver and Software to a Computer	53
	For Windows	53
	For Mac OS X	56
3	Basic Operations	60
	Names of Components	61
	Front View	61
	Rear View	62
	Inside of the machine	63
	Basic Operations on the Operator Panel	64
	Names and Functions	64
	Name and Functions on the Operator Panel	65
	Adjusting the Angle of the Display Screen	66
	Entering Characters	66
	Turning the Machine On or Off	68
	Turning the Machine On	68
	Turning the Machine Off	69
	Loading Paper	70
	About Paper Types That Can be Loaded	70
	Loading Paper in Tray 1/2/3	73
	Loading Paper in the MP Tray	74
	Paper Storage	76
	Setting a Document	77
	About Documents That Can be Set	77
	Setting in the ADF	78
	Setting on the Document Glass	80
4	Copy	81
	Copying	82
	Cancelling Copying	83
	Specifying the Number of Copies	84
5	Scan	85
	Sending Scanned Data as an E-mail Attachment	86
	Before Using Scan To E-mail	86
	Entering E-mail Address to Send E-mail	87
	Saving Scanned Data in a Shared Folder	88

Creating a Shared Folder in a Computer	88	If the Error Code is "391", "392", "393"	143
Registering a Destination (Profile)	89	If the Error Code is "409"	145
How to Use Scan To Shared Folder	90	If a Document Jam Occurs	151
Cancelling Scanning	91	If a Document is Visible in the Paper Path	151
6 Print	92	If a Document is Invisible in the Paper Path	152
Printing from a Computer (Windows)	93	Copy Problems	154
For Windows PCL Printer Driver	93	Unable to Copy	154
For Windows PS Printer Driver	94	Scan Problems	156
Printing from a Computer (Mac OS X)	96	Unable to Scan	156
Cancelling a Print Job	97	Print Problems	157
About Screens and Functions of Each Printer Driver	98	Unable to Print	157
Windows PCL Printer Driver	98	Fax Problems	159
Windows PS Printer Driver	100	Unable to Send a Fax	159
Mac OS X PS Printer Driver	102	Unable to Receive a Fax	160
7 Fax	107	If an Error Message is Displayed on the Operator Panel	161
Basic Operations of Fax Functions	108	Error Message List	161
Entering Fax Number to Send a Fax	108	10 Operating Management/ Specifications	171
Cancelling a Fax Transmission	109	Changing the Administrator Password	172
Setting for Receptions	110	Saving Power Consumption with the Power Save Function	173
Setting the Reception Mode	110	Setting the Length of Idle Time Before Entering Power Save Mode	173
DRD	111	Setting the Length of Idle Time Before Entering Sleep Mode	174
Setting the Waiting Time from When an Incoming Call Arrives to When Reception Starts (Response Waiting Time)	112	Restrictions in Power Saving Function	174
8 Maintenance	113	Automatically Turning the Machine Off (Auto Power Off)	175
Replacing Consumables	114	Setting the Length of Idle Time Before Auto Power Off Works	176
Cautions When Replacing Consumables	114	Specifications	177
Replacing the Toner Cartridges	115	General Specifications	177
Replacing the Image Drum	119	Copier Specifications	178
Replacing the Image Drum and Toner Cartridge at the Same Time	123	Fax Specifications	178
Cleaning Each Part of the Machine	127	Scanner Specifications	179
Cleaning the Document Glass	127	Printing Specifications	179
Cleaning the LED Head	128	Network Specifications	180
9 Troubleshooting	130	Wireless LAN Specifications (Option)	181
If Paper Jams Occur	131	Contact Us	182
If the Error Code is "370", "371", "372"	131		
If the Error Code is "380", "381", "382", "385", "389"	136		
If the Error Code is "390"	140		

1

Before starting

[Cautions Related to Safety](#)



[General Cautions](#)

[About This Manual](#)









[Trademarks and Other Information](#)









[License](#)



Cautions Related to Safety



 WARNING	Indicates additional information which, if ignored or not followed, may result in personal injury or death.
 CAUTION	Indicates additional information which, if ignored, may result in personal injury.

General Cautions

 WARNING	
	Do not touch the safety switch inside this machine. High voltage may occur, resulting in electric shock. Also, a gear may rotate, resulting in injury.
	Do not use a highly combustible spray near this machine. Some parts inside the machine become very hot, possibly resulting in fire.
	If the cover becomes extremely hot, the machine emits smoke or odor, or you hear a strange sound, unplug the power plug from the outlet, and contact your dealer. Fire may result.
	If liquid such as water gets inside the machine, unplug the power plug from the outlet, and contact your dealer. Fire may result.
	If you drop a clip or other foreign objects into the machine, unplug the power plug from the outlet, and take the foreign objects out. Electric shock, fire, or injury may result.
	Do not perform any operation or disassembly other than instructed in the user manual. Electric shock, fire, or injury may result.
	If the machine is dropped or the cover is damaged, unplug the power plug from the outlet, and contact your dealer. Electric shock, fire, or injury may result.
	Unplug the power plug regularly, and clean the bases of and in between the plug blades. If the power plug is left plugged into the outlet for an extended period of time, dust adheres on the bases of the plug blades, and a short may occur, possibly resulting in fire.

 WARNING	
	Do not vacuum spilled toner with an electric vacuum cleaner. Vacuuming spilled toner with an electric vacuum cleaner may result in ignition due to sparks from electric contacts or other reasons. If toner spills on the floor or other places, wipe the toner gently with a damp rag or other cloth while using care not to scatter the toner.
	Do not insert any object into a vent hole. Electric shock, fire, or injury may result.
	Do not place a cup filled with water or other objects on the machine. Electric shock or fire may result.
	Do not let pet urine or other liquid get inside this machine, or allow this machine to get wet. Electric shock or fire may result.
	When the machine cover is opened, do not touch the fuser unit. Burns may result.
	Do not throw the toner cartridge or image drum into a fire. The toner may ignite, resulting in burns.
	Do not connect the power cord, cables, or the ground wire in any way other than instructed in the user manual. Fire may result.
	Operation using an UPS (uninterruptible power supply) or inverter is not guaranteed. Do not use an uninterruptible power supply or inverter. Fire may result.

 CAUTION	
	Do not go near the paper output part when you turn the power on or when printing is in progress. Injury may result.

 CAUTION	
	Do not touch a broken liquid crystal display. Injury may result. If you get liquid (liquid crystal) spilled from the liquid crystal display into your eyes or mouth, immediately rinse with a large amount of water. Seek medical advice if necessary.
	Do not disassemble the image drum or toner cartridge, or force them open. You may inhale the scattered toner, or the toner may land on your hands or clothes, making them dirty.

NOTE!

This product is not intended for use in the immediate visual field on the display work place. To avoid disturbing reflections on the display work place, this product shall not be placed in the immediate field of vision.

About This Manual

Various information about this manual is provided here. Read these sections before using this manual.

• Disclaimer

Every effort has been made to ensure that the information in this document is complete, accurate, and up-to-date. The manufacturer assumes no responsibility for the result of errors beyond its control. The manufacturer also cannot guarantee that changes in software and equipment made by other manufacturers and referred to in this manual will not affect the applicability of the information in it. Mention of software products manufactured by other companies does not necessarily constitute endorsement by the manufacturer.

While all reasonable efforts have been made to make this document as accurate and helpful as possible, we make no warranty of any kind, expressed or implied, as to the accuracy or completeness of the information contained herein.

• Copyright of the manual

All rights reserved by Oki Electric Industry Co., Ltd. No part of this document may be reproduced in any form or by any means without prior written permission from Oki Electric Industry Co., Ltd.

© 2017 Oki Electric Industry Co., Ltd.

• Manual Composition

- User's Manual (PDF) ----- Stored in the DVD-ROM which comes with the machine.
- Advanced Manual (PDF) ----- Download this manual from the web site and refer to it.

• [About Descriptions](#)

- [How to Use This Manual \(Advanced Manual\)](#)

About Descriptions

Marks, symbols, illustrations, and other descriptions are provided.

- [About Marks](#)
- [About Symbols](#)
- [About Illustrations](#)



Unless otherwise specified, this manual uses screenshots of the following screens.

- For Windows: Windows 7
- For Mac OS X: Mac OS X 10.9

[OKI MFP] may be written as the model name.

Depending on your OS, model or version, the description on this document may be different.

About Marks

This manual uses the following marks.

Symbol	Meaning
	Indicates the cautions and restrictions for operating this machine correctly. Be sure to read to ensure that you can operate the machine correctly.
	Indicates information that is useful for using this machine. It is recommended to read.
	Indicates a reference topic. Read when you need more information.
	Indicates a related topic. Read when you need related information.

About Symbols

This section describes symbols and their meaning in this manual.

Symbol	Meaning
Illustration (button name)	Indicates a button (button name) on the operator panel of the machine.

Symbol	Meaning
[]	Indicates a menu name, item name, option, or other items that are displayed on the display screen on the operator panel. Indicates a menu, window, or dialog box name that is displayed on the screen on a computer. They can be clearly distinguished in descriptions or illustrations in procedures.
" "	Indicates a message on the display screen or entered text. Indicates a file name on a computer. Indicates the topic title of a link destination.
< >	Indicates a key on the computer keyboard.
>	Indicates how to display the required menu of the machine or computer.

About Illustrations

The illustrations of MC563 are used in this manual as examples.

Illustrations of the display screen on the operator panel used in this manual are with the factory default settings.



The descriptions in this manual may vary depending on your model.

Trademarks and Other Information

OKI is a registered trademark of Oki Electric Industry Co., Ltd.

ENERGY STAR is a trademark of the United States Environmental Protection Agency.

Microsoft, Windows, Windows Server, Windows Vista and Internet Explorer are registered trademarks of Microsoft Corporation.

Apple, Macintosh, Mac and Mac OS are the registered trademarks of Apple Inc.

iPad, iPhone, iPod, iPod touch and Safari are trademarks registered to Apple Inc. in the United States and other countries.



AirPrint and the AirPrint logo are trademarks of Apple Inc.

Google, Google Docs, Android, and Gmail are trademarks of Google Inc.

Google Cloud Print is a trademark of Google Inc.

Adobe, Illustrator, Photoshop, PostScript and Reader are trademarks or trademarks of Adobe Systems Incorporated in the United States and other countries.

FeliCa is a registered trademark of Sony Corporation.

MIFARE is a trademark of NXP Semiconductors.

Other product names and brand names are registered trademarks or trademarks of their proprietors.

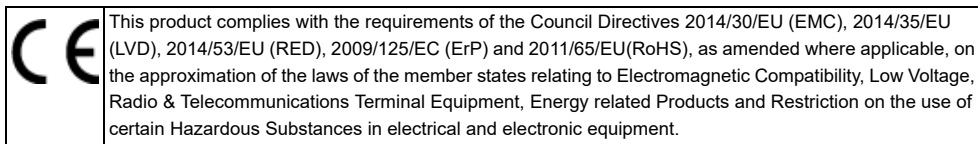

The following cables were used to evaluate this product for EMC directive 2014/30/EU compliance, and configurations other than this may affect that compliance.

CABLE TYPE	LENGTH (METER)	CORE	SHIELD
Power	1.8	X	X
USB	5.0	X	✓
LAN	10.0	X	X
Telephone	3.0	X	X

• ENERGY STAR

Target countries of the ENERGY STAR program are the United States, Canada and Japan.

It is not applicable to other countries.

This product is compliant with ENERGY STAR v2.0 only.

• EMERGENCY FIRST AID

Take care with toner powder:



If swallowed, give small amounts of cold water and seek medical attention. DO NOT attempt to induce vomiting.

If inhaled, move the person to an open area for fresh air. Seek medical attention. If it gets into the eyes, flush with large amounts of water for at least 15 minutes keeping eyelids open. Seek medical attention.

Spillages should be treated with cold water and soap to help reduce risk of staining skin or clothing.

- ENVIRONMENTAL INFORMATION



License

This product contains software developed by the Heimdal Project.

Copyright (c) 1995 - 2008 Kungliga Tekniska Högskolan

(Royal Institute of Technology, Stockholm, Sweden).

All rights reserved.

Redistribution and use in source and binary forms, with or without modification, are permitted provided that the following conditions are met:

- 1 Redistributions of source code must retain the above copyright notice, this list of conditions and the following disclaimer.
- 2 Redistributions in binary form must reproduce the above copyright notice, this list of conditions and the following disclaimer in the documentation and/or other materials provided with the distribution.
- 3 Neither the name of the Institute nor the names of its contributors may be used to endorse or promote products derived from this software without specific prior written permission.

THIS SOFTWARE IS PROVIDED BY THE INSTITUTE AND CONTRIBUTORS "AS IS" AND ANY EXPRESS OR IMPLIED WARRANTIES, INCLUDING, BUT NOT LIMITED TO, THE IMPLIED WARRANTIES OF MERCHANTABILITY AND FITNESS FOR A PARTICULAR PURPOSE ARE DISCLAIMED. IN NO EVENT SHALL THE INSTITUTE OR CONTRIBUTORS BE LIABLE FOR ANY DIRECT, INDIRECT, INCIDENTAL, SPECIAL, EXEMPLARY, OR CONSEQUENTIAL DAMAGES (INCLUDING, BUT NOT LIMITED TO, PROCUREMENT OF SUBSTITUTE GOODS OR SERVICES; LOSS OF USE, DATA, OR PROFITS; OR BUSINESS INTERRUPTION) HOWEVER CAUSED AND ON ANY THEORY OF LIABILITY, WHETHER IN CONTRACT, STRICT LIABILITY, OR TORT (INCLUDING NEGLIGENCE OR OTHERWISE) ARISING IN ANY WAY OUT OF THE USE OF THIS SOFTWARE, EVEN IF ADVISED OF THE POSSIBILITY OF SUCH DAMAGE.

- **Open Source License Disclosure**

The following open source software is included to use Google Cloud Print. The descriptions about the open source license are as follows.

json-c

Copyright (c) 2009-2012 Eric Haszlakiewicz

Permission is hereby granted, free of charge, to any person obtaining a copy of this software and associated documentation files (the "Software"), to deal in the Software without restriction, including without limitation the rights to use, copy, modify, merge, publish, distribute, sublicense, and/or sell copies of the Software, and to permit persons to whom the Software is furnished to do so, subject to the following conditions:

The above copyright notice and this permission notice shall be included in all copies or substantial portions of the Software.

THE SOFTWARE IS PROVIDED "AS IS", WITHOUT WARRANTY OF ANY KIND, EXPRESS OR IMPLIED, INCLUDING BUT NOT LIMITED TO THE WARRANTIES OF MERCHANTABILITY, FITNESS FOR A PARTICULAR PURPOSE AND NON INFRINGEMENT. IN NO EVENT SHALL THE AUTHORS OR COPYRIGHT HOLDERS BE LIABLE FOR ANY CLAIM, DAMAGES OR OTHER LIABILITY, WHETHER IN AN ACTION OF CONTRACT, TORT OR OTHERWISE, ARISING FROM, OUT OF OR IN CONNECTION WITH THE SOFTWARE OR THE USE OR OTHER DEALINGS IN THE SOFTWARE.

Copyright (c) 2004, 2005 Metaparadigm Pte Ltd

Permission is hereby granted, free of charge, to any person obtaining a copy of this software and associated documentation files (the "Software"), to deal in the Software without restriction, including without limitation the rights to use, copy, modify, merge, publish, distribute, sublicense, and/or sell copies of the Software, and to permit persons to whom the Software is furnished to do so, subject to the following conditions:

The above copyright notice and this permission notice shall be included in all copies or substantial portions of the Software.

THE SOFTWARE IS PROVIDED "AS IS", WITHOUT WARRANTY OF ANY KIND, EXPRESS OR IMPLIED, INCLUDING BUT NOT LIMITED TO THE WARRANTIES OF MERCHANTABILITY, FITNESS FOR A PARTICULAR PURPOSE AND NON INFRINGEMENT. IN NO EVENT SHALL THE AUTHORS OR COPYRIGHT HOLDERS BE LIABLE FOR ANY CLAIM, DAMAGES OR OTHER LIABILITY, WHETHER IN AN ACTION OF CONTRACT, TORT OR OTHERWISE, ARISING FROM, OUT OF OR IN CONNECTION WITH THE SOFTWARE OR THE USE OR OTHER DEALINGS IN THE SOFTWARE.

2

Setting Up

Installation Requirements

Checking the Accessories

Unpacking and Installing the Machine

Installing the Optional Equipment

Connecting a Telephone Line

Connecting the Power Code

Connecting a LAN Cable/USB Cable

Loading Paper in the Tray

Checking the Setting Information

Setting Up This Machine

Connecting to a Wireless LAN (Only When the Wireless LAN Module is Mounted)

Installing a Driver and Software to a Computer

Installation Requirements

- [Installation Environment](#)
 - [Installation Space](#)
-

Installation Environment

Install the machine in the following environment.

Ambient temperature: 10°C to 32°C

Ambient humidity: 20% to 80% RH (relative humidity)

Maximum wet bulb temperature: 25°C



- Use care to prevent condensation. It may cause a malfunction.
- If installing your machine where the ambient humidity is 30% RH or below, use a humidifier or antistatic mat.
- Depending on the installation environment, the operation noise may be louder. If the noise bothers you, we suggest you to install the machine in the place away from you or in another room.

WARNING

- Do not install the machine in a location subject to high temperatures or in a location near fire.
- Do not install the machine in a location where chemical reactions may occur (such as a laboratory).
- Do not install the machine near alcohol, thinners, or other flammable solvents.
- Do not install the machine in a location within the reach of small children.
- Do not install the machine in an unstable location (such as on an unsteady stand or slanted location).
- Do not install the machine in a location with high level of humidity or dust, or in a location where the machine is exposed to direct sunlight.
- Do not install the machine in an environment where it is exposed to salty air or corrosive gas.
- Do not install the machine in a location where it is exposed to a high level of vibration.
- Do not install the machine in a location where its vent hole is blocked.

CAUTION

- Do not install this machine directly on a thick rug or carpet.
- Do not install this machine in a closed room or other locations with bad circulation and ventilation.
- If you use this machine in a small room continuously for an extended period of time, make sure to ventilate the room.
- Install this machine away from a source that emits strong magnetic fields or noise.
- Install this machine away from a monitor or television.
- Carry this machine by holding both its sides and slightly slanting its rear side down.

Installation Space

Install the machine on a flat surface that is wide enough to accommodate the legs of the machine.

Allow for enough room around the machine as shown in the following figures.

• Top view

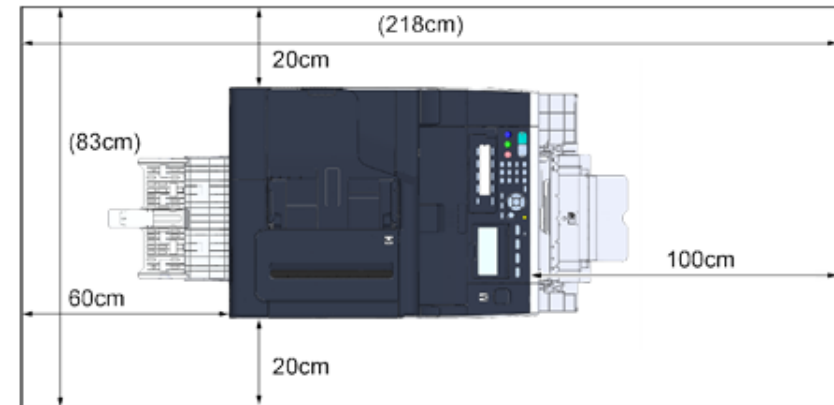

• Side view

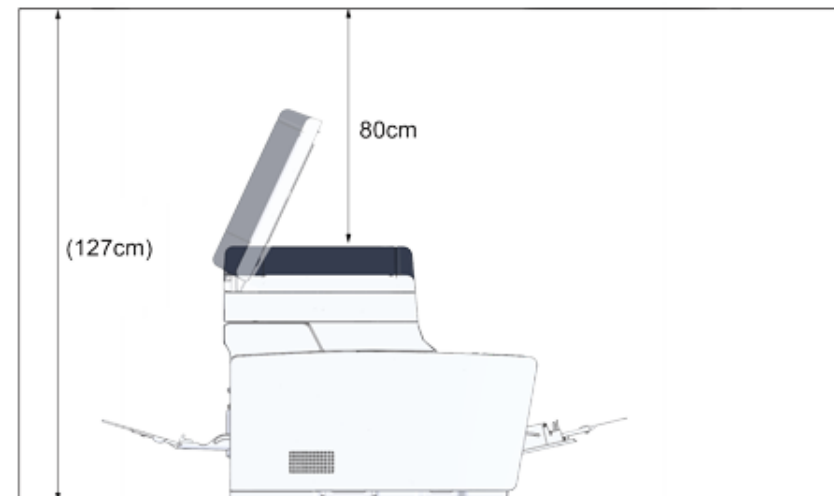

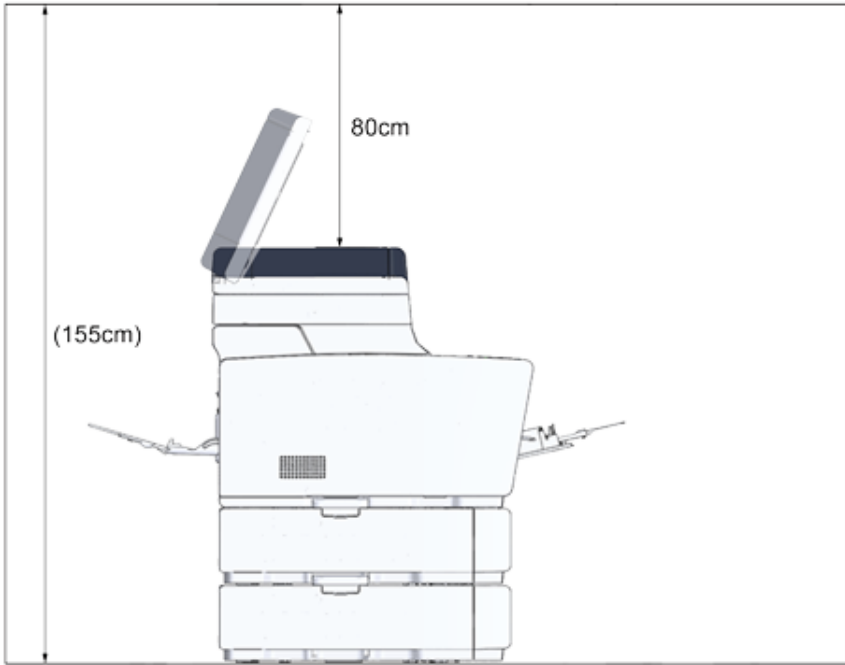

- Side view (when the additional tray unit is installed)



Checking the Accessories

Check that you have everything shown below.

 CAUTION	Injury may result.	
Lift this machine by 2 persons, because it weighs approximately 31 kg.		



Be sure to use the supplied consumables first. If other consumables are used first, the life time may not be shown correctly or supplied consumables may not be applied.

- **Main body**



- **Four image drums (black, cyan, magenta and yellow)**
- **Four starter toner cartridges (black, cyan, magenta and yellow)**

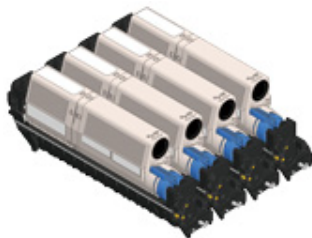

For the MC model, the starter toner cartridges are installed in the image drums, which are installed in the machine before shipment.



The starter toner cartridge is not installed in the ES model. Install the toner cartridge that is included in this machine. Refer to "[Replacing the Image Drum](#)".

- **Software DVD-ROM**



- **Power cord**

- **Telephone cable**



- **Envelope lever**

The envelope lever is attached to the MP tray. Use the envelope lever if envelopes wrinkle after being printed.



For instructions, refer to "Printing on Envelopes (Advanced Manual)".



- LAN cables or USB cables are not included in the package. Prepare the cable that suits your connection environment separately.
- Packaging and cushioning materials are used when transporting the machine. Do not dispose packaging materials as they may be used in the future.

Unpacking and Installing the Machine

This section describes how to unpack and install the machine.

 CAUTION	Injury may result.	
Lift this machine by 2 persons, because it weighs approximately 31 kg.		



- Use extra care when handling the image drum (the green cylinder), because it is fragile.
- Do not expose the image drum to direct sunlight or strong light (approximately 1,500 lux or more). Even under room lighting, do not leave the image drum for 5 minutes or more.
- Packaging and cushioning materials are required for transporting the machine. Do not dispose of it, and keep it for future use.

- 1 Remove the machine from the box, and then remove accessories, cushioning materials and the plastic bag from the machine.

- 2 Lift the machine, and then place it where it is to be installed.



Do not open the scanner unit until step 4.

- 3 Remove the cushioning materials, protection tapes, protective sheet, and desiccant packs.
- 4 Hold the handle (B) to open the scanner unit.

- 5 Press the button (A) and open the output tray (a) until it stops.

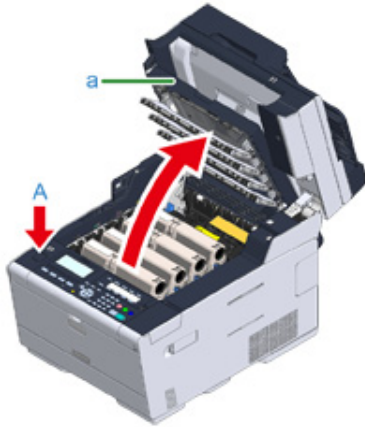

- 6 Pinch the tip of blue lever of the toner cartridge and turn forward until the tip aligns on the lug of the cartridge.

Turn the levers of all 4 toner cartridges.

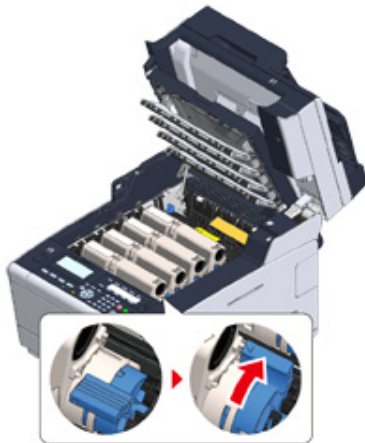

If you close the output tray without turning the blue lever, it may cause a malfunction. Be sure to turn the blue lever until its top aligns on the lug in the back of the toner cartridge.

- 7 Pull the locking levers on the fuser unit toward you to unlock.

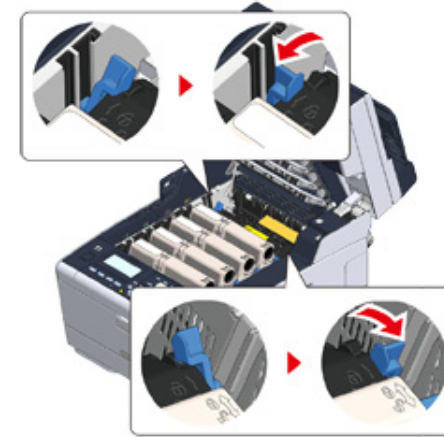

- 8 Hold the fuser unit handle and lift the fuser unit out of the machine.



- 9 Push the blue lever on the fuser unit and remove the orange safety stopper and film.

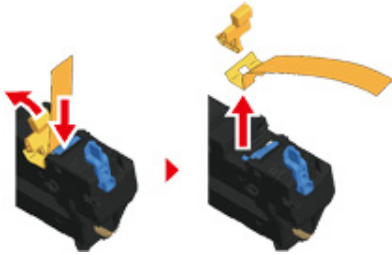

- 10 Hold the fuser unit handle and aligning the fuser unit to the grooves behind the toner cartridges, place the fuser unit into the machine.

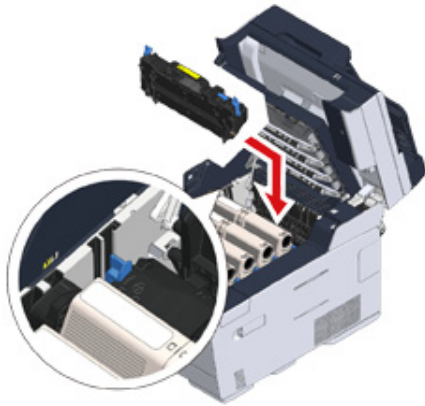

- 11 Push the levers on the fuser unit to lock.

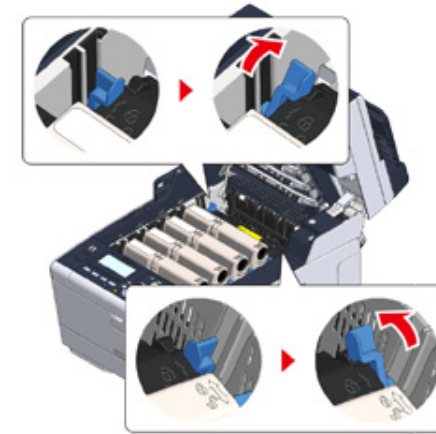

- 12 Close the output tray (a) slowly and push the center of the output tray for confirmation.

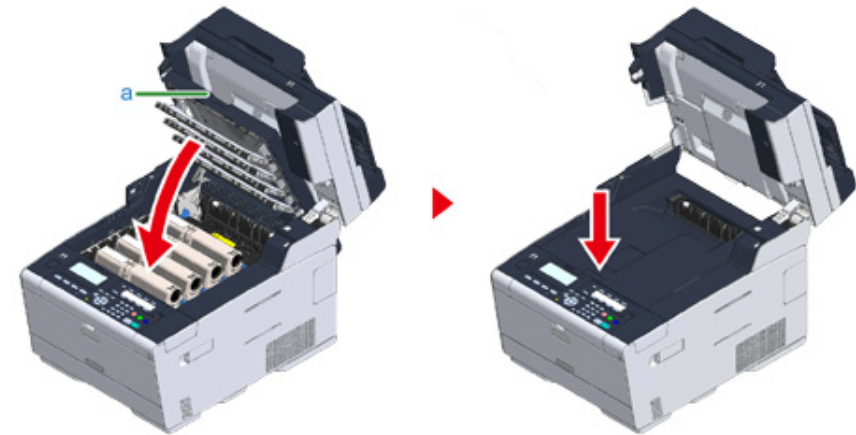

If the error message that the output tray is open does not disappear, make sure that the output tray is closed securely.

13 Hold the handle (B) to close the scanner unit.



Installing the Optional Equipment

This section describes how to install optional equipment.

- [Installing the Wireless LAN module](#)
 - [Installing the Additional Tray Unit](#)
 - [Setting the Printer Driver](#)
-

Installing the Wireless LAN module

Install the wireless LAN module when you want to use a wireless connection.

After installing, be sure to change the wireless LAN setting from [DISABLE] to [ENABLE] on the operator panel.

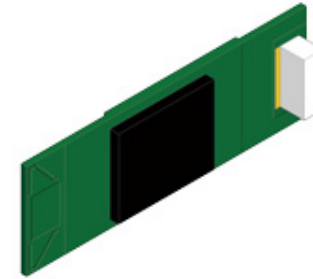

- 1 Check that the machine is turned off and power cord and all the cables are unplugged.



Installing the wireless LAN module with the machine turned on may cause the machine and wireless LAN module to malfunction.

- 2 Open the wireless LAN module cover.



- 3 Eject the connector from the cover and connect with the wireless LAN module.

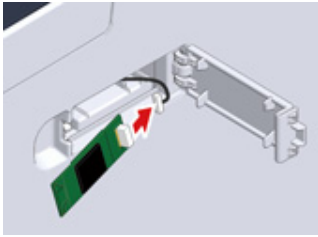

- 4 Install the wireless LAN module to the machine.

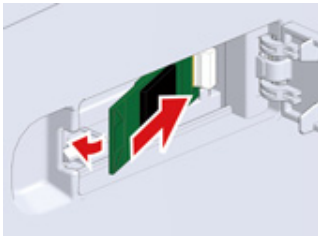

- 5 Close the wireless LAN module cover.

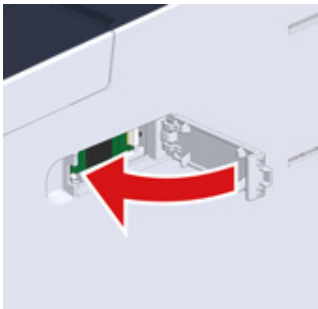

Go to ["Connecting the Power Code"](#).



Attaching the wireless module cannot connect the machine to the wireless LAN.

Enable the wireless setting in the steps in ["Connecting to a Wireless LAN \(Only When the Wireless LAN Module is Mounted\)"](#).

Installing the Additional Tray Unit

Attach the additional tray unit when increasing the number of sheets or paper to be set is needed.

Up to 2 trays can be installed.

Set the number of trays on the printer driver after installing them.

Model Number N36501

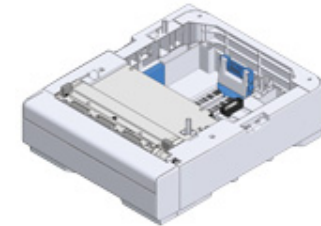

CAUTION

Injury may result.



Lift this machine by 2 persons, because it weighs approximately 31 kg.

- 1 Check that the machine is turned off and power cord and all the cables are unplugged.



Installing the additional tray unit with the machine turned on may cause the machine and additional tray unit to malfunction.

2 If you want to install two additional trays, fix them together with the lock pieces.

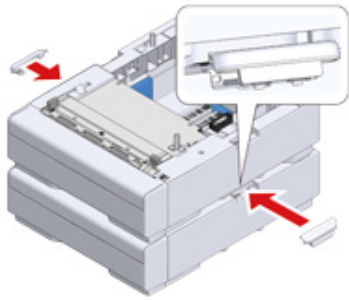

3 Slowly stack the machine on the additional tray unit aligning their back sides and right sides.



4 Screw the machine and additional tray unit with the lock pieces.



Setting the Printer Driver

When the additional tray unit is installed, be sure to set the number of trays after the printer driver is installed.

For the information of installing the printer driver, see "[Installing a Driver and Software to a Computer](#)".



- To follow this procedure, you must log in to a computer as the administrator.
- If your Mac OS applies to the following conditions, the information about the installed option is automatically obtained, not requiring you to set the printer driver.
 - When the optional equipment is installed before the printer driver is installed
 - When the machine is connected to a network over Bonjour
 - When the machine is connected via USB interface

• Setting Additional Tray(s) to the Windows PCL Printer Driver

- 1 Click [Start], and then select [Devices and Printers].
- 2 Right-click [OKI MC563], and then select [OKI MC563 PCL6] from [Printer properties].
- 3 Select the [Device Options] tab.

- 4 Enter the total number of trays and then click [OK].

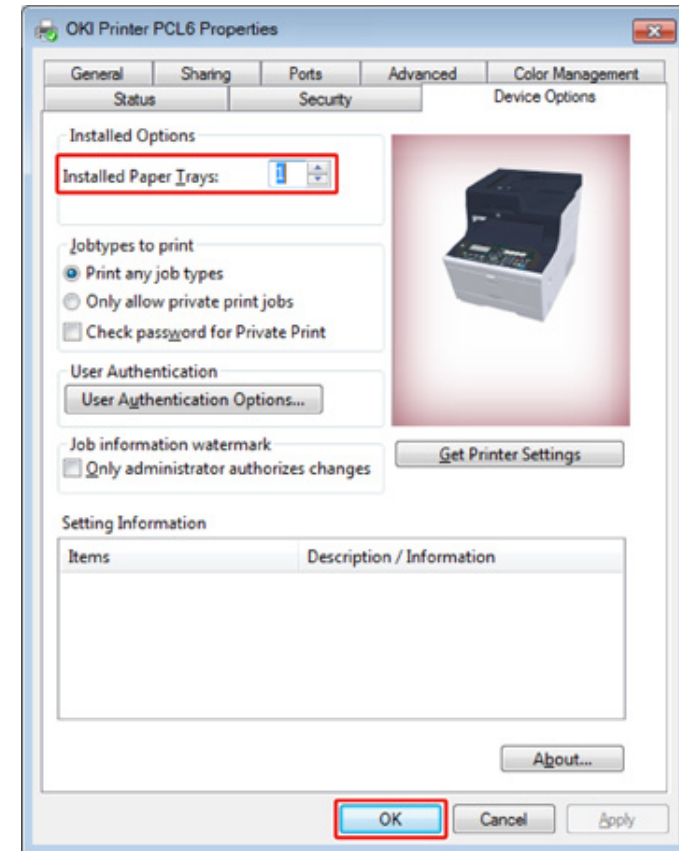

If a TCP/IP network connection is used, click [Get Printer Settings] to set the number of trays automatically.

• Setting Additional Tray(s) to the Windows PS Printer Driver

- 1 Click [Start], and then select [Devices and Printers].
- 2 Right-click [OKI MC563], and then select [OKI MC563 PS] from [Printer properties].
- 3 Select the [Device Settings] tab.

- 4 Select [Get installed options automatically] for [Installable Options], and then click [Setup].

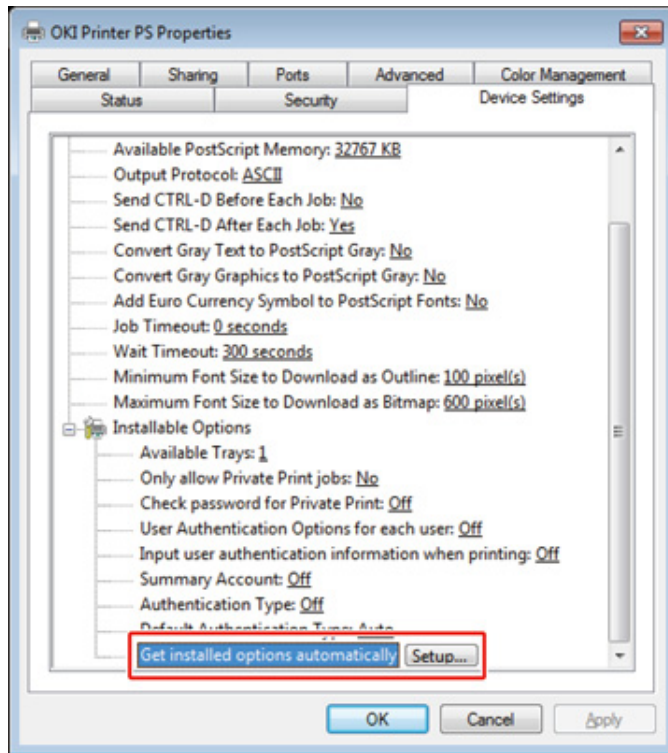

When using a USB connection, select the total number of trays for [Available Trays] in [Installable Options].

- 5 Click [OK].

• Setting Additional Tray(s) to the Mac OS X Printer Driver

- 1 Select [System Preferences] from the Apple menu.
- 2 Click [Printers & Scanners].
- 3 Select the machine, and then click [Options & Supplies].
- 4 Select the [Options] tab.

- 5 Select the total number of trays for [Available Tray], and then click [OK].

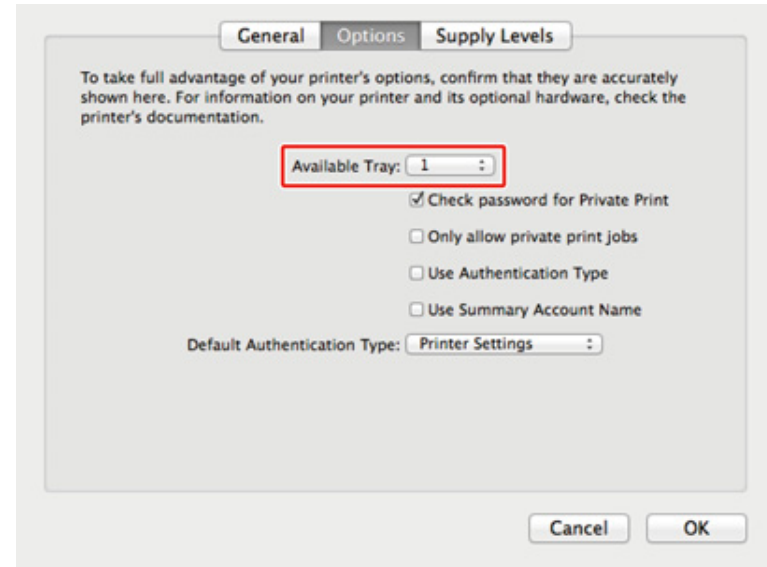

Connecting a Telephone Line

This section describes how to connect a telephone cable for fax transmissions.

The telephone line connection method varies depending on your environment. Connect the telephone cable that suits your environment by referring to the illustrations in this manual.

Set the telephone cable in the recess of the machine so that it is not to be loose.

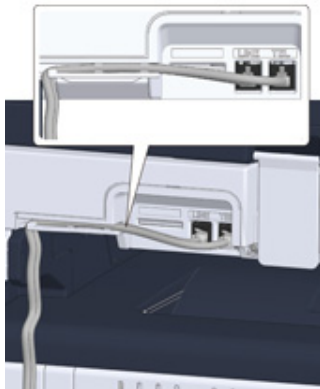

- Always use the telephone cable which comes with the machine. Using another telephone cable may cause a malfunction.
- If a fax transmission or reception fails, set [Super G3] to [OFF].
- You cannot connect an ISDN line directly. To connect, use a terminal adapter (TA) and connect to the LINE connector of the machine.

- [Connecting to the Public Line \(If Using Only for Faxes\)](#)
- [Connecting to the Public Line \(If Connecting a Telephone to the Machine\)](#)
- [Connecting the Optical IP telephone](#)
- [Connecting to the ADSL Environment](#)
- [Connecting PBX, Home Telephone or Business Phone](#)
- [Connecting as an Extension Telephone](#)
- [Connecting a CS Tuner or Digital Television](#)

Connecting to the Public Line (If Using Only for Faxes)

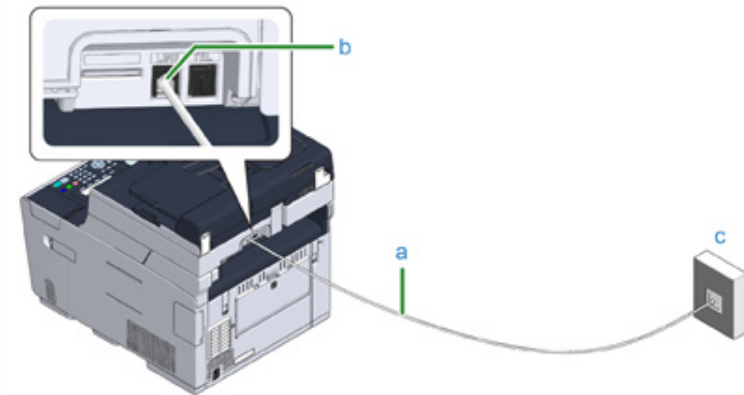

- 1 Plug one end of the included telephone cable (a) into the LINE connector (b) of the machine and the other end into a public line (analog) (c).



Keep the cover of the "TEL connector" inserted.

Connecting to the Public Line (If Connecting a Telephone to the Machine)

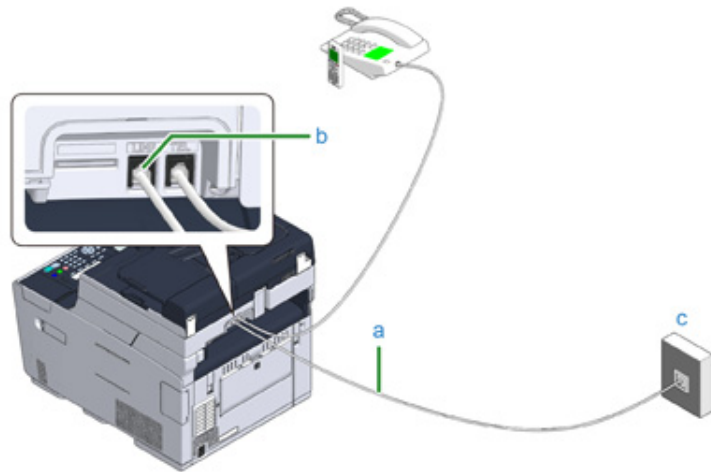

- 1 Plug one end of the included telephone cable (a) into the LINE connector (b) of the machine and the other end into a public line (analog) (c).
- 2 Remove the telephone connector cover (d).

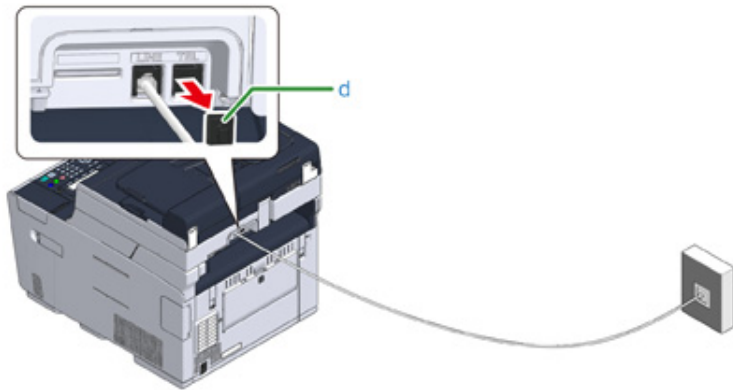

- 3 Plug the telephone cable (f) that is connected to the external telephone into the TEL connector (e) of the machine.

A telephone that is connected to the machine is called an external telephone.

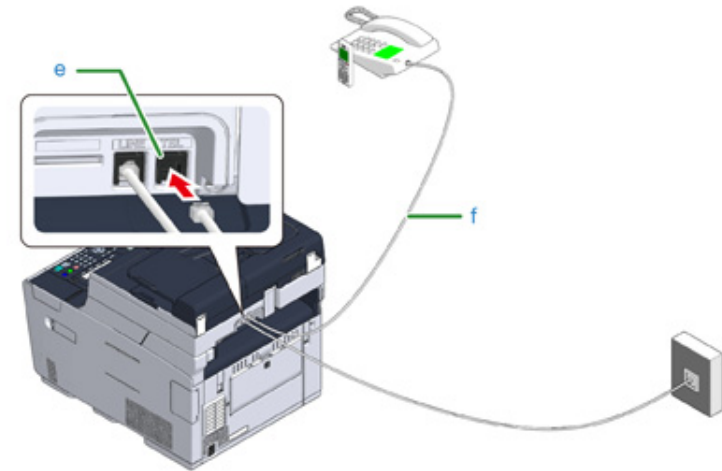



- Only one telephone can be connected to the machine.
- Do not connect the telephone to the machine in parallel. If you connect the telephone to the machine in parallel, the following problems occur, resulting in the machine not functioning correctly.
 - If you pick up the handset of the telephone that is connected in parallel while the machine is sending or receiving a fax, the fax image may be corrupted or a communication error may occur.
 - If the incoming call is a voice call, the telephone may ring late or stop halfway, and if the incoming call is a fax, the machine may not be able to receive the fax.

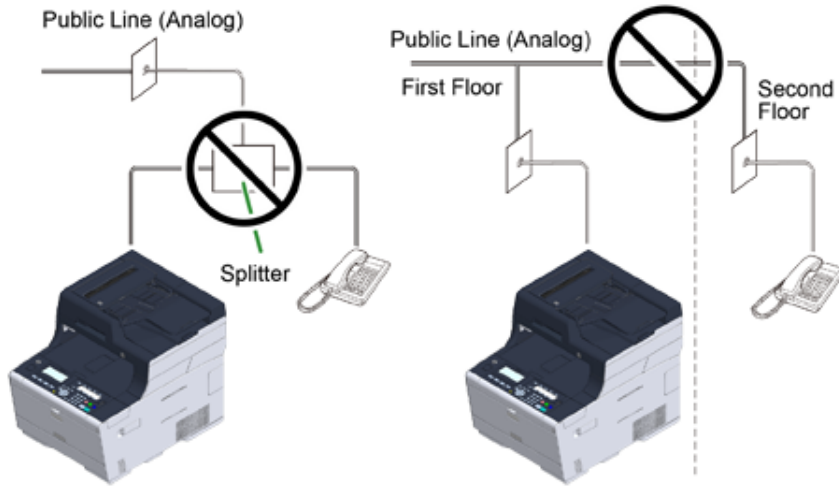

- If you connect a telephone with the fax function, disable the fax function of the telephone (disable fax reception) before using.



In the case of direct interconnection, separate construction work is required. Contact your telephone company.

Connecting the Optical IP telephone

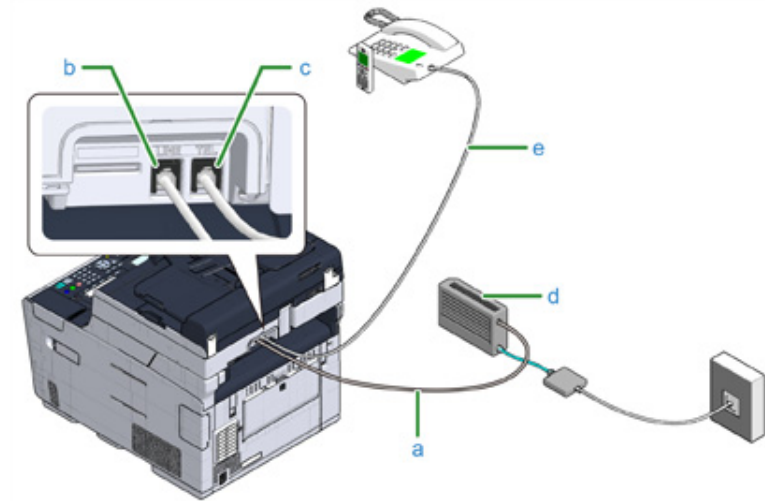

- 1 Plug the included telephone cable (a) that is connected to the Optical device (IP telephone) (d) into the LINE connector (b) of the machine.
- 2 Remove the telephone connector cover.
- 3 Plug the telephone cable (e) that is connected to an external telephone into the TEL connector (c) of the machine.



- If a fax dial fails, set the PBX line to [ON].
 - 🔗 User Install (Advanced Manual)
- If a fax transmission or reception fails, set [Super G3] to [OFF].
 - 🔗 User Install (Advanced Manual)

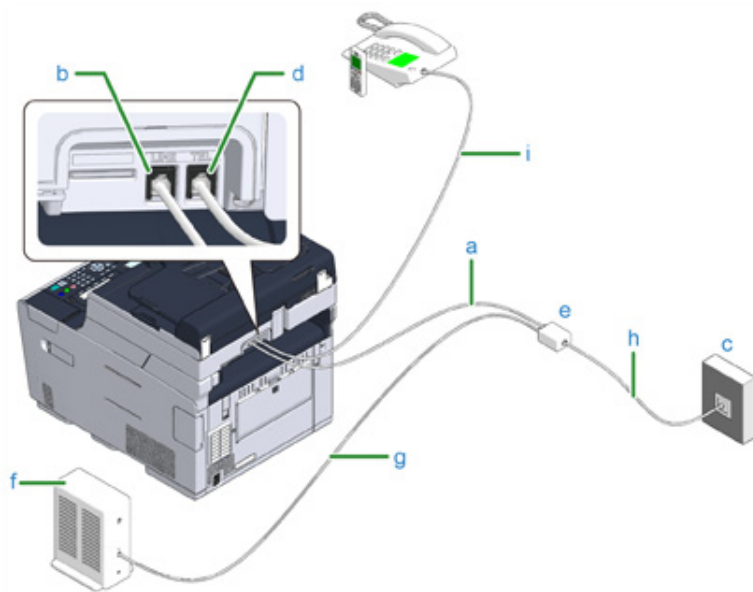

Connecting to the ADSL Environment

Besides the included telephone cable, a telephone cable of the same type is needed.



- 1 Plug one end of the included telephone cable (a) into the LINE connector (b) of the machine and the other end into a phone line splitter (e).
If you use a phone-line-splitter-built-in type ADSL modem, plug the included telephone cable (a) that is connected to the ADSL modem (f) into the LINE connector (b) of the machine.
- 2 Connect the phone line splitter (e) to the ADSL modem (f) with a telephone cable (g), and then plug another telephone cable (h) into the public line (analog) (c).
- 3 Remove the telephone connector cover.
- 4 Plug the telephone cable (i) that is connected to an external telephone into the TEL connector (d) of the machine.



- If a fax dial fails, set the PBX line to [ON].
 [User Install \(Advanced Manual\)](#)
- If a fax transmission or reception fails, set [Super G3] to [OFF].
 [User Install \(Advanced Manual\)](#)

Connecting PBX, Home Telephone or Business Phone

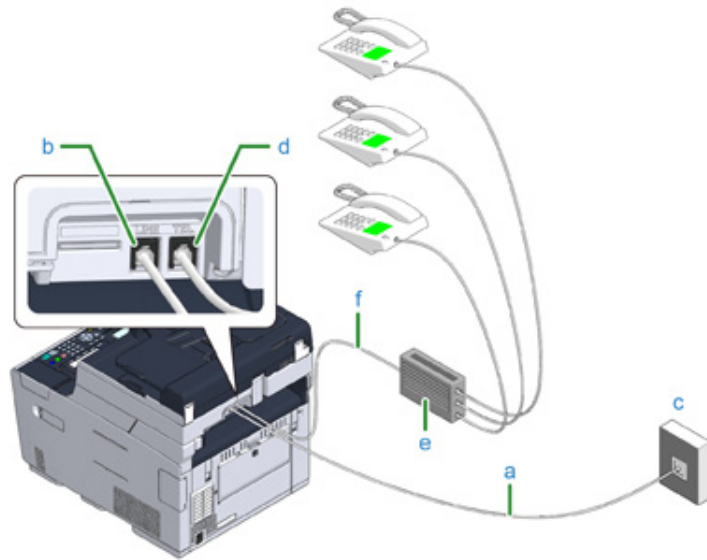

- 1 Plug the included telephone cable (a) that is connected to the public line (analog) (c) into the LINE connector (b) of the machine.
- 2 Plug the telephone cable (f) that is connected to a control device such as PBX (e) into the TEL connector (d) of the machine.



- Home Telephone is a simple switcher for home use, which connects multiple telephones with one or two telephone lines, enabling you to use extension and door phones.
- Business Phone is a simple switcher, which accommodates three or more telephone lines, with which many telephones can be shared, allowing for extension phones or other usage.

Connecting as an Extension Telephone

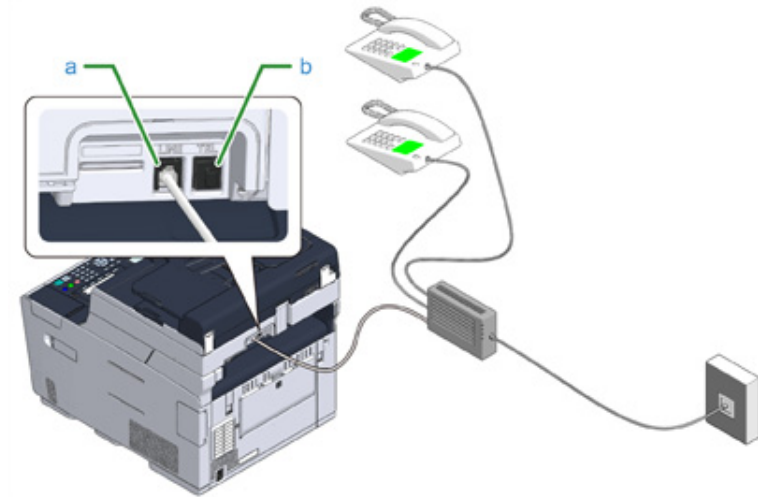

- 1 Plug the telephone cable that is connected to a control device such as PBX into the LINE connector (a) of the machine.
- 2 If you use a telephone line for both fax and phone, plug the telephone cable of the external telephone into the TEL connector (b).



If you connect to a PBX (private branch exchange), set the PBX line to [ON].

Fax Setup (Advanced Manual)

Connecting a CS Tuner or Digital Television

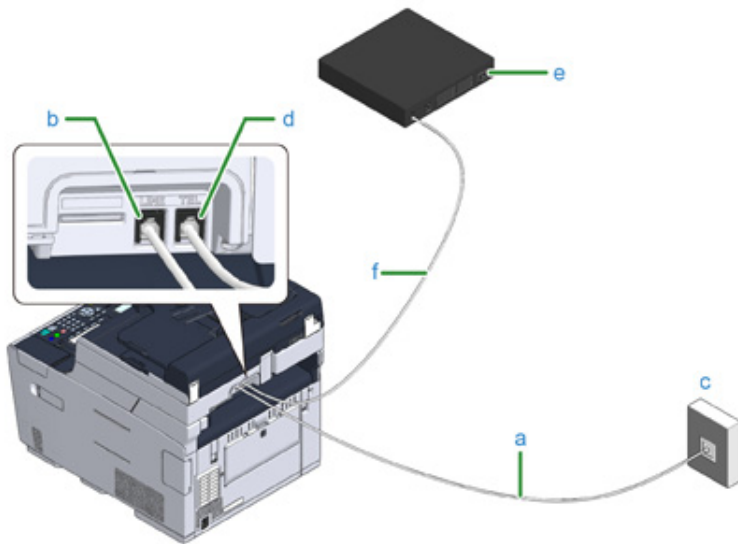

- 1 Plug the included telephone cable (a) that is connected to the public line (analog) (c) into the LINE connector (b) of the machine
- 2 Remove the telephone connector cover.
- 3 Plug the telephone cable (f) that is connected to the CS tuner or digital television (e) into the TEL connector (d) of the machine.

Connecting the Power Code

The power supply must meet the following conditions.

AC: 110 to 127V AC (Range 99 to 140V AC) / 220 to 240V AC (Range 198 to 264V AC)

Frequency: 50/60 Hz \pm 2%



- If the power supply is unstable, use a voltage regulator.
- The maximum power consumption of the machine is 1270 W. Check that the power supply is sufficient.
- The operation that uses an uninterruptible power supply (UPS) or inverter is not guaranteed. Do not use an uninterruptible power supply (UPS) or inverter.



WARNING

Fire or electric shock may result.



- Be sure to turn this machine off before connecting and disconnecting the power cord and the ground wire.
- Be sure to connect the ground wire to the designated ground terminal. If this machine cannot be grounded, contact your dealer.
- Be sure not to connect the ground wire to the ground of a water pipe, gas pipe or telephone line, or to a lightning rod.
- Be sure to connect the ground wire before connecting the power cord to the outlet. Also, be sure to unplug the power cord from the outlet before disconnecting the ground wire.
- Be sure to plug or unplug the power cord by holding its power plug.
- Securely plug the power cord into the outlet.
- Do not plug or unplug the power cord with wet hands.
- Install the power cord in a location where users cannot step on it, and do not place any object on the power cord.
- Do not bundle or tie the power cord.
- Do not use a damaged power cord.
- Do not overload the outlet.
- Do not connect the power cords of this machine and other electric products to the same outlet. If the power cord of this machine is connected to the same outlet as other electric products, especially an air conditioning machine, copier, or shredder, this machine may malfunction due to electrical noise. If you have to connect the power cord of this machine to the same outlet as other products, use a commercially available noise filter or noise cut transformer.
- Use the power cord included in this machine, and plug the cord directly into the outlet. Do not use the power cords of other products for this machine.
- Do not use an extension cord. If you have to use an extension cord, use a cord rated 15A or higher.
- Use of an extension cord may result in this machine malfunctioning due to AC voltage drop.
- Do not turn this machine off or unplug the power cord during printing.
- If you do not use this machine for an extended period of time due to holidays, trips, or other reasons, unplug the power cord.
- Do not use the power cord included in this machine for other products.

1 Plug the power cord into the power connector.



2 Plug the power cord into the outlet.

Connecting a LAN Cable/USB Cable

When using the machine in a wired network connection or connecting to a computer via a USB cable, connect the cable in the following steps.

- [Connecting a LAN Cable](#)
- [Connecting a USB Cable](#)

Connecting a LAN Cable



A LAN cable (category 5e or higher, twist pair, straight) is not supplied.

- 1 Prepare a LAN cable (category 5e or higher, twist pair, straight) and hub.

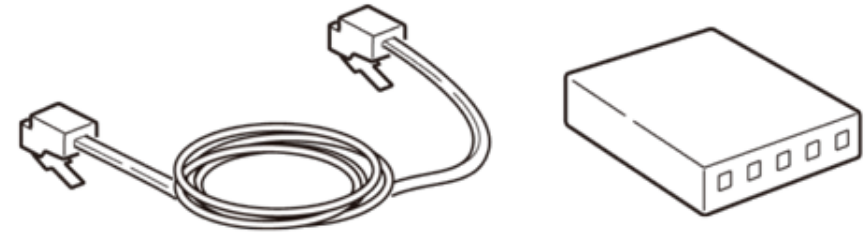

- 2 Check that the machine and computer are turned off.
- 3 Open the interface cover on the back side of the machine pressing the center part of it.



4 Insert one end of the LAN cable into the network interface connector.

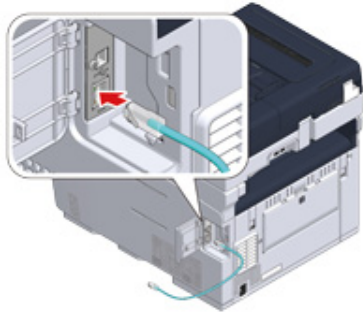

5 Pass the LAN cable under the tab, and then close the interface cover.

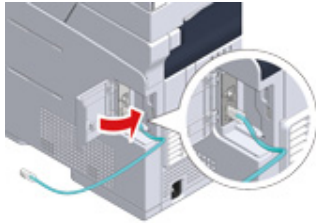

6 Insert the other end of the LAN cable into the hub.

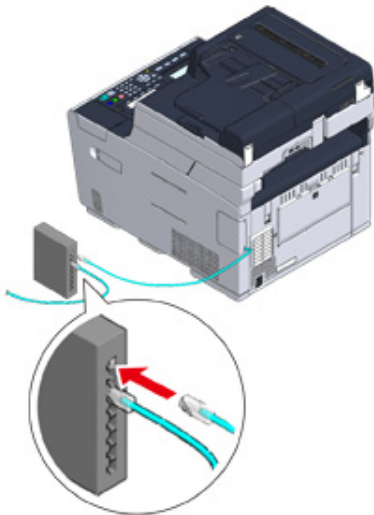

Go to the procedure to "[Loading Paper in the Tray](#)".

Connecting a USB Cable

A USB cable (Hi-Speed USB 2.0) is not supplied.

- 1 Prepare a USB cable.



If you want to connect in USB 2.0 Hi-Speed mode, use a Hi-Speed USB 2.0 USB cable.



- 2 Check that the machine and computer are turned off.
- 3 Open the interface cover on the back side of the machine pressing the center part of it.



- 4 Insert one end of the USB cable into the USB interface connector on the machine.



Do not insert the USB cable into the network interface connector. It may cause a malfunction.

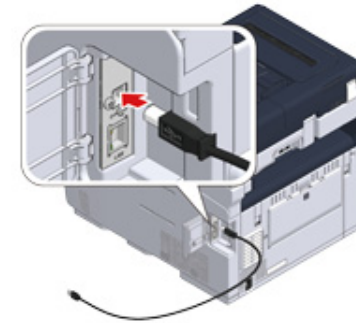

- 5 Pass the USB cable under the tab, and then close the interface cover.

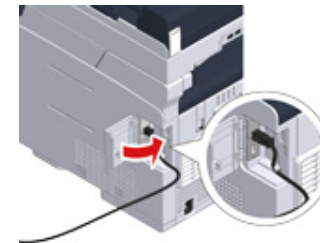

- 6 Insert the other end of the USB cable into the USB interface connector on the computer.



For Windows, do not insert the other end of the USB cable into the computer until the instruction is displayed on the screen when the driver installation is in progress.

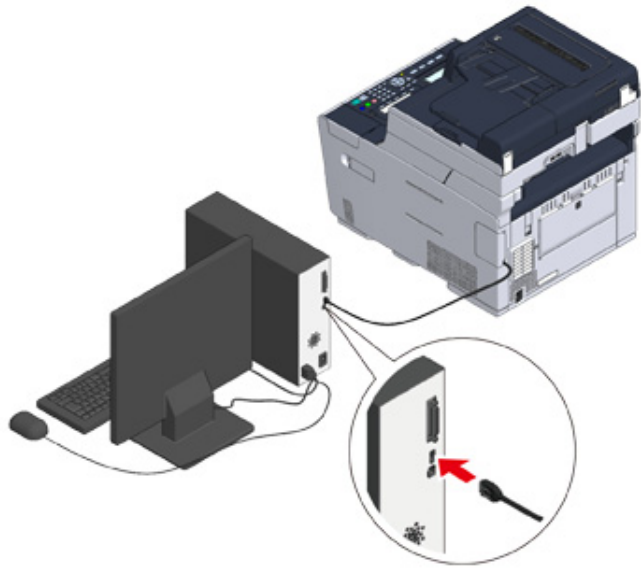

Go to the procedure to "[Loading Paper in the Tray](#)".

Loading Paper in the Tray

The procedure when loading paper in Tray 1 is used as an example.

The same procedure applies to Tray 2/3 (optional).

For details on available paper, see "[About Paper Types That Can be Loaded](#)".

- 1 Pull the paper cassette out.



- 2 Slide the paper guide (a) to the width of paper to be loaded.

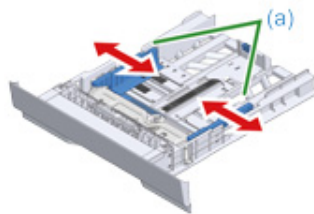

- 3 Slide the paper stopper (b) to the length of paper to be loaded.

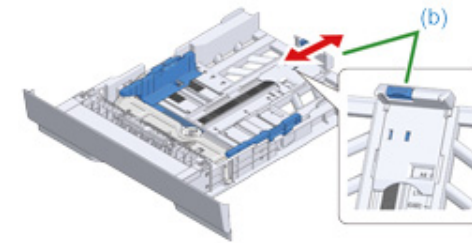

- 4 Fan a stack of paper well, and then align the edges of the paper.

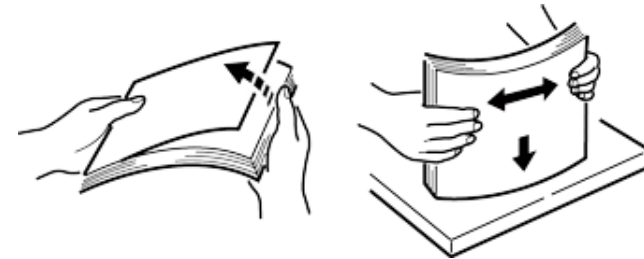

- 5 Load paper with the print side face down.



Do not load paper above the "▽" mark on the paper guide.

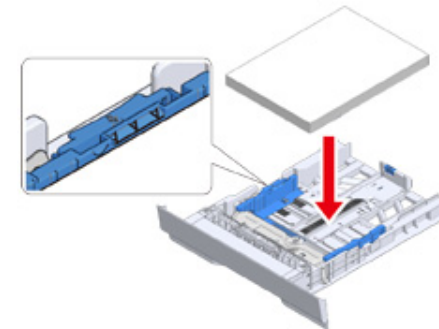

- 6 Secure the loaded paper with the paper guide.

- 7 Replace the paper cassette into the machine.
Push the paper cassette until it stops.



Checking the Setting Information

• Fax Setting

To use the fax function, the following information is needed.

Item	Description	Setting Value
Fax Number	Set the fax number of this machine. You can enter up to 20 digits.	
Sender ID	Set the sender's information. You can enter up to 22 characters.	

• Network Setting

To connect the machine to a network using a LAN cable, the following information is needed.

Item	Description	Setting Value
IP Address	Set the IP address of the machine.	
Subnet Mask	Set a subnet mask.	
Default Gateway	Set a gateway address.	
DNS Server (Primary)	Set the IP address for a Primary DNS server.	
DNS Server (Secondary)	Set the IP address for a Secondary DNS server.	
WINS Server (Primary)	Set the name (up to 15 characters) or the IP address for the Primary WINS server.	
WINS Server (Secondary)	Set the name (up to 15 characters) or the IP address for the Secondary WINS server.	

• E-mail Setting

To use functions which require sending and receiving E-mail such as the Scan To E-mail and Internet Fax functions, the following information is needed.

Item	Description	Setting Value
Mail Server Address	Set the IP address or host name for the SMTP server. You can enter up to 64 characters.	
Set Sender's Address (From)	It appears when sending E-mail.	
Receive Setting	Set [POP3], [SMTP], or [Disable]. If [POP3] is selected, check the POP3 server address.	
Authentication Method	Set [No Authentication], [SMTP Auth], or [POP Before SMTP]. If [SMTP Auth] or [POP Before SMTP] is selected, check the user name and password.	
(SMTP-Auth / POP Before SMTP) Authentication Method: User Name	Set a user name for authentication. Up to 64 characters can be registered.	

Item	Description	Setting Value
(SMTP Auth / POP Before SMTP) Authentication Method: Password	Set a password for authentication. Up to 64 characters can be registered.	

Setting Up This Machine

The first time the machine is turned on or when the settings are initialized, set up the machine with the necessary information.

The factory default display language is English and administration password is "999999".

















To change the display language and administration password, follow the procedure below.

It is recommended to change the administrator password to enhance security. Set the administrator password using from 6 to 12 alphanumeric characters.

Be careful not to forget the set password.













-
- [Language Setup](#)
 - [Setting the Administrator Password](#)
 - [Easy Setup](#)
-

Language Setup

- 1 Press the  (SETTING) button.
- 2 Press the  button to select [Admin Setup] and press the  button.
- 3 Enter the administrator password, and then press the  (OK) button.
The factory default administrator password is "999999".
- 4 Press the  or  button repeatedly to select [Manage Unit] and press the  button.
- 5 If you do not want to change the display language, go to step 5 in "[Setting the Administrator Password](#)".
To change the display language, press the  or  button repeatedly to select [Language Maintenance Setup] and press the  button.
- 6 Check that [Select Language] is selected, and then press the  button.
- 7 Press the  or  button repeatedly to select language you want to use and press the  (OK) button.
- 8 To set the administrator password, press the  (Back) button once and go to step 5 in "[Setting the Administrator Password](#)".
If you want to set the administrator password later, press the  (Back) button repeatedly until the top screen is displayed.























Setting the Administrator Password

Set the administrator password using from 6 to 12 alphanumeric characters. Be careful not to forget the set password.

- 1 Press the  (SETTING) button.
- 2 Press the  button to select [Admin Setup] and press the  button.
- 3 Enter the administrator password, and then press the  (OK) button.
The factory default administrator password is "999999".
- 4 Press the  or  button repeatedly to select [Manage Unit] and press the  button.
- 5 Press the  or  button to select [Admin Password] and press the  button.
- 6 Enter a new password, and then press the  (OK) button.
- 7 Enter the password again to confirm, and then press the  (OK) button.
- 8 Press the  (Back) button until the top screen is displayed.

Easy Setup

Set up the date and time, fax function, network, and E-mail. You can skip unnecessary settings.

- 1 Check that the wiring has correctly been finished.
- 2 Press the  (SETTING) button.
- 3 Press the  or  button repeatedly to select [Easy Setup] and press the  button.
- 4 Enter the administrator password, and then press the  (OK) button.

The factory default administrator password is "999999". If the administrator password is changed, enter the updated password.
- 5 Check that [1. Date/Time Setting] is selected, and then press the  button.
- 6 Press the  or  button to select the Time Zone you want to set and press the  button.
- 7 When the daylight saving setting screen is displayed, press the  or  button to select a setting suitable to your environment and press the  button.
- 8 Check that [Manual] is selected on the [Please select way to set Day and Time] screen, and then press the  button.
- 9 Press the  or  button to set [Day] and press the  button. Press the  or  button to set [Month] when the cursor has moved, and then press the  button. Press the  or  button to set [Year] and press the  (OK) button.
- 10 Set the time in the same manner.
- 11 [Date/Time Setting was completed] is displayed for several seconds and the screen returns to the [Setup Menu] screen.

- 12** To set up the fax function, press the ▼ button to select [2. Fax Setting] and press the ► button.
If you do not want to use the fax function, go to step 16.
- 13** Check that [Fax Number] is displayed, and then press the ► button. Enter the fax number using the numeric keypad, and then press the Ⓞ (OK) button.
- 14** Check that [Sender ID] is displayed, and then press the ► button. Enter the SenderID using the keyboard and numeric keypad and press the Ⓞ (OK) button.
- 15** [Fax Setting was completed] is displayed for several seconds and the screen returns to the [Setup Menu] screen.
- 16** To set up the wired network connection, press the ▼ button repeatedly to select [3. Network Setting] and press the ► button.
If you do not want to use the wired network connection, go to step 19.
- 17** Check that [Auto] is selected, and then press the ► button.
-  When setting manually, check the following values specified by your provider or network administrator.
IP address, subnet mask, default gateway,
DNS Server (Primary), DNS Server (Secondary),
WINS Server (Primary), WINS Server (Secondary)
- 18** [Network Setting was completed] is displayed for several seconds and the screen returns to the [Setup Menu] screen.
- 19** To set up the Scan To E-mail function, press the ▼ button repeatedly to select [4. E-mail Setting] and press the ► button.
If you do not want to use the E-mail function, go to step 24.
- 20** Check that [Please set Address of Mail Server] is displayed, and then press the ► button.
- 21** Enter the mail server address and press the Ⓞ (OK) button.
- 22** Set also the SMTP Port, SMTP Encryption, Sender's Address(From), Receive Setting, Authentication Method, SMTP User ID, SMTP Password, POP3 Server, POP User ID, POP Password.
- 23** [E-mail Setting was completed] is displayed for several seconds and the screen returns to the [Setup Menu] screen.
- 24** Press the ◀ button to save the settings.
- 25** Check that [Yes] is selected on the [Would you like to save?] screen, and then press the Ⓞ (OK) button.
- 26** Press the ◀ button until the top screen is displayed.

Connecting to a Wireless LAN (Only When the Wireless LAN Module is Mounted)

- [Before Connecting to a Wireless LAN](#)
- [Enabling Wireless LAN Connection](#)
- [Connecting to an Access Point \(Infrastructure\)](#)
- [Connecting to the Machine Directly](#)

Before Connecting to a Wireless LAN



- Wireless(Infrastructure) and Wireless(AP Mode) cannot be enabled at the same time.
- If the machine is used in a wireless network environment, the machine does not enter Deep Sleep mode but enters Sleep mode.
- Do not place any electric products that emit weak radio waves (such as microwaves or digital cordless telephones) close to the machine.
- The communication speed of a wireless LAN connection may be slower than that of a wired LAN or USB connection depending on the environment. If you want to print big data such as a photo, it is recommended to print with a wired LAN or USB connection.

Connecting to an Access Point

Before connecting this machine to a wireless LAN access point, check the following.



- 1 Check if your wireless LAN access point matches the following requirements.
Standards: IEEE 802.11 a/b/g/n
Access method: Infrastructure mode
- 2 Check if the wireless LAN access point supports WPS.
If it does not support WPS, check the SSID and encryption key by referring to the instruction manual that is included in the wireless LAN access point or other documents.



- An SSID is also called a network name, ESSID or ESS-ID.
- An encryption key is also called a network key, security key, password, or Pre-shared Key.

Connecting to the Machine Directly

You can use the machine as a wireless access point to directly connect wireless devices (computers, tablets, smartphones, etc.). Check the following.

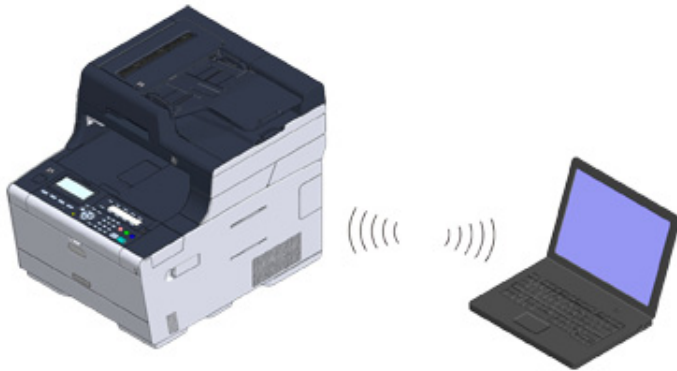













- 1 Check if your wireless devices match the following requirements.
Standards: IEEE 802.11 b/g/n
Security: WPA2-PSK(AES)
- 2 Check if your wireless devices support WPS-PBC (push button).



If you are not sure that the device supports WPS-PBC, connect manually after turning the machine on.

Enabling Wireless LAN Connection

After attaching the wireless module, enable the wireless LAN module on the operator panel.

- 1 Press the  (SETTING) button.
- 2 Press the  button to select [Admin Setup] and press the  button.
- 3 Enter the administrator password, and then press the  (OK) button.
The factory default administrator password is "999999". If the administrator password is changed, enter the updated password.
- 4 Press the  or  button repeatedly to select [User Install] and press the  button.
- 5 Press the  or  button repeatedly to select [Wireless Module] and press the  button.
- 6 Check that [Enable] is selected, and then press the  (OK) button.
- 7 Press the  button until the home screen is displayed.
- 8 Press the power button to turn the machine off.

Go to "[Connecting to an Access Point \(Infrastructure\)](#)".

Connecting to an Access Point (Infrastructure)



- Install this machine in a place with a good view and near a wireless access point. (We suggest that the distance between the machine and the wireless device be 30 m or less.)
- If there is metal, aluminum sash, or a reinforced concrete wall between the machine and wireless LAN access points, connections may be harder to be established.
- Outdoor use of IEEE802.11a (W52/W53) is prohibited by the Radio Law. Use IEEE802.11a (W52/W53) only indoors.

• Connecting with WPS

If a wireless LAN access point supports WPS, you can connect to the wireless LAN with the WPS button.

• Selecting a Wireless LAN Access Point from the Operator Panel to Connect

If a wireless access point does not support WPS, you can specify a wireless LAN access point you want to use from the wireless LAN access points that the printer detects to establish a connection.

• Setting from the Operator Panel Manually to Connect

Set the wireless LAN access point information (the SSID, encryption method, and encryption key) manually to connect to the wireless LAN.

Connecting with WPS



If a wireless LAN access point supports WPS, you can easily connect to the wireless LAN with the easy setup button (WPS button).

- 1 Check the position of the WPS button by referring to the instruction manual that is included in a wireless LAN access point or other document.
- 2 Check that the wireless LAN access point starts and is operating properly.
- 3 Turn the machine on.



Check that the screen displays "Do you want to Set-up wireless?" and [Yes] is selected, Press the  (OK) button and go to step 6.

- 4 Press the  (SETTING) button.



- 5 Press the  or  button repeatedly to select [Wireless(Infrastructure) Setting] and press the  button.

- 6 Enter the administrator password on the administrator password entry screen, and then press the  (OK) button.

The factory default administrator password is "999999". If the administrator password is changed, enter the updated password.



- 7 Check that the screen displays the "Cannot be used simultaneously with wireless (AP Mode)." message for several seconds and [Enable] is selected on the [Please enable/disable wireless (infrastructure)] screen. Press the  (OK) button.

- 8 If your environment requires to set IP address, etc. manually, check [Network Setting] is selected and press the  button. If you do not need to set manually, go to step 12.

- 9 Press the  button to select [Manual] and press the  button.

- 10 Follow the onscreen instructions to set the IP address, subnet mask, default gateway, and DHCP v6.

- 11 When the setup is complete, press the  (OK) button.

- 12 Press the  button once to select [Automatic Setup(WPS)] and press the  button.

- 13 Check that [WPS-PBC] is selected, and then press the  button.

- 14 Check that [Yes] is selected on the [Execute push-button method?] screen, and then press the  (OK) button.

The machine starts searching for wireless LAN access points. When the screen displays the "Running pushbutton method..." message, press and hold the WPS button on the wireless LAN access point for several seconds.



You cannot operate the panel when WPS is in progress.

When the "WPS connection successful." message appears on the screen, the setting of the wireless LAN is complete.



- If the "Connection failed. Timeout" message appears, repeat the procedure from step 8.
- [Overlap] is displayed when multiple WPS push buttons are pressed almost at the same time at two or more wireless LAN access points and connection is not established. Wait for a while, and then try again.

15 If the antenna mark is displayed at the top right of the home screen, the connection is established correctly.



The antenna mark may not be displayed on some screens such as the copy top screen.

Selecting a Wireless LAN Access Point from the Operator Panel to Connect

If a wireless LAN access point does not support WPS, you can specify a wireless LAN access point you want to use from the wireless LAN access points that the machine detects to establish a connection. In such a case, you must enter an encryption key.

1 Check the SSID and encryption key by referring to the instruction manual that is included in a wireless LAN access point or other documents, and write the information down.



WPA-EAP and WPA2-EAP cannot be set on the operator panel. Set them from the Web page of this machine.

Open the Web Page of This Machine (Advanced Manual)



- An SSID is also called a network name, ESSID or ESS-ID.
- An encryption key is also called a network key, security key, password or Pre-shared Key.

2 Check that the wireless LAN access point starts and is operating properly.

3 Turn the machine on.



Check that the screen displays "Do you want to Set-up wireless?" and [Yes] is selected, Press the (OK) button and go to step 6.

4 Press the (SETTING) button.

5 Press the or button repeatedly to select [Wireless(Infrastructure) Setting] and press the button.

6 Enter the administrator password on the administrator password entry screen, and then press the (OK) button.

The factory default administrator password is "999999". If the administrator password is changed, enter the updated password.

7 Check that the screen displays the "Cannot be used simultaneously with wireless (AP Mode)." message for several seconds and [Enable] is selected on the [Please enable/disable wireless (infrastructure)] screen. Press the (OK) button.

8 If your environment requires to set IP address, etc. manually, check [Network Setting] is selected and press the button. If you do not need to set manually, go to step 12.

9 Press the button to select [Manual] and press the button.

10 Follow the onscreen instructions to set the IP address, subnet mask, default gateway, and DHCP v6.

11 When the setup is complete, press the (OK) button.

12 Press the button repeatedly to select [Wireless Network Selection] and press the button.

The machine starts searching for wireless LAN access points. Wait for a while.

13 When wireless LAN access points are displayed, press the or button to select a wireless LAN access point, and then press the button.



If only [Manual Setup] is displayed, or the SSID of the wireless LAN access point you want to use is not included in the list, set by following the procedure in "[Setting from the Operator Panel Manually to Connect](#)".

The encryption key entry screen that is suitable for the encryption method of the selected wireless LAN access point is displayed.

14 Enter the encryption key that you checked in step 1, and then press [OK].



The encryption key varies depending on the wireless LAN access point or security.

- If the [WPA Pre-shared Key] is displayed

Item	Description
Security	WPA/WPA2-PSK
Encryption key	Enter the Pre-shared Key.

- If [WEP Key] is displayed

Item	Description
Security	WEP
Encryption key	Enter the WEP key.

- If neither of the above two cases is applied

Item	Description
Security	Disable
Encryption key	No entry is required.

- 15** If the displayed SSID is the same as the SSID that you checked in step 1, press [Yes].

When "Connection successful." is displayed, press [Close].

If "Connection failed." is displayed, repeat the procedure from step 7.

- 16** If the antenna mark is displayed at the top right of the display screen, the connection is established correctly.



The antenna mark may not be displayed on some screens such as the copy top screen.

Setting from the Operator Panel Manually to Connect

Set the wireless LAN access point information (the SSID, encryption method and encryption key) manually to connect to the wireless LAN.

- 1** Check the SSID, encryption key, and security by referring to the instruction manual that is included in a wireless LAN access point or other documents, and write the information down.



If the encryption method is WPA-EAP and WPA2-EAP, set from the Web page of this machine.

For details, open the Web page of this machine and click [Admin Setup] > [Network] > [Wireless Setting] > [Manual Setup].

Open the Web Page of This Machine (Advanced Manual)



- An SSID is also called a network name, ESSID, or ESS-ID.
- An encryption key is also called a network key, security key, password, or Pre-shared Key.

- 2** Check that the wireless LAN access point starts and is operating properly.

- 3** Turn the machine on.



Check that the screen displays "Do you want to Set-up wireless?" and [Yes] is selected, and then press the (OK) button.

- 4** Press the (SETTING) button.

- 5** Press the or button repeatedly to select [Wireless(Infrastructure) Setting] and press the button.

- 6** Enter the administrator password on the administrator password entry screen, and then press the (OK) button.

The factory default administrator password is "999999". If the administrator password is changed, enter the updated password.



- 7** Check that the screen displays the "Cannot be used simultaneously with wireless (AP Mode)." message for several seconds and [Enable] is selected on the [Please enable/disable wireless (infrastructure)] screen. Press the (OK) button.

- 8** If your environment requires to set IP address, etc. manually, check [Network Setting] is selected and press the button. If you do not need to set manually, go to step 12.

- 9** Press the button to select [Manual] and press the button.





- 10** Follow the onscreen instructions to set the IP address, subnet mask, default gateway, and DHCP v6.

- 11** When the setup is complete, press the (OK) button.

- 12** Press the ▼ button repeatedly to select [Wireless Network Selection] and press the  (OK) button.
The machine starts searching for wireless LAN access points. Wait for a while.
- 13** Press the ▼ button to select [Manual Setup], and then press the ► button.
- 14** Check that the SSID entry screen is displayed and press the ► button. Use the ▲, ▼, ◀, or ▶ button to enter the SSID, select [Done] at the end, and then press the  (OK) button.
- 15** Select the encryption method that you checked in step 1, and then press the  (OK) button.



The encryption key varies depending on the wireless LAN access point or security.

- 16** The procedure depends on the encryption method you selected in step 15.
If you selected [WPA/WPA2-PSK], select [TKIP/AES], and then press the  (OK) button. Enter the Pre-shared Key, select [Done] at the end, and then press the  (OK) button.
If you selected [WPA2-PSK], select [AES], and then press the  (OK) button. Enter the Pre-shared Key, select [Done] at the end, and then press the  (OK) button.
If you selected [WEP], enter the WEP Key, and then press the  (OK) button.

- 17** If the displayed content is the same as that you checked in step 1, select [Yes] and then press the  (OK) button.



It takes approximately 30 seconds for the machine to detect the wireless LAN access point.

When the screen indicates that connection is established, press [OK].

If the screen indicates that connection failed, press [OK] and go back to step 5.

- 18** If the antenna mark is displayed at the top right of the home screen, the connection is established correctly.



The antenna mark may not be displayed on some screens such as the copy top screen.

- **If the wireless LAN connection is unstable**

If the wireless LAN connection is unstable, read the cautions in "[Before Connecting to a Wireless LAN](#)", and then change the positions of the machine and wireless LAN access point. If you cannot find a solution even after reading the cautions, bring the machine and the wireless LAN access point close to each other.

Connecting to the Machine Directly

Wireless LAN (AP mode) directly connects wireless devices (computers, tablets, smartphones, etc.) to the machine without using a wireless LAN access point.



- Up to four devices can be connected to the machine via the wireless LAN (AP mode).
- If there is metal, aluminum sash, or a reinforced concrete wall between the machine and wireless devices, connections may be harder to be established.

• Automatic connection (push-button)

If your wireless devices support WPS-PBC (push button), you can connect to the wireless LAN (AP mode) with the WPS button.

• Manual Setup

If your wireless devices do not support WPS-PBC (push button), you can enter [SSID] and [Password] of the machine in your wireless devices to connect to the wireless LAN (AP mode).

Automatic connection (push-button)

If your wireless devices support WPS-PBC (push button), you can connect to the wireless LAN (AP mode) with the WPS button.

1 Confirm the position of the WPS button on your wireless device by the manual attached to the device.

2 Turn the machine on.



If the "Do you want to Set-up wireless?" message appears, press the ▼ button to select [No (Do not show next time)], and then press the  (OK) button.

3 Press the  (SETTING) button.

4 Press the ▲ button once to select [Admin Setup] and press the ► button.

5 Enter the administrator password on the administrator password entry screen, and then press the  (OK) button.

The factory default administrator password is "999999". If the administrator password is changed, enter the updated password.

6 Press the ▼ or ▲ button repeatedly to select [Network Menu] and press the ► button.

7 Check that [Network Setting] is selected, and then press the ► button.

8 Press the ▼ button repeatedly to select [Wireless(AP Mode) Setting] and press the ► button.

9 Check that the screen displays the "Cannot be used simultaneously with wireless (infrastructure)." message for several seconds and [Enable] is selected on the [Please enable/disable wireless (AP mode)] screen. Press the  (OK) button.

10 Check that [Automatic connection (push-button)] is selected on the [Please set wireless (AP mode)] screen, and then press the ► button.

11 Check that [Yes] is selected on the [Would you like to run wireless (AP mode) automatic connection (push-button)?] screen, and then press the  (OK) button.

12 Start the WPS-PBC (push button) operation on your wireless device to connect to the machine.

When connection is established, the "Succeed running wireless (AP mode) automatic connection (push-button)." message is displayed on the screen.

If the message indicating that connection failed, press the  (OK) button, and follow the steps in "Manual Setup" to try again.

13 Press the ◀ button repeatedly until the top screen is displayed.



Manual Setup

If your wireless devices do not support WPS-PBC (push button), you can enter [SSID] and [Password] of the machine in your wireless devices to connect to the wireless LAN.

1 Turn the machine on.



If the "Do you want to Set-up wireless?" message appears, press the ▼ button to select [No (Do not show next time)], and then press the  (OK) button.

- 2 Press the  (SETTING) button.
- 3 Press the ▲ button once to select [Admin Setup] and press the ► button.
- 4 Enter the administrator password on the administrator password entry screen, and then press the  (OK) button.
The factory default administrator password is "999999". If the administrator password is changed, enter the updated password.
- 5 Press the ▼ or ▲ button repeatedly to select [Network Menu] and press the ► button.
- 6 Check that [Network Setting] is selected, and then press the ► button.
- 7 Press the ▼ button repeatedly to select [Wireless(AP Mode) Setting] and press the ► button.
- 8 Check that the screen displays the "Cannot be used simultaneously with wireless (infrastructure)." message for several seconds and [Enable] is selected on the [Please enable/disable wireless (AP mode)] screen. Press the  (OK) button.
- 9 Press the ▼ button to select [Manual Setup] on the [Please set wireless (AP mode)] screen, and then press the ► button.
- 10 Check the [SSID] and [Password] of the machine.
- 11 Enter the [SSID] and [Password] that you checked in step 10 to connect the machine and your wireless device.
- 12 Press the ◀ button repeatedly until the top screen is displayed.

Installing a Driver and Software to a Computer

Install the printer driver, scanner driver, fax driver, etc. from the "Software DVD-ROM" to the computer.

Other utility software can be installed at the same time.

- [For Windows](#)
- [For Mac OS X](#)

For Windows

Connect the machine and computer via a network or USB cable and start installing.



Check the status of this machine before installing.

- This machine is turned on.
- For network connection, this machine is connected to the network via a LAN cable and required information such as IP address is already set.

- 1 Insert the included "Software DVD-ROM" into a computer.
- 2 When [Auto Play] is displayed, click [Run setup.exe].

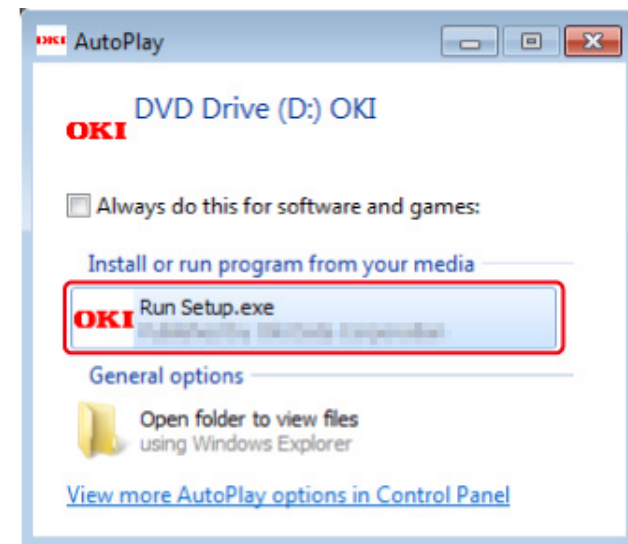

If the [User Account Control] dialog box is displayed, click [Yes].

- 3 Select a language from the drop-down list.
- 4 Read the license agreement, and then click [Accept].
- 5 Read [Environment advice], and then click [Next].

- 6 Select [Network] or [USB connection] in accordance to the connection method of the machine and computer, and then click [Next].

If the [Windows Security Alert] dialog box is displayed, click [Allow access].

- 7 Select the model name of the machine, and then click [Next].

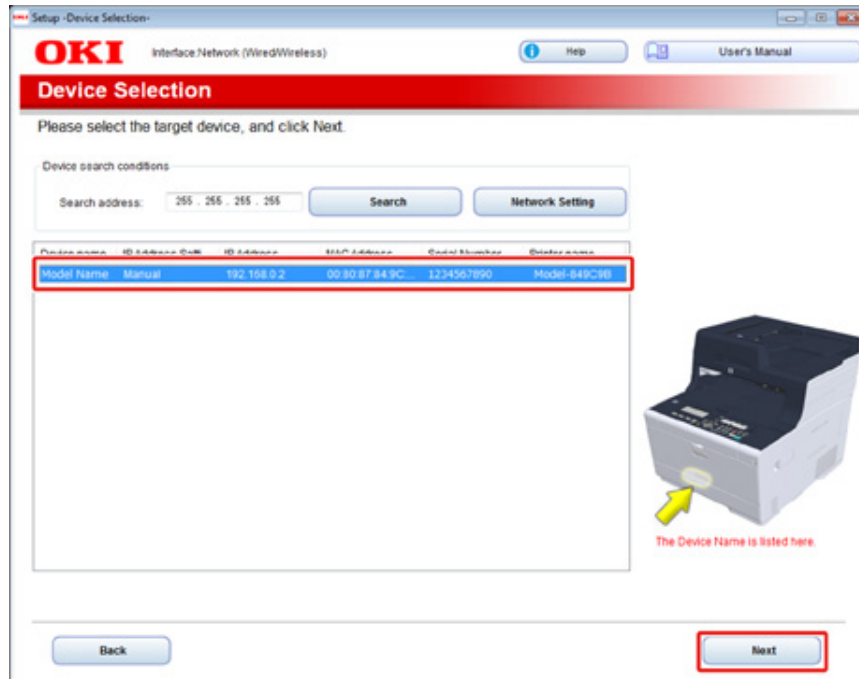

- 8 Click [Install Optional Software].

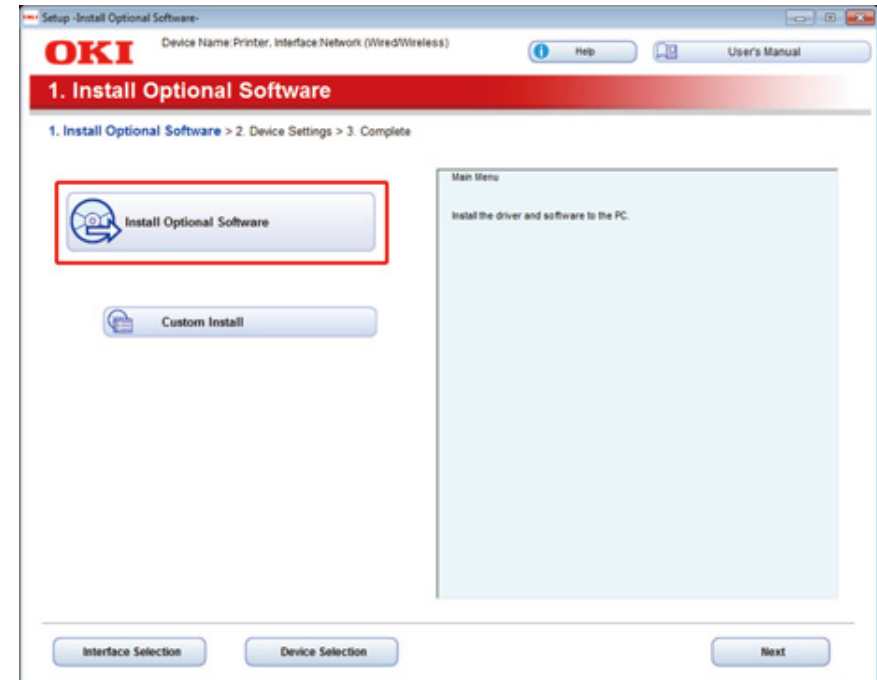

Installation starts.



The following software is installed.

- PCL6 Printer Driver (Including Network Extension and Color Swatch Utility)
- Scanner Driver
- ActKey
- FAQ

Install other software from Custom Install.

 [Installing Software \(Advanced Manual\)](#)

- 9 Make sure that the software is successfully installed, and then click [Printing Test].

Select the printer for test printing, and then click [Printing Test].

Make sure that the test printing was successful, and then click [OK].

10 Click [Complete].

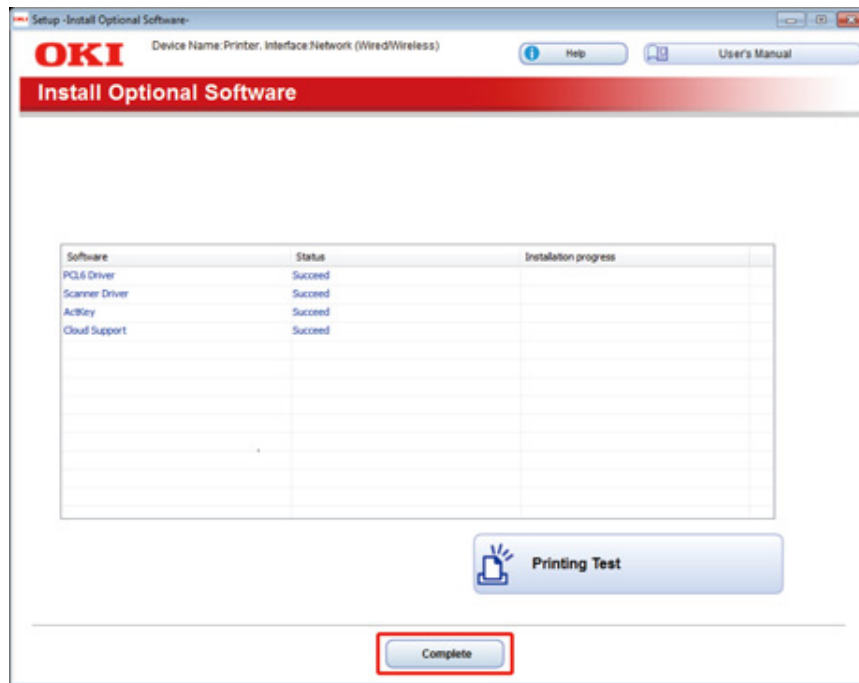

11 Click [Next].

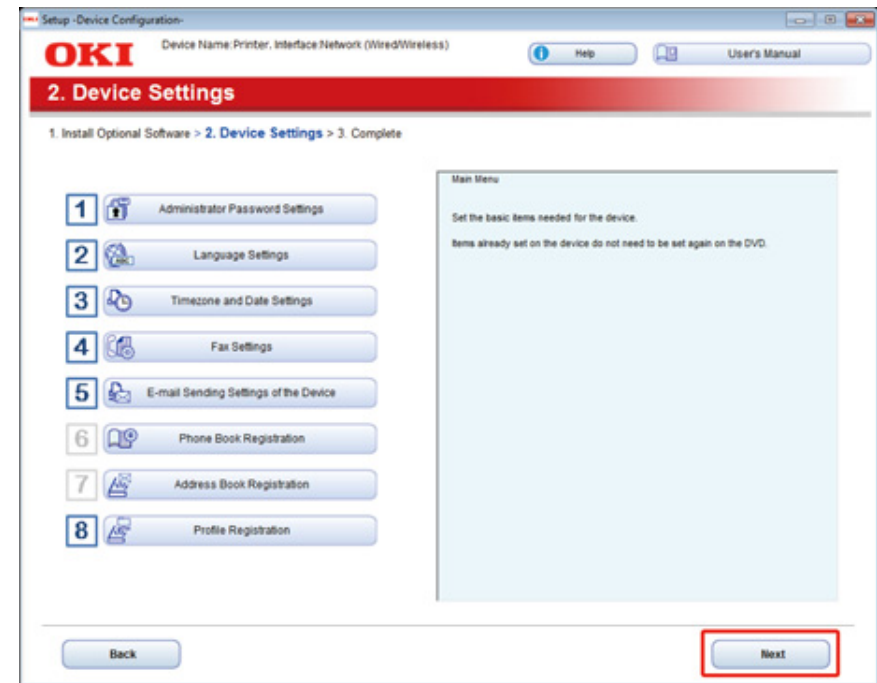

If the following dialog box is displayed, click [Yes].

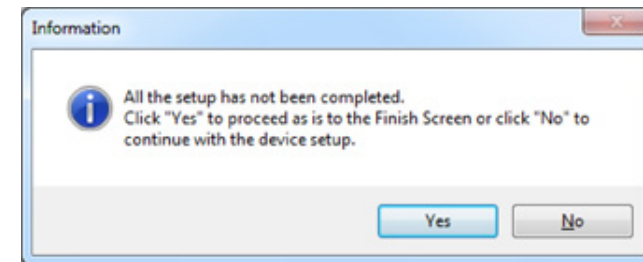

12 Click [Exit].

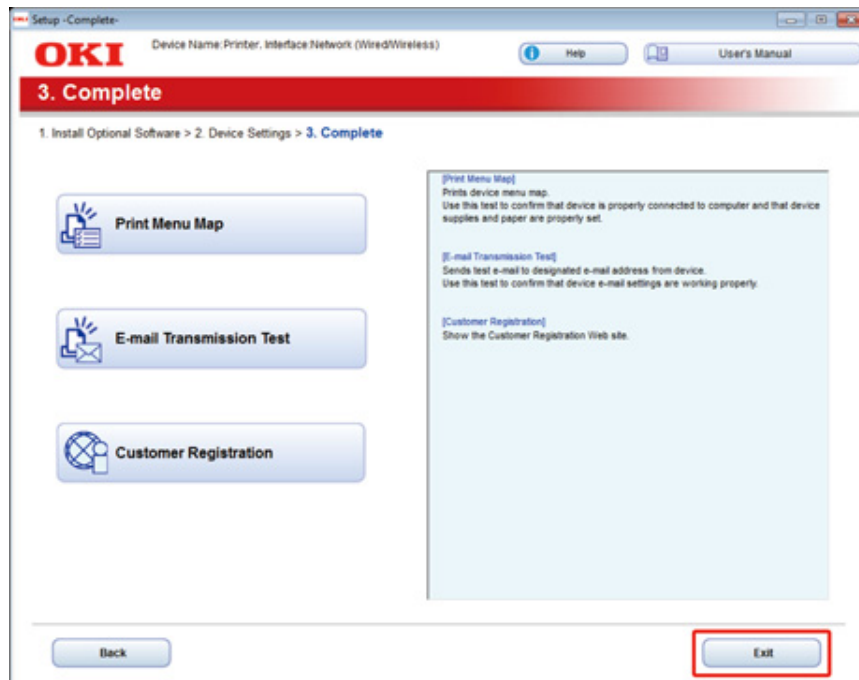

For Mac OS X

This section describes how to install the PS printer driver and scanner driver.

For installation of utilities, see the following.

 Installing Software (Advanced Manual)

• Install the Mac OS X scanner driver

- 1 Make sure that the machine and a computer are connected and the machine is turned on, and then insert the included "Software DVD-ROM" into the computer.
- 2 Double-click the [OKI] icon on the desktop.
- 3 [Drivers] > [Scanner] > Double-click [Installer for OSX].
- 4 Click [Continue].
- 5 Check that the displayed content, and then click [Continue].

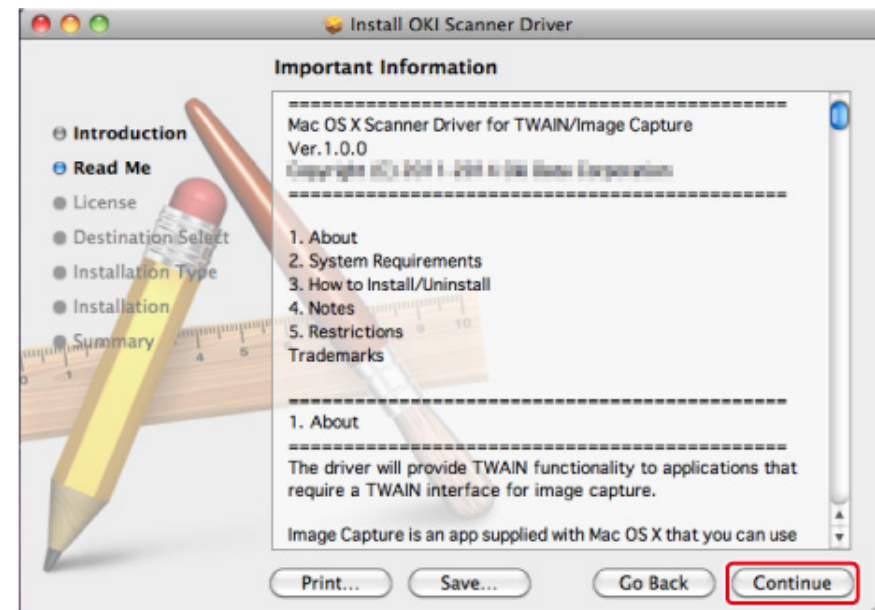

- 6 Read the license agreement, and then click [Continue].
- 7 Click [Agree].
- 8 Click [Install].
To change the driver installation location, click [Change Install Location].

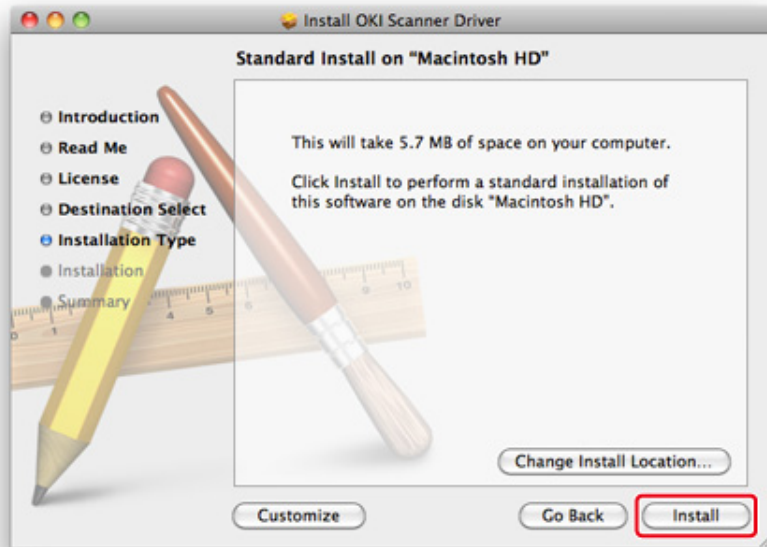

- 9 Enter the administrator name and password, and then click [Install Software].
- 10 Click [Continue Installation].

- 11 Click [Restart].

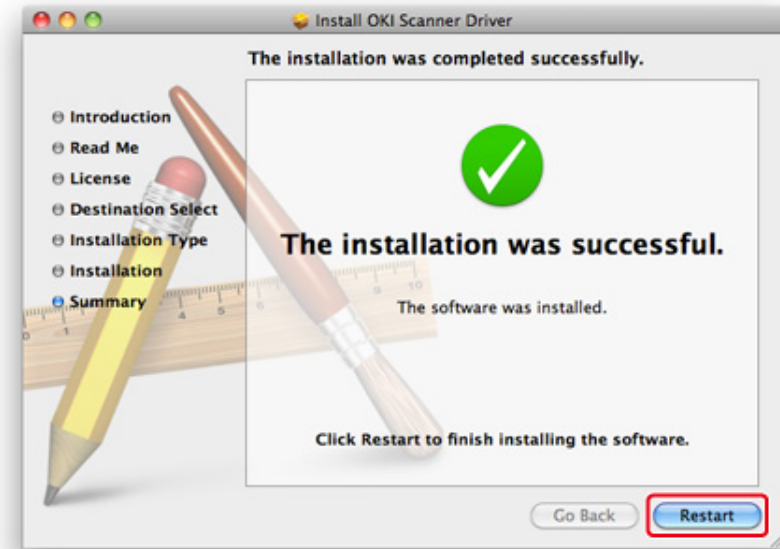

- **Install the Mac OS X PS printer driver**

When the installation is complete, print a test page in step 15.

- 1 Make sure that the machine and a computer are connected and the machine is turned on.
- 2 Insert the "Software DVD-ROM" into a computer.
- 3 Double-click the [OKI] icon on the desktop.
- 4 [Drivers] > [PS] > Double-click [Installer for OSX].
- 5 Enter the administrator password, and then click [OK].
Follow the on-screen instructions to complete the installation.
- 6 Select [System Preferences] from the Apple menu.
- 7 Click [Printers & Scanners].

- 8 Click [+].
Select [Add Printer or Scanner...] when the menu is displayed.

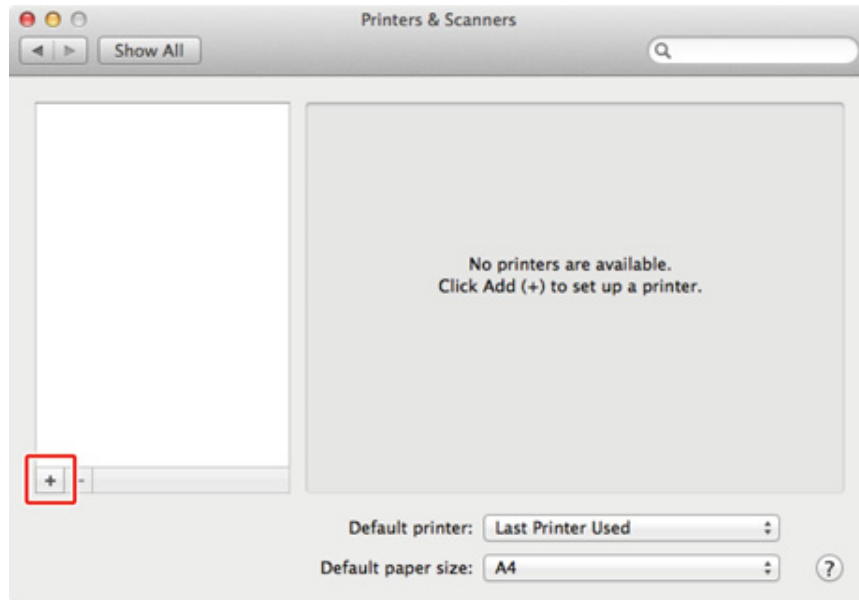

- 9 Click [Default].
- 10 Select the machine, and then make sure that [OKI MC563 PS] is displayed for [Use].

Types of Names	Displayed in the Connection	Methods List
Network	OKI-MC563 (last 6 digits of MAC address)	Bonjour
USB	OKI DATA CORP MC563	USB



To change the name, enter a new name into [Name:].

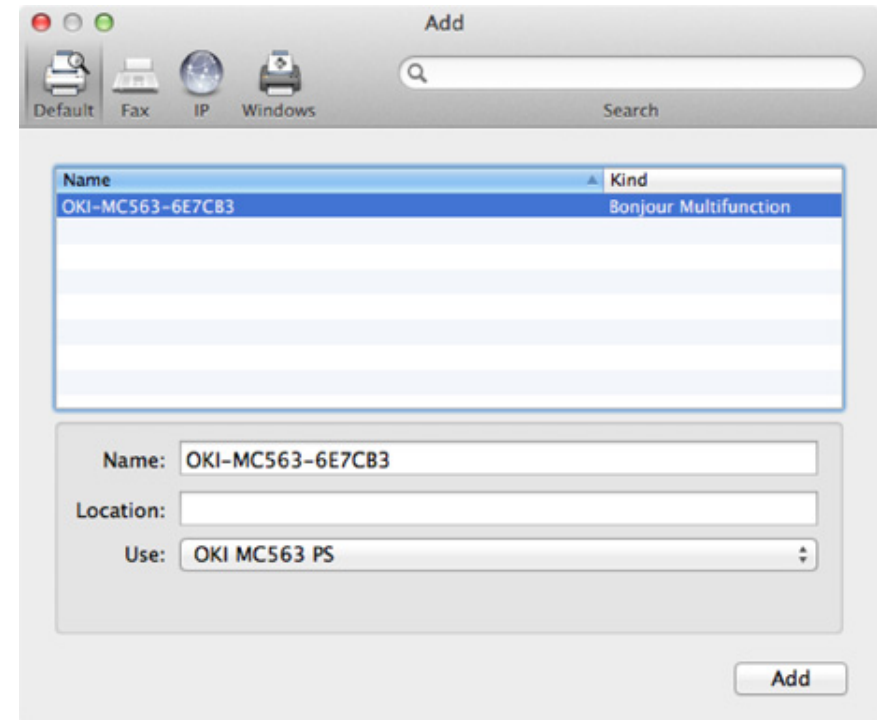

- 11 Click [Add].
- 12 If [Installable options] is displayed, click [Continue].

- 13 Make sure that the machine is added to [Printers] and [OKI MC563 PS] is displayed for [Kind].

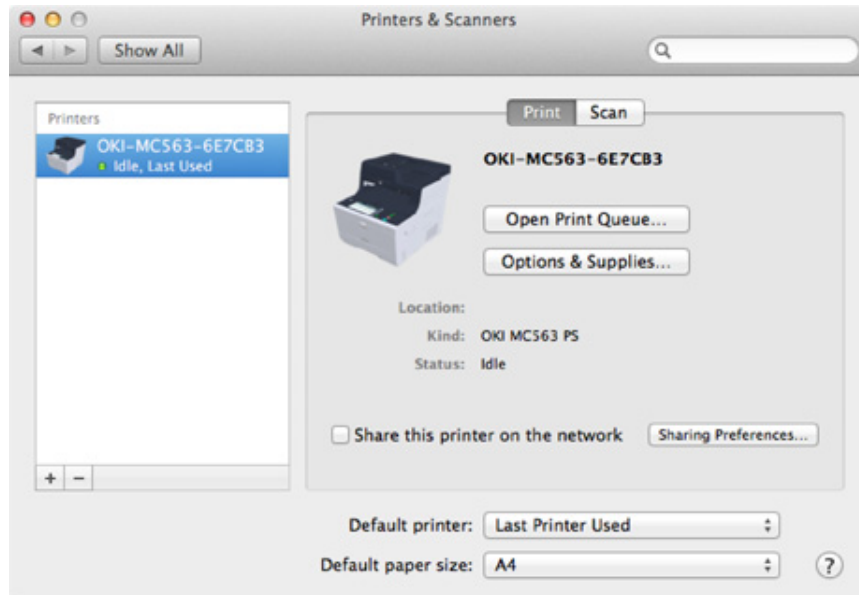

If [OKI MC563 PS] is not displayed for [Kind] correctly, click [-], delete the machine from [Printers], and then newly perform steps 8 to 12.

- 14 Click [Open Print Queue...].
- 15 Select [Print Test Page] from the [Printer] menu.

3

Basic Operations

Names of Components

Basic Operations on the Operator Panel

Turning the Machine On or Off

Loading Paper

Setting a Document

This section describes basic operations of this machine.

Names of Components

The chapter describes the name of each component.

- [Front View](#)
- [Rear View](#)
- [Inside of the machine](#)

Front View

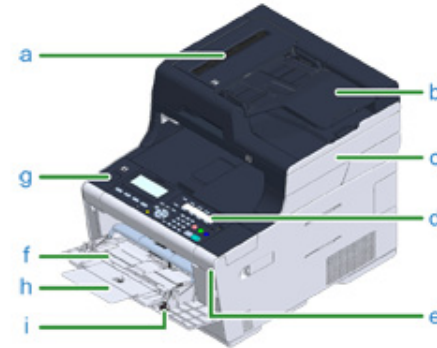

Symbol	Name
a	Auto document feeder (ADF)
b	Document tray
c	Scanner unit
d	Operator panel Basic Operations on the Operator Panel
e	USB port
f	MP tray (Multipurpose tray)
g	Open button
h	Paper supporter
i	Envelope lever (Use this when printing on envelopes. For instructions, refer to "Printing on Envelopes (Advanced Manual)".)



Symbol	Name
j	Document glass
k	Document glass cover
l	Wireless LAN module cover

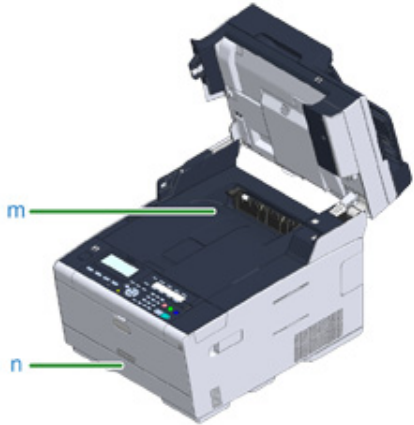

Symbol	Name
m	Output tray
n	Tray 1

Rear View

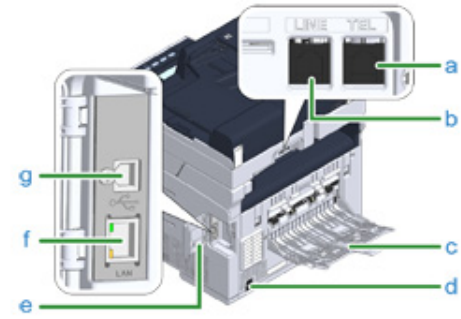

Symbol	Name
a	Telephone connector (for connecting an external telephone)
b	LINE connector
c	Rear output tray
d	Power connector
e	Interface connector cover
f	Network interface connector
g	USB interface connector

Inside of the machine

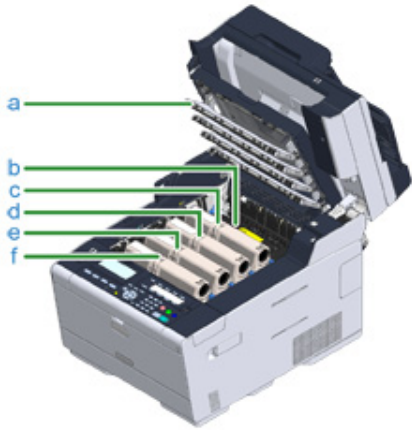

Symbol	Name
a	LED head
b	Fuser unit
c	Toner cartridge / Image drum (Y: yellow)
d	Toner cartridge / Image drum (M: magenta)
e	Toner cartridge / Image drum (C: cyan)
f	Toner cartridge / Image drum (K: black)

Basic Operations on the Operator Panel

This section describes the operator panel of the machine.

- Names and Functions
- Name and Functions on the Operator Panel
- Adjusting the Angle of the Display Screen
- Entering Characters

Names and Functions

This section describes the names and functions of components on the operator panel.

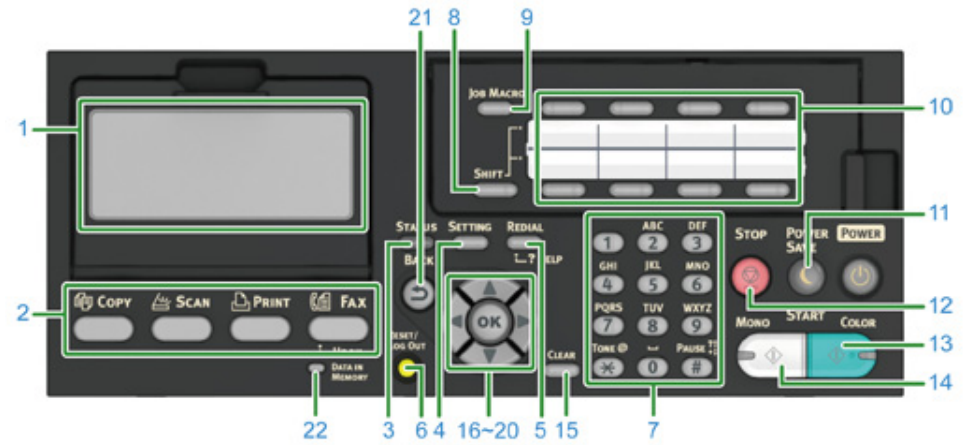

No.	Name	Function
1	Display screen	Displays operating instructions and status of the machine.
2	Function Button	Displays the top screen of each function. The selected button lights in blue.
	<FAX/Hook> button	Displays the fax function screen. Pressing this button while the fax function screen is displayed starts on hook dial operation.
	<PRINT> button	Displays the print function screen.
	<SCAN> button	Displays the scan function screen.
	<COPY> button	Displays the copy function screen.
3	STATUS	Displays the status menu. Flashes/lights up if there is an error.
4	SETTING	Displays the machine setting menu screen.
5	REDIAL/? HELP	Displays the Help screen.
6	RESET/LOG OUT	<ul style="list-style-type: none"> • On the top screen of each function, logs you out. • On the setting item function, resets a setting value and returns to the start screen of each function. • On the start screen of each function, returns to the top screen.
7	Numeric keypad	Enters numbers, alphabets, and symbols.
8	SHIFT	Switches between two e-mail addresses or fax numbers that are registered in each (ONE-TOUCH) by pressing this button and (ONE-TOUCH) at the same time.
9	JOB MACRO	Calls settings for the copy, scan or other functions. You must register settings in advance.

No.	Name	Function
10	One-touch key	Calls e-mail addresses or fax numbers that are frequently used for the copy, fax, or other functions. You must register e-mail addresses and fax numbers in advance. You can register two items in each of eight buttons, a total of 16 items.
11	POWER SAVE	Enters or exits the power saving mode. In Power Save mode, lights up in green; In Sleep mode, flashes in green (every 3 seconds); In Deep Sleep mode, flashes in green (every 6 seconds).
12	STOP	Cancels copying, fax transmissions, or other jobs.
13	START COLOR	Starts scanning in color.
14	START MONO	Starts scanning in black & white.
15	CLEAR	Executes the following actions according to the entered items when pressed or held: <ul style="list-style-type: none"> • Minimizes a setting value. • Enters zero as a setting value. • Clears what is entered. • Cancels a selected item.
16	▶ (Scroll right)	<ul style="list-style-type: none"> • Proceeds to the next screen. • Moves the cursor right during item selection or character entry.
17	▲ (Scroll up)	Moves the cursor up during item selection or character entry.
18	▼ (Scroll down)	Moves the cursor down during item selection or character entry.
19	◀ (Scroll left)	<ul style="list-style-type: none"> • Returns to the previous screen. • Moves the cursor left during item selection or character entry.
20	OK	<ul style="list-style-type: none"> • Confirms the highlighted item. • Select a check item.
21	BACK	Returns to the previous screen.
22	DATA IN MEMORY indicator	Lights up when data remains in memory.

To access the keyboard, open the one-touch-button panel. Use to enter alphabetic characters.



Name and Functions on the Operator Panel

When this machine turns on, the home screen is displayed on the operator panel.

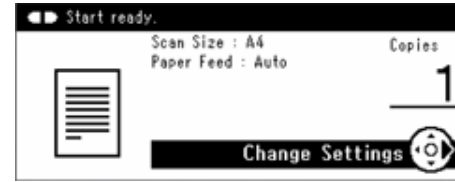

No.	Description
1	Displays the status of the machine.

• Setting Screen

The screen below is used as an example.

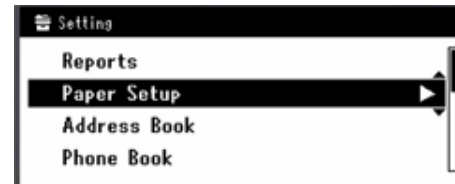

• When an error occurs

If an error occurs in the machine, the screen below appears.

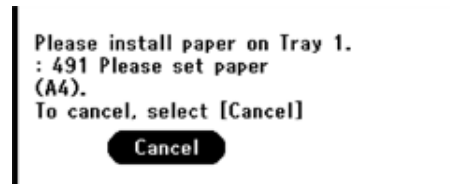

Adjusting the Angle of the Display Screen

The display screen can be tilted to improve the visibility.

- 1 Hold the upper center of the display screen and pull it forward.



Entering Characters

- [Entering Characters](#)
- [Deleting Entered Characters](#)

Entering Characters

If the character entry is required while setting an item, the entry screen appears.

Enter characters using the buttons, keyboard, or numeric keypad on the operator panel.

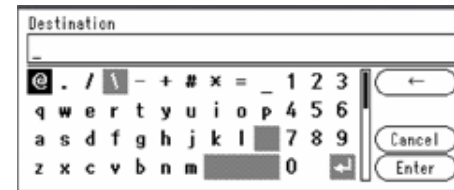

- 1 Press the ►, ◀, ▼ or ▲ button on the operator panel to select a character, and then press the  (OK) button.

Or press the keyboard for alphabetic characters or numeric keypad for numbers.



- 2 After entering all the characters, select [Enter], and then press the  (OK) button.

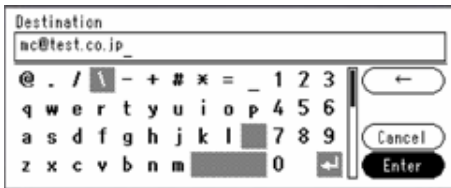

Deleting Entered Characters

Press the  (CLEAR) button on the operator panel to delete an entered character.

Press and hold the  (CLEAR) button to delete all the entered characters.

Or press the ►, ◀, ▼ or ▲ button on the operator panel to select [←], and then press the  (OK) button.

Turning the Machine On or Off

This section describes how to turn on and off the machine.

- [Turning the Machine On](#)
- [Turning the Machine Off](#)

Turning the Machine On

- 1 Check that no documents are set on the document glass or in the ADF, and the ADF cover is closed.
- 2 Press the power switch for approximately a second.



When the machine is turned on, the power switch LED lamp is lit.



- 3 The home screen appears when the machine is ready.

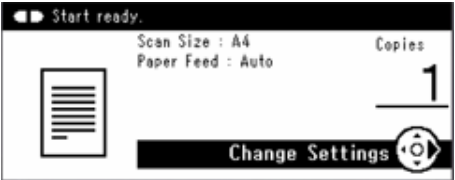

Turning the Machine Off



- Check that the machine is not receiving data before shutting down.
- Press and hold the power switch for 5 seconds or more to force shut down the machine. Use this method only if a problem occurs.

For troubleshooting of this machine, see "[Troubleshooting](#)".

- 1 Press the power switch for approximately a second.



The "System moves to shutdown. Please confirm status when status LED is blinking." message is displayed on the operator panel, and the power switch LED lamp flashes at approximately one-second intervals.

After a while, the machine automatically turns off, and the power switch LED lamp goes out.

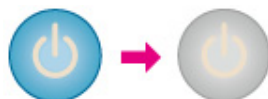

What You Should Do If You Do Not Use This Machine for an Extended Period of Time

If you do not use this machine for an extended period of time due to holidays, trips, or other reasons, unplug the power cord from the outlet.



This machine does not have functional failures if the power cord is unplugged for an extended period of time (four weeks or more).

Loading Paper

This chapter describes various information about paper that can be loaded in a paper tray of this machine.

To set paper type and weight, press the  (SETTING) button on the operator panel > [Paper Setup] and press the tray you want to use, and then select [Media Type] or [Media Weight].

- [About Paper Types That Can be Loaded](#)
- [Loading Paper in Tray 1/2/3](#)
- [Loading Paper in the MP Tray](#)
- [Paper Storage](#)

About Paper Types That Can be Loaded

- [Available paper types](#)
- [About Paper Sizes, Weight, and Number of Sheets That Can be Loaded](#)
- [Recommended paper](#)

Available paper types

To perform high-quality printing, be sure to use the supported paper types that satisfy requirements, such as material, weight, or paper surface finishing. Use digital photo print paper.

If you print on paper that is not recommended by OKI, check the print quality and the movement of the paper thoroughly in advance to ensure that there are no problems.

• Plain paper

Paper type	Paper size (mm) (Values in brackets are inch sizes.)	Paper weight
A4	210 x 297	64 to 220 g/m ² (17 to 58 lb) For duplex printing, 64 to 176 g/m ² (17 to 47 lb)
A5	148 x 210	
A6	105 x 148	
B5	182 x 257	
B6	128 x 182	
B6 Half	64 x 182	
Letter	215.9 x 279.4 (8.5 x 11)	
Legal 13	215.9 x 330.2 (8.5 x 13)	
Legal 13.5	215.9 x 342.9 (8.5 x 13.5)	
Legal 14	215.9 x 355.6 (8.5 x 14)	
Executive	184.2 x 266.7 (7.25 x 10.5)	 If you set paper that is 148 mm (5.8 inches) wide or narrower, printing becomes slower.
Statement	(5.5 x 8.5)	
8.5" SQ	(8.5 x 8.5)	
Folio (210 x 330 mm)	210 x 330	
16K (184 x 260 mm)	184 x 260	
16K (195 x 270 mm)	195 x 270	
16K (197 x 273 mm)	197 x 273	
Index Card	(3 x 5)	
4x6inch	(4 x 6)	
5x7inch	(5 x 7)	

Paper type	Paper size (mm) (Values in brackets are inch sizes.)	Paper weight
Custom size	Width: 64 to 216 Length: 90 to 1321	64 to 220 g/m ² (17 to 58 lb)

• Envelope

Paper type	Paper size (mm) (Values in brackets are inch sizes.)	Paper weight
Monarch	98.4 x 190.5 (3.875 x 7.5)	Envelopes must be made of paper of 85 g/m ² (24 lb), and their flaps must be folded.
Com-9	98.4 x 225.4 (3.875 x 8.875)	
Com-10	104.8 x 241.3 (4.125 x 9.5)	
DL	110 x 220 (4.33 x 8.66)	
C5	162 x 229 (6.4 x 9)	

• Label

Paper type	Paper size (mm) (Values in brackets are inch sizes.)	Paper weight
A4	210 x 297	0.1 to 0.2 mm
Letter	215.9 x 279.4 (8.5 x 11)	

• Other type of paper

Paper type	Paper size (mm) (Values in brackets are inch sizes.)	Paper weight
Partly-printing paper	Subject to plain paper	64 to 220 g/m ² (17 to 58 lb)
Color paper	Subject to plain paper	64 to 220 g/m ² (17 to 58 lb)

About Paper Sizes, Weight, and Number of Sheets That Can be Loaded

Available paper sizes and types, and tray capacity are as follows.

• Tray 1

Available paper size	Tray capacity	Paper weight
A4 A5 A6*1 B5 B6*1 Letter Legal (13 inches) Legal (13.5 inches) Legal (14 inches) Executive Statement*1 8.5" SQ (8.5 x 8.5 inches) Folio (210 x 330 mm) 16K (184 x 260 mm) 16K (195 x 270 mm) 16K (197 x 273 mm) Custom size*2	250 sheets (if paper weight is 80 g/m ²)	Light (64 to 74 g/m ²) Medium Light (75 to 82 g/m ²) Medium (83 to 90 g/m ²) Medium Heavy (91 to 104 g/m ²) Heavy (105 to 120 g/m ²) Ultra Heavy1 (121 to 176 g/m ²)

*1 Paper cannot be used for duplex printing.

*2 Width: 100 to 216 mm (3.9 to 8.5 inches), Length: 148 to 356 mm (5.8 to 14 inches)

• Tray 2/3 (Optional)

Available paper size	Tray capacity	Paper weight
A4 A5 B5 Letter Legal (13 inches) Legal (13.5 inches) Legal (14 inches) Executive 8.5 SQ (8.5 x 8.5 inches) Folio (210 x 330 mm) 16K (184 x 260 mm) 16K (195 x 270 mm) 16K (197 x 273 mm) Custom size*1	530 sheets (if paper weight is 80 g/m ²)	Light (64 to 74 g/m ²) Medium Light (75 to 82 g/m ²) Medium (83 to 90 g/m ²) Medium Heavy (91 to 104 g/m ²) Heavy (105 to 120 g/m ²) Ultra Heavy 1 (121 to 176 g/m ²)

*1 Width: 148 to 216 mm (5.8 to 8.5 inches), Length: 210 to 356 mm (8.3 to 14 inches)

• **MP Tray**

Available paper size	Tray capacity	Paper weight
A4	100 sheets	Light
A5	(if paper weight is 80 g/m ²)	(64 to 74 g/m ²)
A6* ¹	10 sheets (envelopes)	Medium Light
B5		(75 to 82 g/m ²)
B6* ¹		Medium
B6 Half* ¹		(83 to 90 g/m ²)
Letter		Medium Heavy
Legal (13 inches)		(91 to 104 g/m ²)
Legal (13.5 inches)		Heavy
Legal (14 inches)		(105 to 120 g/m ²)
Executive		Ultra Heavy1
Statement* ¹		(121 to 176 g/m ²)
8.5 SQ (8.5 x 8.5 inches)		Ultra Heavy2
Folio (210 x 330 mm)		(177 to 220 g/m ²)
16K (184 x 260 mm)		
16K (195 x 270 mm)		
16K (197 x 273 mm)		
Index card (3x5 inches)* ¹		
4x6inch* ¹		
5x7inch* ¹		
Custom size* ²		
Com-9* ¹		
Com-10* ¹		
Monarch* ¹		
DL* ¹		
C5* ¹		

*1 Paper cannot be used for duplex printing.

*2 Width: 64 to 216 mm (2.5 to 8.5 inches), Length: 90 to 1,321 mm (3.5 to 52 inches)

Recommended paper

The machine supports a variety of print media, including a range of paper weights and sizes. This section describes how to choose and use media. To obtain the best performance, use 75 to 90 g/m² plain paper that is designed for use in copiers and laser printers. Use of heavily embossed or very rough textured paper is not recommended. Pre-printed stationery can be used, but the ink must not offset when exposed to the high fuser temperatures used in the printing process.

• **Envelopes**

Envelopes must be free from twists, curls or other deformations. The envelopes must also be of the rectangular flap type, with glue that remains intact when subjected to hot roll pressure fusing in the machine. Window envelopes are not suitable.

• **Labels**

Labels must be of the type recommended for use in copiers and laser printers, in which the base carrier page is entirely covered by labels. Other types of label stocks may damage the machine due to the labels peeling off during the printing process.

Loading Paper in Tray 1/2/3

The procedure when loading paper in Tray 1 is used as an example, and the same procedure applies to Tray 2/3 (optional).

- 1 Pull the paper cassette out.



- 2 Slide the paper guide (a) to the width of paper to be loaded.

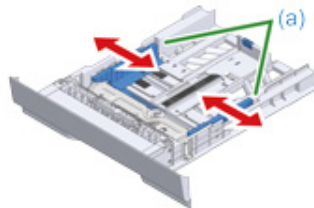

- 3 Slide the paper stopper (b) to the length of paper to be loaded.

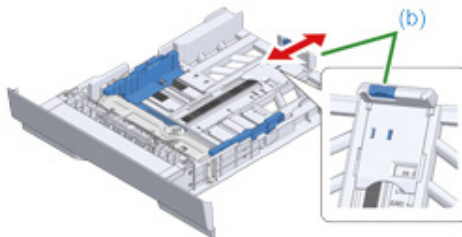

- 4 Fan a stack of paper well, and then align the edges of the paper.

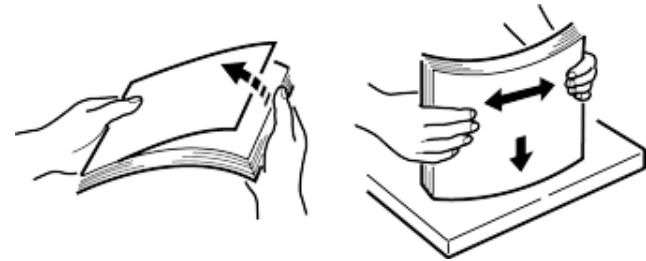

- 5 Load paper with the print side face down.



Do not load paper above the "▽" mark on the paper guide.

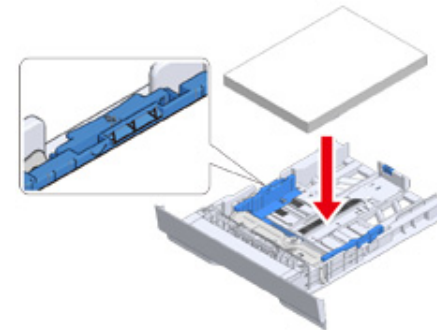

- 6 Secure the loaded paper with the paper guide.

- 7 Push the paper cassette until it stops.



- 8 Press the  (SETTING) button on the operator panel.

- 9 Press [Paper Setup].

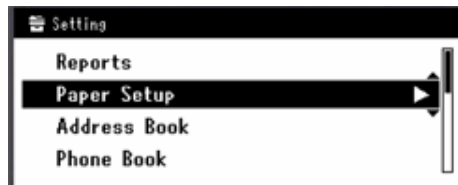

- 10 Press the tray in which paper is loaded.
- 11 Set [Paper Size], [Media Type], and [Media Weight].
- 12 Press [Back] until the home screen is displayed.

Loading Paper in the MP Tray



- Do not press down the paper or hold the paper to pull while printing on the paper fed from the MP tray. To stop printing, open the output tray. For instructions on how to remove paper, see "[If Paper Jams Occur](#)".
- If you open and close the MP tray vigorously, the paper feed roller of MP tray may fall and get in the way of loading paper.

If the paper feed roller of MP tray has fallen, raise the paper feed roller of MP tray before loading paper.

- 1 Open the MP tray forward by inserting your finger into the front recess.



- 2 Pull out the paper support by holding the center part of it.



- 3 Open the sub support.



- 4 Adjust the manual feeding paper guide to the width of paper to be loaded.



- 5 Make sure that the paper feed roller stays in the proper position.
If the paper feed roller has fallen, push it upward and fix it.

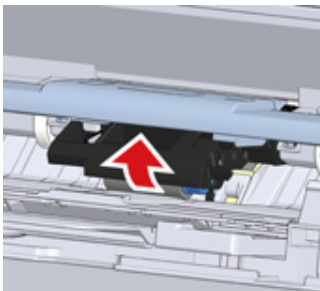

- 6 Insert the paper with the print side up until its edge touches the paper feed entrance.



Do not load paper above the "▽" mark.



When a printer is in the power saving mode, press the  (Power Save) button to restore from the mode.

- 7 Set [Paper Size], [Media Type], and [Media Weight] on the paper setup screen.

- 8 Press [Close].



- Do not load paper in different sizes, types, or weights.
- When adding sheets of paper, remove paper loaded in the MP tray, bundle the whole batch of sheets, and align edges of sheets to load them.
- Do not insert objects other than paper in the MP tray.

Paper Storage

Store paper under the following conditions to maintain quality.

- Inside a cabinet or other dry and dark place
- On a flat surface
- Temperature: 20°C
- Humidity: 50% RH (relative humidity)

Do not store paper in the places as shown below:

- Directly on the floor
- Where paper is exposed to direct sunlight
- Near the inside of an exterior wall
- On an uneven surface
- Where static electricity may be generated
- Where temperature excessively rises high and temperature rapidly changes
- Near this machine, an air conditioner, a heater, or duct



- Do not unwrap paper until just before you use.
- Do not leave paper unwrapped for a long period. Doing so may result in printing problems.
- Depending on the print media, environment, storage conditions, the print quality may deteriorate or printout may get curled

Setting a Document

This chapter describes how to set the document on this machine.

- [About Documents That Can be Set](#)
- [Setting in the ADF](#)
- [Setting on the Document Glass](#)

About Documents That Can be Set

• About Where to Set a Document

Set a document in the ADF or on the document glass when copying, scanning, or faxing.

• ADF

Scannable size	A4, A5, A6, B5, B6, Letter, Legal 13/13.5/14, Executive, Statement, 8.5 SQ, Folio
Paper capacity	50 sheets (80 g/m ²) or maximum rise of 5 mm (0.2 inches)
Paper weight	60 to 105 g/m ² (16 to 28 lb)

• Document glass

Scannable size	A4, A5, A6, B5, B6, Letter, Executive, Statement, 8.5 SQ
Document thickness	Up to 20 mm



Duplex scan is not available for A6.



For documents on which adhesives, ink, or correction fluid is used, make sure that they have completely dried before setting.

• About Documents That Cannot be Set in the ADF

You cannot set the following documents in the ADF. Set the document on the document glass.

- Documents with holes or tears
- Documents folded or damaged
- Documents with fold lines or badly curled, or rolled documents
- Damp documents
- Documents that are stuck together due to static electricity
- Carbon-backed documents
- Cloth, metal sheets, OHP films
- Stapled, clipped, taped documents or documents with sticky notes
- Documents that are pasted each other, or documents with glue
- Glossy documents
- Coated documents

- Documents still wet with ink or correction fluid

Observe the following to avoid damaging the document glass.

- When copying a thick document, do not press on it on the document glass.
- Place a hard document gently.
- Do not set a document that has sharp protrusions.

- **About the Scannable Area**

Texts or images within the 2 mm area from the edges of standard paper cannot be scanned.

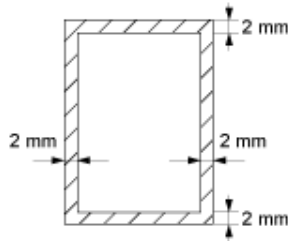

Setting in the ADF



Do not jog a document stack on the ADF cover.

It may cause the document feed roller of ADF to fall and get in the way of loading documents.

- 1 Open the ADF cover.



- 2 Push the document feed roller into the ADF cover.



3 Close the ADF cover.



4 Set a document face up in the ADF.

If [Direction] is set to [Landscape], set the document so that its left edge is pulled into the ADF first.



If [Direction] is set to [Portrait], set the document so that its top edge is pulled into the ADF first.



5 Align the document guide to the document width.



- If document feed problems often occur when documents are sent from the ADF, reduce the number of document pages to set.
- Documents of up to 50 sheets (80 g/m²) and 5 mm high can be loaded regardless of the size.
- If documents to be set on the ADF are curled, adjust the document guides to fit the document width.



Setting on the Document Glass

- 1 Open the document glass cover.
- 2 Set a document face down on the document glass.
If [Direction] is set to [Portrait], align the top edge of the document with the upper-left corner of the glass.



If [Direction] is set to [Landscape], align the right edge of the document with the upper-left corner of the glass.



Do not press the document glass forcefully.



- 3 Close the document glass cover gently.



Do not close the document cover vigorously.

It may cause the document feed roller of ADF to fall and get in the way of loading documents.

If the document feed roller of ADF has fallen, open and close the ADF cover.

4

Copy

Copying





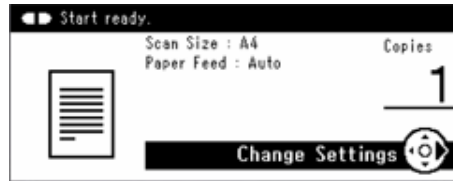

Cancelling Copying

Specifying the Number of Copies

Copying

- 1 Press the  (COPY) button on the operator panel.



- 2 Set a document in the ADF or on the document glass.
- 3 Set the copy setting if necessary.
 -  Useful Functions (Advanced Manual)
 -  For a Better Finish (Advanced Manual)
 -  Color Settings (Advanced Manual)
 -  Advanced Copy Settings (Advanced Manual)
- 4 Press the  (MONO) or  (COLOR) button.

Cancelling Copying

You can cancel copying before a message is displayed to inform you that copying is complete.

- 1 Press the  (STOP) button when scanning the document.





Specifying the Number of Copies

- 1 Press the  (COPY) button on the operator panel.
- 2 Set a document in the ADF or on the document glass.
- 3 Enter the number of copies by using the numeric buttons.



- You can enter the number of copies from 1 to 99.
- If you enter an incorrect value, press the  (CLEAR) button, and then enter the correct value.

- 4 Press the  (MONO) or  (COLOR) button.



-  [Sorting Each Set in Page Order \(Sort\) \(Advanced Manual\)](#)

5

Scan

Sending Scanned Data as an E-mail Attachment

Saving Scanned Data in a Shared Folder

Cancelling Scanning



Sending Scanned Data as an E-mail Attachment

This section describes how to send scanned data as an e-mail attachment.

- [Before Using Scan To E-mail](#)
- [Entering E-mail Address to Send E-mail](#)
- [Specifying a Destination from Address Book or Group List \(Advanced Manual\)](#)
- [Specifying a Destination Using One-touch Button \(Advanced Manual\)](#)
- [Specifying a Destination from Transmission History \(Advanced Manual\)](#)
- [Specifying a Destination Searching LDAP Server \(Advanced Manual\)](#)
- [Setting the Sender's Address \(Advanced Manual\)](#)
- [Setting the Reply Address \(Advanced Manual\)](#)
- [Registering an E-mail Template \(Advanced Manual\)](#)
- [Using an E-Mail Template \(Advanced Manual\)](#)
- [Saving Transmission Data \(Advanced Manual\)](#)
- [Checking Results of Scan To E-mail \(Advanced Manual\)](#)



Before Using Scan To E-mail

If the machine is set up from [Easy Setup] > [E-mail Setting], skip Before Using Scan To E-mail. If the information is not set, set up in the following procedure.

- 1 Check the information related to E-mail following the steps in "[Checking the Setting Information](#)".
- 2 Press the  (SETTING) button on the operator panel.
- 3 Press the  button to select [Easy Setup] and press the  (OK) button.
- 4 Enter the administrator password, and then press [Enter].





The factory default password is "999999". If the administrator password is changed after installing the machine, enter the updated password.

- 5 Press the  button to select [E-mail Setting] and press the  button.
- 6 Press [Next].
- 7 Follow the onscreen instruction to enter the information checked in Step 1.









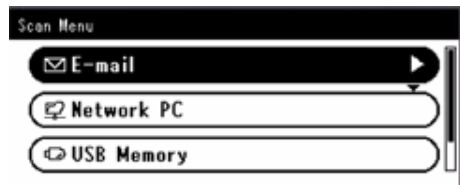

[E-mail Setup \(Advanced Manual\)](#)



Entering E-mail Address to Send E-mail

- 1 Press the  (SCAN) button on the operator panel.
- 2 Set a document in the ADF or on the document glass.
- 3 Check that [E-mail] is selected, and then press the  (OK) button.



- 4 Check that [Add Destination] is selected, and then press the  (OK) button.
- 5 Check that [To] is selected, and then press the  (OK) button.
To select [Cc] or [Bcc], press  several times, and then press the  (OK) button.
- 6 Press the  button to select [Manual Input] and press the  (OK) button.
- 7 Enter an e-mail address.
You can enter up to 80 characters.
- 8 Set scan settings if necessary.
- 9 Press the  (MONO) or  (COLOR) button.



-  Specifying a Destination from Address Book or Group List (Advanced Manual)
-  Specifying a Destination Using One-touch Button (Advanced Manual)
-  Specifying a Destination Searching LDAP Server (Advanced Manual)

Saving Scanned Data in a Shared Folder

This section describes how to save scanned data in a shared folder on a network.

- [Creating a Shared Folder in a Computer](#)
 - [Registering a Destination \(Profile\)](#)
 - [How to Use Scan To Shared Folder](#)
 - [Changing a Destination \(Profile\) from the Operator Panel \(Advanced Manual\)](#)
 - [Deleting a Destination \(Profile\) from the Operator Panel \(Advanced Manual\)](#)
 - [Tables of Profile Setting Items \(Advanced Manual\)](#)
-

Creating a Shared Folder in a Computer



If you create a shared folder in the following steps, all users whose accounts are set in your computer can access the shared folder.



Create a shared folder in a computer in which the scanned document is saved.

- 1 Click [Start] on the Windows task bar, right-click [Computer], and then click [Properties].
- 2 Check the name of [Computer name].
You need the computer name you checked when you register the destination in the machine. Write it down.
- 3 Close the window.
- 4 Create a folder in which documents are saved on the computer.
- 5 Right-click the created folder, and then click [Properties].
- 6 Click the [Sharing] tab, and then click [Advanced Sharing].
- 7 Select the [Share this folder] check box, and then click [Permissions].
- 8 Select the [Allow] check box of [Change] in [Permissions for Everyone], and then click [OK].
- 9 Click [OK].









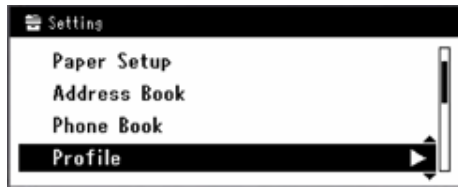

Registering a Destination (Profile)

Create a shared folder and register to the machine as a destination.

Up to 50 profiles can be registered.

- 1 Press the  (SETTING) button on the operator panel.
- 2 Press the  button to select [Profile], and then press the  (OK) button.











- 3 Press the  button to select a profile number you want to register, and then press the  (OK) button.
 - 4 Check that [Register] is selected, and then press the  (OK) button.
 - 5 Check that the profile name is selected, and then press the  button.
 - 6 Enter a profile name.
 - 7 Select [Enter], and then press the  (OK) button.
 - 8 Press the  button to select [Target URL], and then press the  button.
 - 9 Enter the values of the transmission destination computer name and the shared folder name in the "\\the transmission destination computer name\the shared folder name" format.
Example: \\PC1\share
- 
- If there is no DNS server in the network, you cannot specify the computer with the computer name (the transmission destination computer name). In such a case, use the IP address of the computer to set.
Example: \\192.168.0.3\share
- 10 Select [Enter], and then press the  (OK) button.
 - 11 Press the  button to select [User Name], and then press the  button.

- 12 Enter a user name.



- If domain management is enabled, enter "User name2@domain name".
- If domain management is enabled and you cannot establish a connection even after entering "User name2@domain name", delete "@domain name". Follow the instructions you can find on the web site, access the Web page of this machine, select [Admin Setup] > [Network Menu], and then set the NetBIOS domain name in [Workgroup name] in [NBT/NetBEUI]. For the domain name, check with your network administrator.

- 13 Select [Enter], and then press the  (OK) button.
- 14 Press the  button to select [Password], and then press the  button.
- 15 Enter a password.
- 16 Select [Enter], and then press the  (OK) button.
- 17 Press the  button to select [File Name], and then press the  button.
- 18 Enter the scan file name.
 - If you add "#n" at the end of the file name, a serial number is automatically added to the end of the file name to be sent.
 - If you add "#d" at the end of the file name, the date is automatically added to the end of the file name to be sent.
- 19 Select [Enter], and then press the  (OK) button.
- 20 Set other items if necessary.
- 21 Press the  (OK) button to define the setting.

How to Use Scan To Shared Folder

Scanned data is converted into a PDF, JPEG, TIFF, or XPS file, and then sent to the shared folder. PDF is set by factory default.







Connect the machine to a network and create a shared folder on the computer before using the Scan To Shared Folder function.

 [Connecting a LAN Cable/USB Cable](#)

 [Creating a Shared Folder in a Computer](#)



The following procedure uses the factory default setting.

- 1 Press the  (SCAN) button on the operator panel.
- 2 Set a document in the ADF or on the document glass.
- 3 Press the ▼ button to select [Shared Folder], and then press the  (OK) button.
- 4 Check that [Select Profile] is selected, and then press the  (OK) button.
- 5 Press the ▼ button to select a profile, and then press the  (OK) button.
- 6 Press the  (MONO) or  (COLOR) button.

Cancelling Scanning

You can cancel scanning while a message is being displayed to inform you that scanning is in progress.

- 1 Press the  (STOP) button on the operator panel.



6

Print

Printing from a Computer (Windows)

Printing from a Computer (Mac OS X)

Cancelling a Print Job

About Screens and Functions of Each Printer Driver

"WordPad" for Windows and "TextEdit" for Mac OS X are used as examples. The screens and steps may vary depending on the application.

Printing from a Computer (Windows)

- [For Windows PCL Printer Driver](#)
- [For Windows PS Printer Driver](#)

For Windows PCL Printer Driver

- 1 Open the file to print.
- 2 Select [Print] from the [File] menu.
- 3 Select the printer driver.
- 4 Click [Preferences].

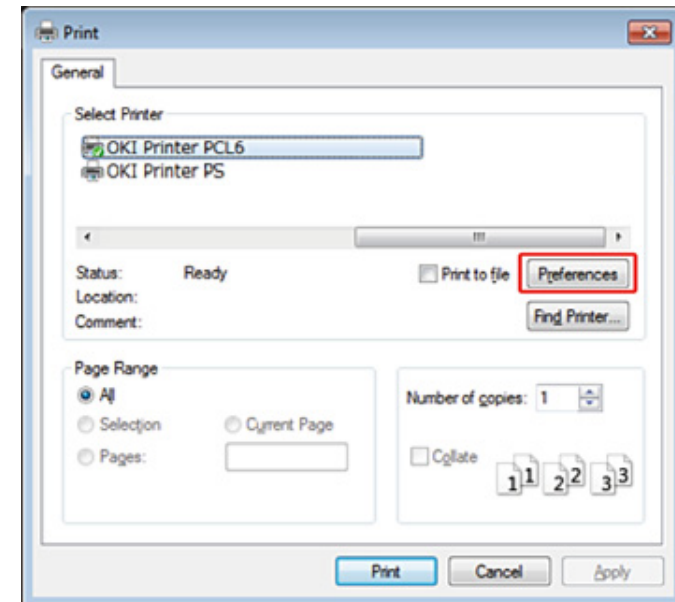

- 5 Change the settings in each tab to suit your needs.

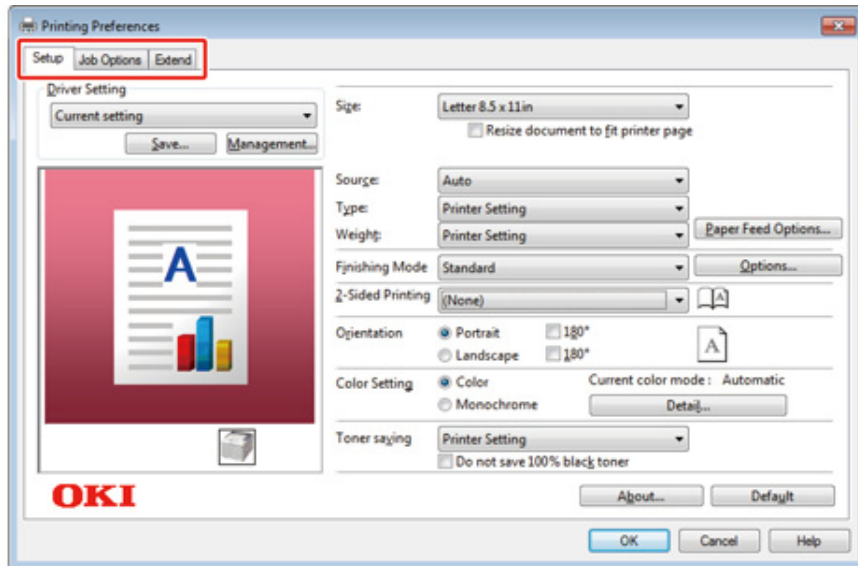

- 6 Click [OK].
- 7 Click [Print] on the [Print] Screen.

For Windows PS Printer Driver

- 1 Open the file to print.
- 2 Select [Print] from the [File] menu.
- 3 Select the PS printer driver.
- 4 Click [Preferences].

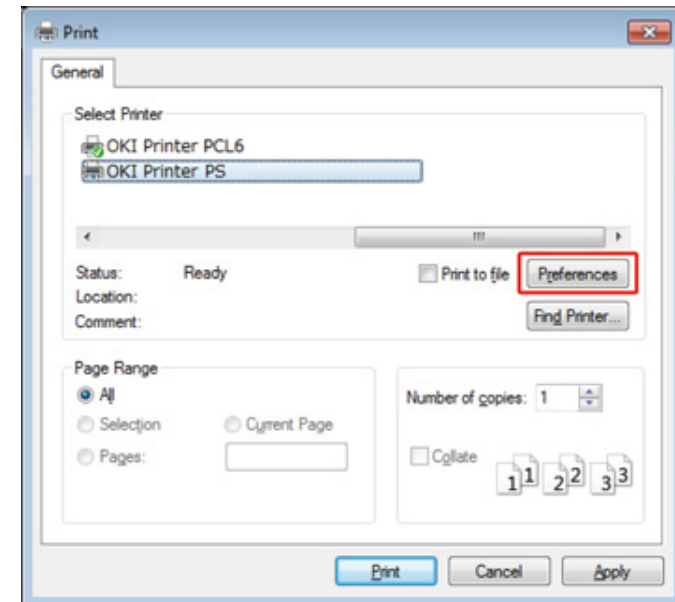

5 Change the settings in each tab to suit your needs.

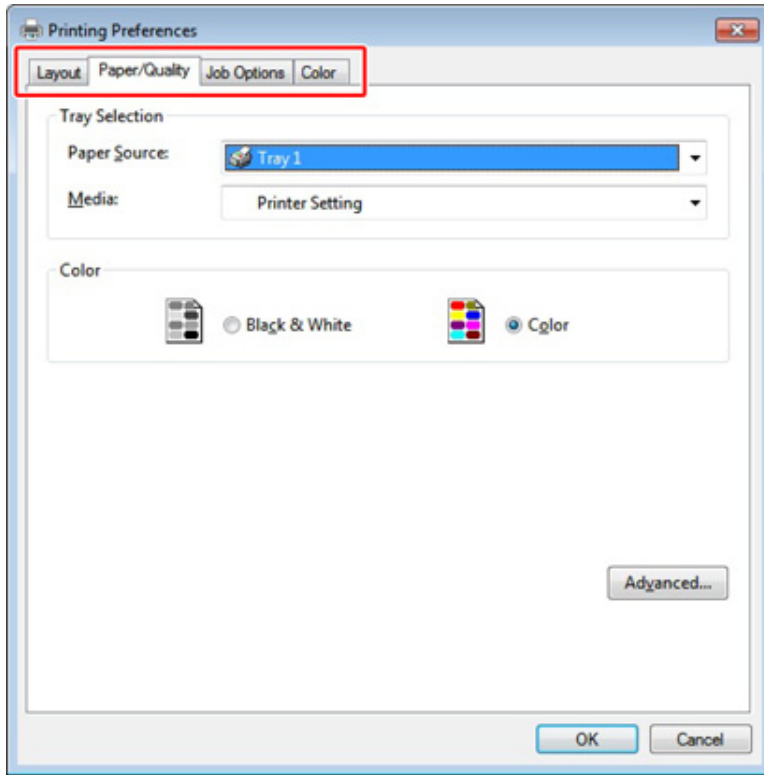

6 Click [OK].

7 Click [Print] on the [Print] screen.

Printing from a Computer (Mac OS X)

You can set a paper size, paper tray, and paper weight, and paper type with the printer driver.

- 1 Open the file to print.
- 2 Select [Print] from the [File] menu.

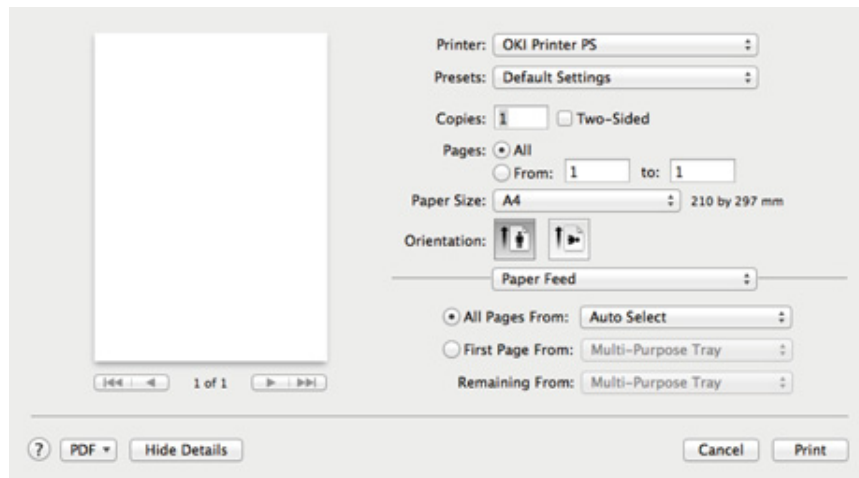

- 3 Select the machine from [Printer].
- 4 Select the paper size from [Paper Size].
- 5 Change the settings on each panel to suit your needs.



If setting details are not displayed in the print dialog box for Mac OS X 10.8.5 to 10.11, click [Show Details] at the bottom of the dialog box.

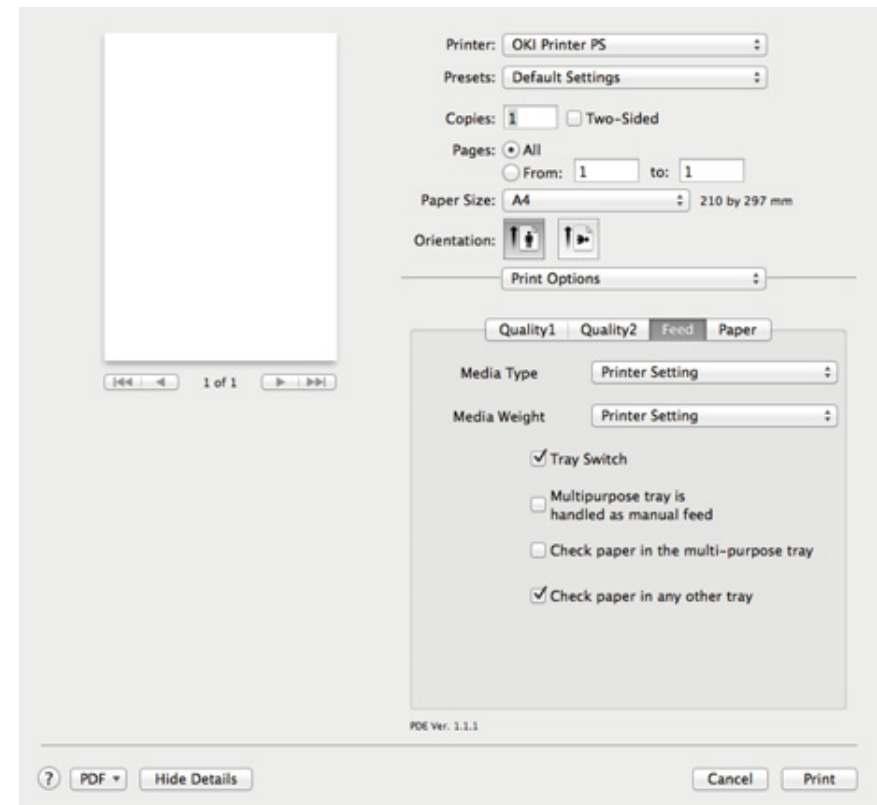

- 6 Click [Print].









Cancelling a Print Job

To cancel printing an ongoing job, press  (STOP) on the operator panel.

You can cancel a print job by deleting the job in the job list displayed on the operator panel.



- The pages that are ready to be printed on this machine cannot be cancelled.
- If the operator panel indicates that printing is in progress for a long time, delete the print job from the computer.

- 1 Press the  (PRINT) button on the operator panel.
- 2 Check that [Job List] is selected, and then press the  (OK) button.
- 3 Press the  button to select a job to cancel, and then press the  (OK) button.
- 4 Check that [Delete] is selected, and then press the  (OK) button.
- 5 Press the  or  button on the confirmation screen to select [Yes], and then press the  (OK) button.

About Screens and Functions of Each Printer Driver

This section describes screens and functions of the printer drivers.

- Windows PCL Printer Driver
- Windows PS Printer Driver
- Mac OS X PS Printer Driver

Windows PCL Printer Driver

• [Setup] Tab

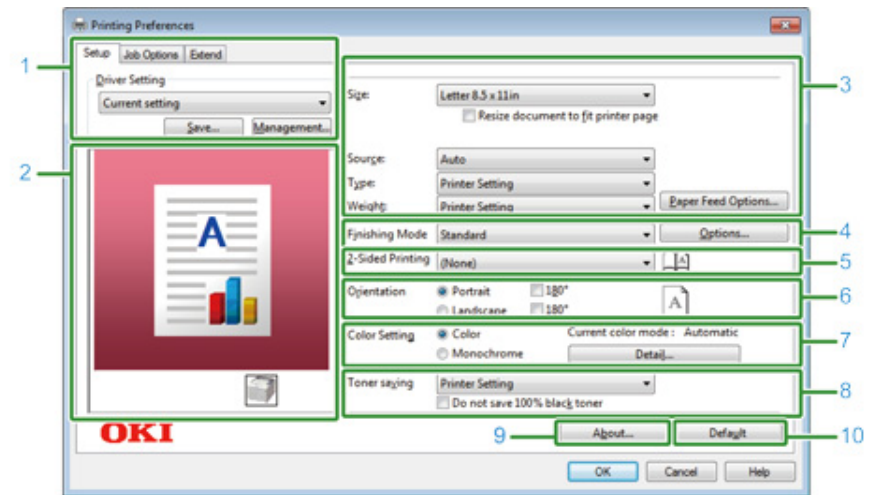

	Item	Description
1	Driver Setting	Saves your settings.
2	Image layout	Displays a sample image for the set layout.
3	Media	Specifies the paper size, type, weight, paper feed method, or other settings.
4	Finishing Mode	Specifies the multi-page printing, booklet printing, poster printing, or other settings.
5	2-Sided Printing (Duplex)	Specifies this setting when you want to perform duplex printing.
6	Orientation	Specifies the printing direction.
7	Color Setting	Switches between color printing and monochrome printing.
8	Toner saving	Decreases the print density to save toner.
9	About	Displays the version of the printer driver.
10	Default	Resets the settings on the tab to their default settings.

- [Job Options] Tab

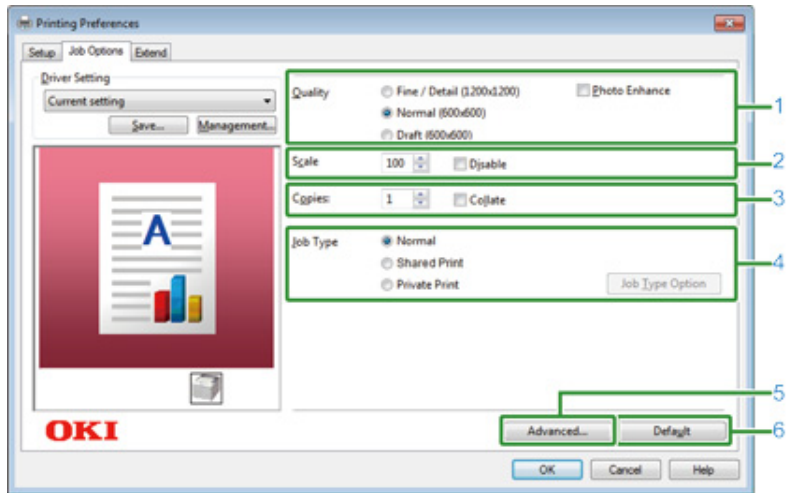

	Item	Description
1	Quality	Specifies the resolution for printing.
2	Scale	Specifies the enlargement/reduction rate for printing.
3	Copies	Specifies the number of copies to print.
4	Job Type	Specifies the print type.
5	Advanced	Sets other printing settings.
6	Default	Resets each setting value in the tab to its default setting value.

- [Extend] Tab

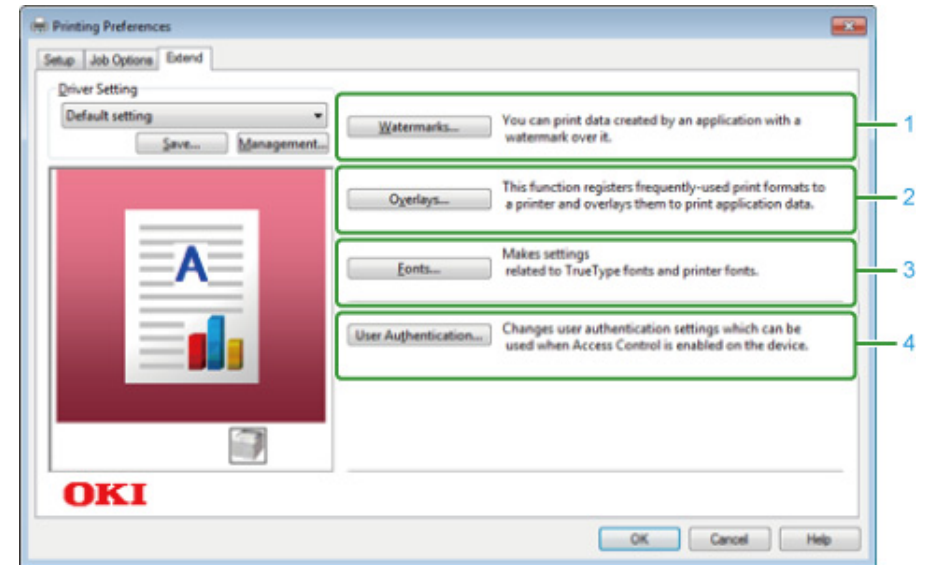

	Item	Description
1	Watermarks	Specifies when you want to use stamp print.
2	Overlays	Store the print formats to printer, or sets when printing print formats which are registered to the printer beforehand as overlays.
3	Fonts	Specifies TrueType fonts and printer fonts.
4	User Authentication	Specifies the user authentication.

Windows PS Printer Driver

• [Layout] Tab

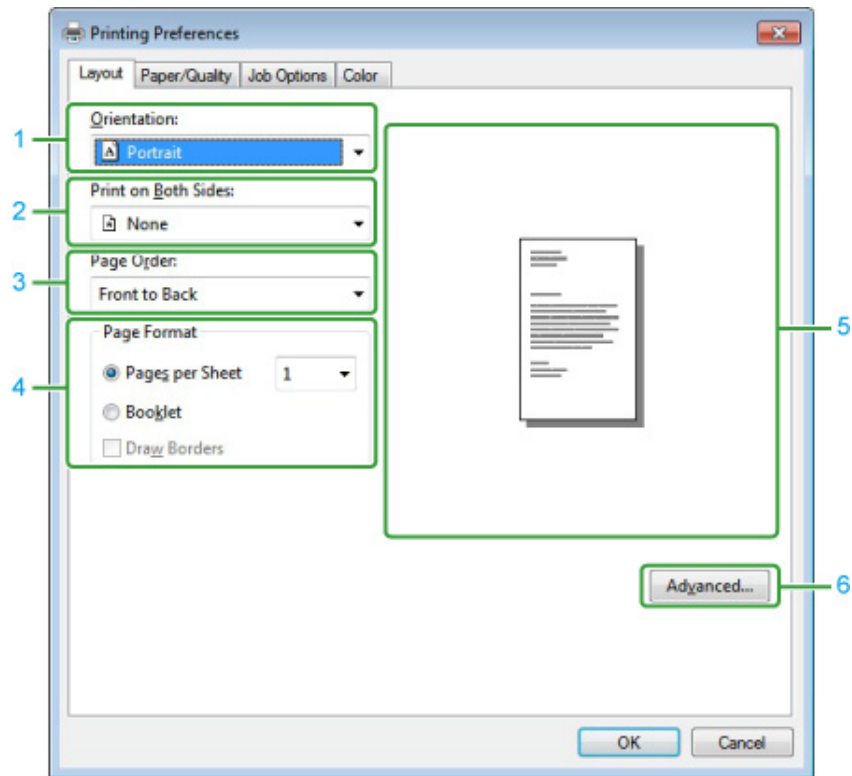

	Item	Description
1	Orientation	Specifies the printing direction.
2	Print on Both Sides	Specifies this setting when you want to perform duplex printing.
3	Page Order	Specifies a page order to print.
4	Page Format	Specifies the number of pages that is printed on a sheet of paper and booklet printing.
5	Image layout	Displays a sample image for the set layout.
6	Advanced	Allows you to set detailed settings for print quality and a paper size.

• [Paper/Quality] Tab

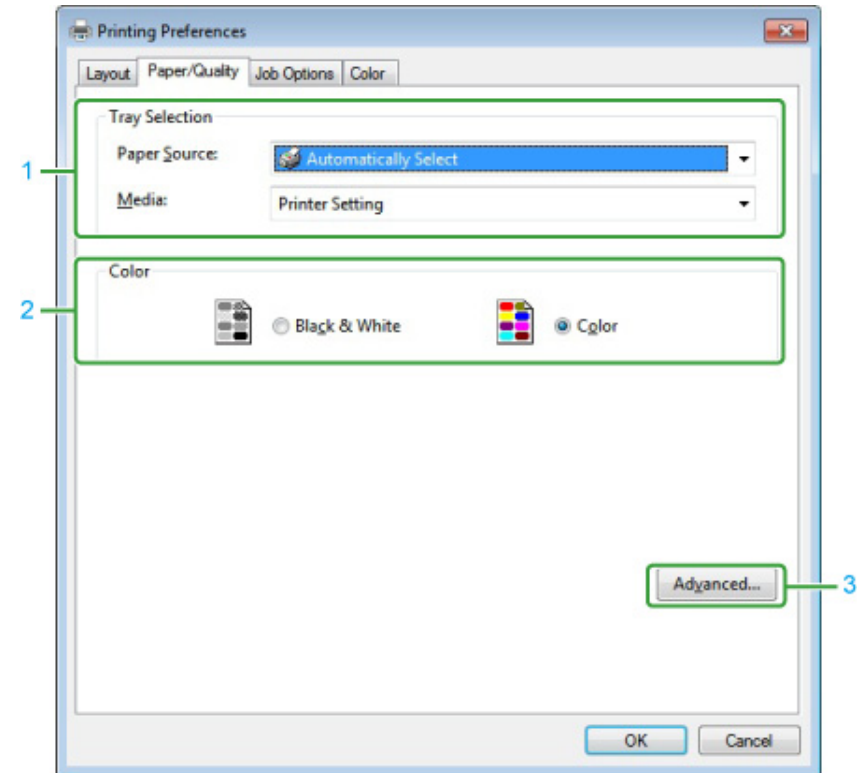

	Item	Description
1	Tray Selection	Changes the paper feed tray.
2	Color	Selects Color or Black & White.
3	Advanced	Allows you to set detailed settings for print quality and a paper size.

• [Job Options] Tab

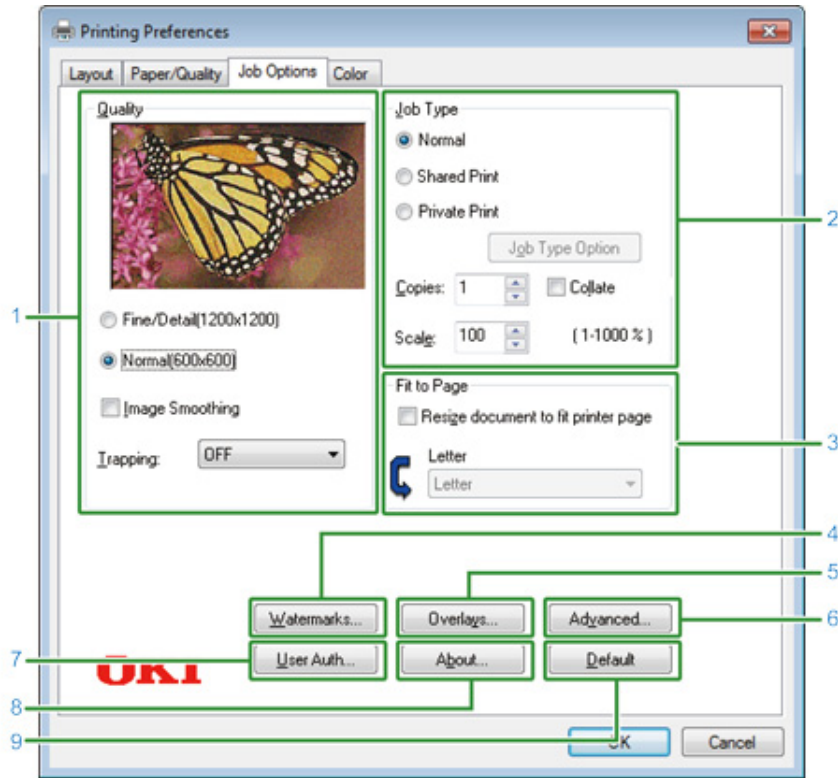

	Item	Description
8	About	Displays the version of the printer driver.
9	Default	Resets the settings on the tab to their default settings.

• [Color] Tab

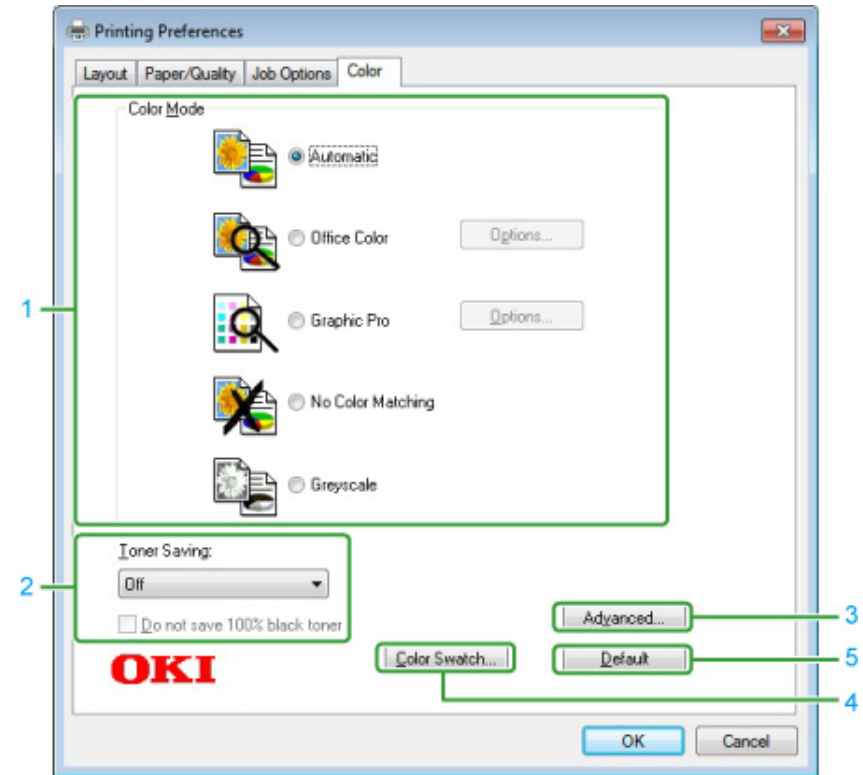

	Item	Description
1	Color Mode	Specifies the color adjustment for color printing.
2	Toner Saving	Saves toner when printing.
3	Advanced	Sets some other printing settings.
4	Color Swatch	Starts Color Swatch Utility.
5	Default	Resets the settings on the tab to their default settings.

	Item	Description
1	Quality	Specifies the resolution for printing. If you set [Toner Saving], the print density decreases to save toner.
2	Job Type	Specifies the job type and the number of copies to print. [Job Type Option] can be used if [Shared Print] or [Private Print] is selected. If you select the [Collate] check box, multiple documents are printed in units of copies.
3	Fit to Page	If you select the [Resize document to fit printer page] check box, a document is printed on paper of a different size from that of the document.
4	Watermarks	Specifies when you want to use stamp print.
5	Overlays	Sets when printing print formats which are registered to the printer beforehand as overlays.
6	Advanced	Sets other print options.
7	User Auth	Specifies the user authentication.

Mac OS X PS Printer Driver

• [Layout] Panel

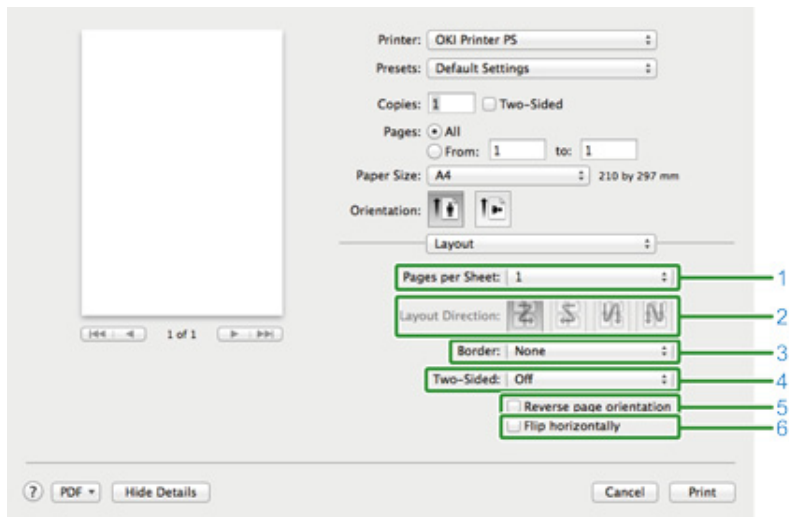

	Item	Description
1	Pages per Sheet	Selects the number of pages that is printed on a sheet of paper.
2	Layout Direction	Specifies the layout that is applied when printing multiple pages on a sheet of paper.
3	Border	Specifies a type of a boundary.
4	Two-Sided	Specifies when performing duplex printing.
5	Reverse page orientation	Reverses the direction of a page to print by selecting this check box.
6	Flip horizontally	Flips left and right to print by selecting this check box.

• [Color Matching] Panel

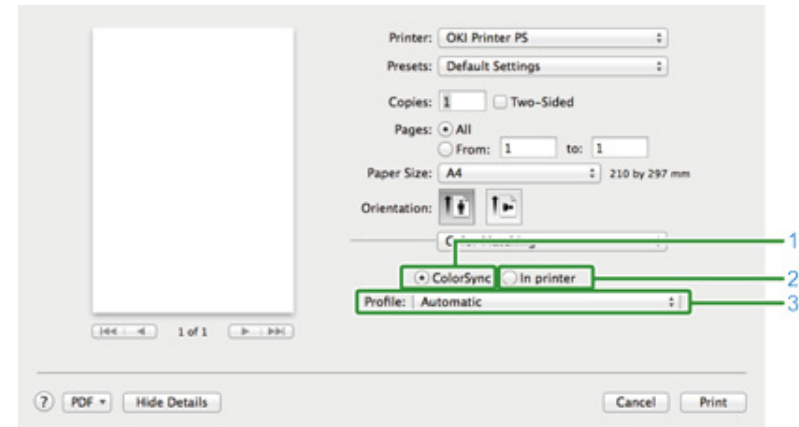

	Item	Description
1	ColorSync	Specifies the ColorSync function.
2	In printer	Performs color matching with this machine.
3	Profile	Specifies a profile.

• [Paper Handling] Panel

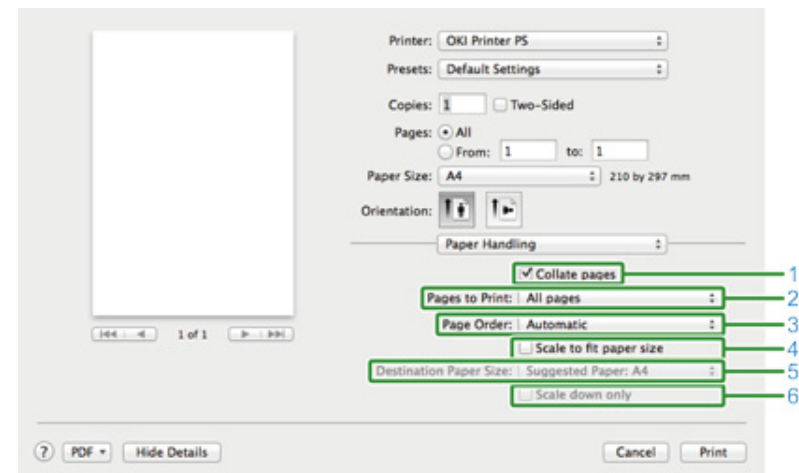

	Item	Description
1	Collate pages	Prints in units of copies by selecting this check box.

	Item	Description
2	Pages to Print	Specifies pages to print.
3	Page Order	Specifies a page order to print.
4	Scale to fit paper size	Prints to fit a paper size. A document may not be printed correctly depending on the setting. Enlarges or reduces a document to fit the output paper size by selecting this check box.
5	Destination Paper Size	Selects the output paper size when the [Scale to fit paper size] check box is selected.
6	Scale down only	Only reduces a document to fit the output paper size by selecting this check box.

• [Paper Feed] Panel

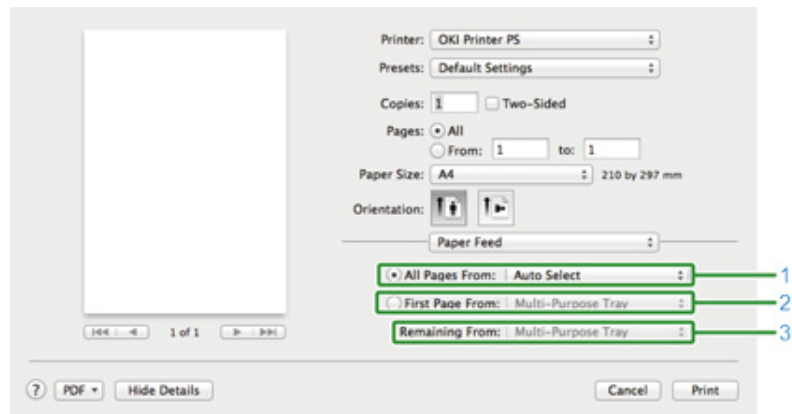

	Item	Description
1	All Pages From	Specifies the paper feed tray. If you specify [Auto Select], a tray is automatically selected.
2	First Page From	Select this setting to print only the first page from the specified tray.
3	Remaining From	Select this setting to print the remaining pages from the specified tray.

• [Cover Page] Panel

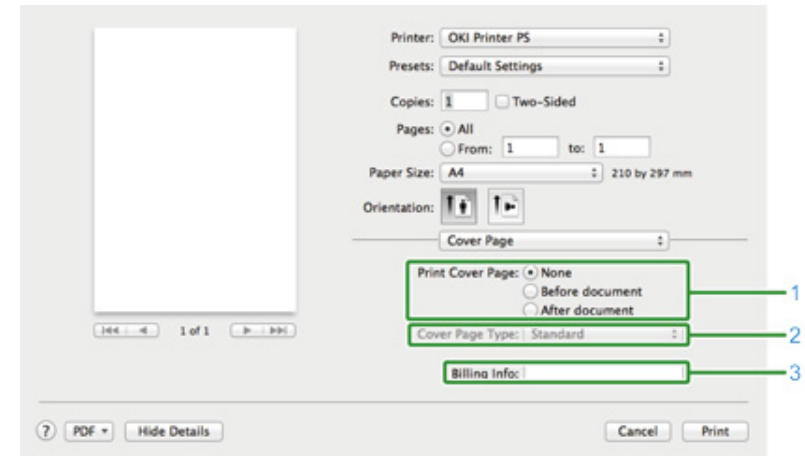

	Item	Description
1	Print Cover Page	Specifies the cover printing.
2	Cover Page Type	Specifies a string when printing the cover.
3	Billing Info	This function is not available.

• [Color] Panel

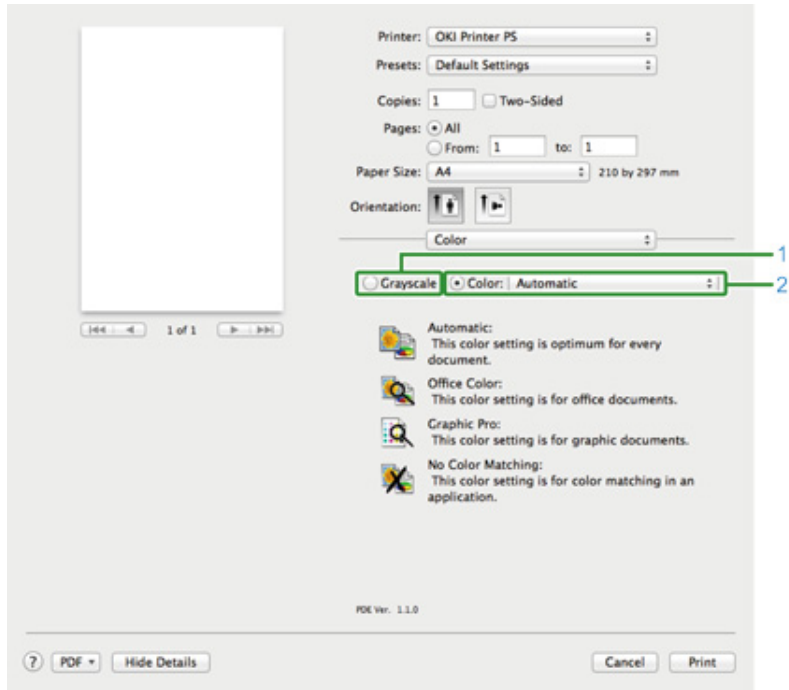

	Item	Description
1	Grayscale	Specifies to use monochrome printing.
2	Color	Specifies alignment to color mode when printing in color.

• [Print Options] Panel

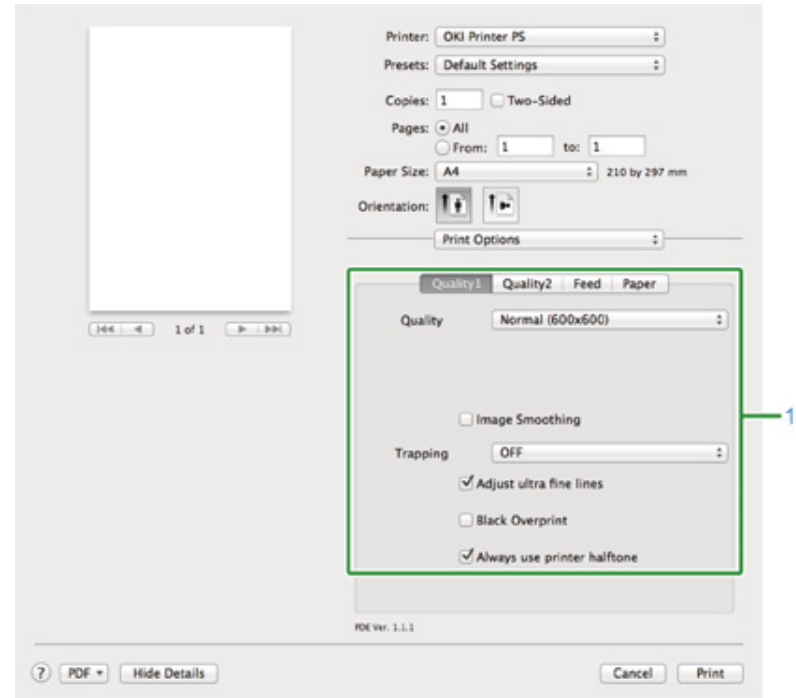

	Item	Description
1	Quality1, Quality2, Feed, Paper	Specifies the print quality, toner saving, paper type, etc.

- [User Authentication] Panel

	Item	Description
1	Use User Authentication	Select this check box if you set user authentication when printing.
2	User Name	The user name for user authentication.
3	Password	The password for user authentication.
4	Authentication type	Specify an authentication type to be used.
5	Summary Account	Specify an account name and type.

- [Secure Print] Panel

	Item	Description
1	Job Type	Specifies the job type. [Job Type Option] can be used if [Shared Print] or [Private Print] is selected.
2	Job Type Option	Specify a job name to be displayed on the operator panel and password required when printing.

• [Supply Levels] Panel

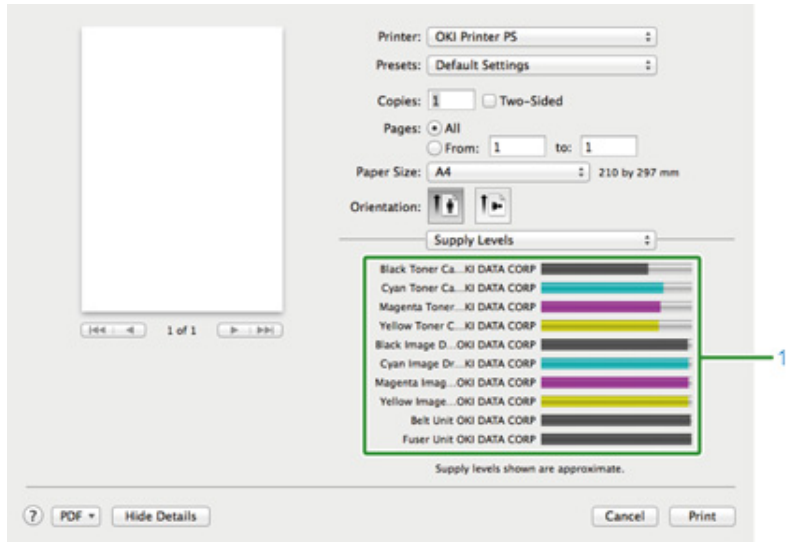

	Item	Description
1	Consumables	Displays the remaining amount of consumables.

7

Fax



Basic Operations of Fax Functions
Setting for Receptions

Basic Operations of Fax Functions



This section describes basic operations when sending and receiving a fax.

- [Entering Fax Number to Send a Fax](#)
- About the Dial Function (Advanced Manual)
- Specifying a Destination from Phone Book (Advanced Manual)
- Specifying a Destination Using One-touch Button (Advanced Manual)
- Specifying a Destination from Transmission History and Reception History (Advanced Manual)
- Deleting a Specified Destination (Advanced Manual)
- [Cancelling a Fax Transmission](#)
- Receiving a Fax (Advanced Manual)
- Specifying a Tray to Be Used When Printing Received Fax (Advanced Manual)
- Paper Size Priority (Advanced Manual)
- Checking the Communication Status/Transmission and Reception History (Advanced Manual)
- Items on Transmit and Receipt Journal Report (Advanced Manual)

Entering Fax Number to Send a Fax

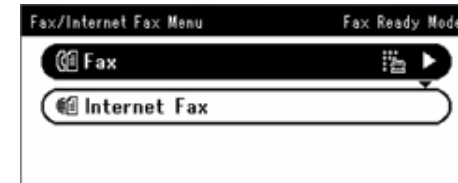
- 1 Press the  (FAX) button on the operator panel.
- 2 Set a document in the ADF or on the document glass.
- 3 Check that [Fax] is selected, and then press the  (OK) button.



- 4 Check that [Add Destination] is selected on the start screen, and then press the  button.
- 5 Press the  button to select [Manual Dial], and then press the  (OK) button.
- 6 Enter the destination number, and then press [OK].
- 7 Change settings if necessary.



- The default settings for sending a fax are as follows.
 [Scan Size]: A4 or Letter
 [Resolution]: Normal
 [Density]: 0
- You can change the default settings by pressing the  (SETTING) button > [Admin Setup] on the operator panel.

 [Fax Setup \(Advanced Manual\)](#)

- 8 Press the  (MONO) button.

Cancelling a Fax Transmission

- Cancelling During a Transmission
- Cancelling a Reserved Transmission

Cancelling During a Transmission

You can cancel a fax transmission when a message is displayed and scanning is in progress.







- 1 Press the  (STOP) button.







Cancelling a Reserved Transmission



If you select broadcast, the broadcast job is cancelled.

- 1 Press the  (FAX) button on the operator panel.
- 2 Check that [Fax] is selected, and then press the  (OK) button to open the start screen.
- 3 Press the  button to select [Fax Job View/Cancel], and then press the  (OK) button.
- 4 Press the  button to select a job to cancel, and then press the  (OK) button.
- 5 Check the job, and then press the  button.

- 6 Press the  button to select [Delete Reserved Tx], and then press the  (OK) button.

- 7 Press the  or  button on the confirmation screen to select [Yes], and then press the  (OK) button.



If you select broadcast, the broadcast job is cancelled.



A fax that is being sent is displayed on the top of the list.

Setting for Receptions

This section describes various settings when receiving a fax.

- [Setting the Reception Mode](#)
- [DRD](#)
- [Setting a Tray to Print Received Documents \(Advanced Manual\)](#)
- [Setting the Waiting Time from When an Incoming Call Arrives to When Reception Starts \(Response Waiting Time\)](#)
- [Setting a Print Method for When a Received Image Exceeds Paper Size \(Advanced Manual\)](#)
- [Duplex Printing \(Advanced Manual\)](#)
- [Setting So That You Can Hear Line Monitor Sound \(Advanced Manual\)](#)
- [Forwarding a Fax to Another Fax Number \(Advanced Manual\)](#)
- [Setting When to Ring the External Telephone \(Tel Priority Mode\) \(Advanced Manual\)](#)
- [Setting Fax Detection Mode \(Advanced Manual\)](#)
- [Setting the T/F Timer \(Advanced Manual\)](#)
- [Setting TAD Mode \(Advanced Manual\)](#)
- [Block Junk Fax \(Advanced Manual\)](#)

Setting the Reception Mode



[Fax Ready Mode] is set by factory default.

Change the setting according to your environment.

- [Fax Ready Mode] : Select this mode if you use this machine for fax only.
- [Tel/Fax Ready Mode] : Select this mode if you want to receive both phone calls and faxes with the machine detecting automatically.
- [Ans/Fax Ready Mode] : Select this mode if you want to use the answering phone function of an external telephone as well as the fax function of the machine.
- [Tel Ready Mode] : Select this mode if you often use the external telephone that is connected to the machine.
- [DRD] : If you use the distinctive ring detection (DRD) function that is provided by a telephone company. Refer to "DRD".

- 1 Check that the machine is turned on.
- 2 Press the  (SETTING) button on the operator panel.





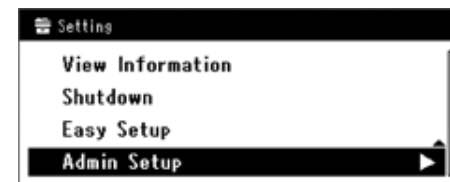





- 3 Press the  button to select [Admin Setup] and press the  (OK) button.



- 4 Enter the administrator password.



The factory default administrator name and password are "admin" and "999999" respectively.

- 5 Select [Enter], and then press the  (OK) button.
- 6 Press the  button to select [User Install], and then press the  (OK) button.
- 7 Press the  button to select [Reception Mode], and then press the  (OK) button.
- 8 Press the  button to select a reception mode, and then press the  (OK) button.
- 9 Press the  button until the top screen is displayed.

DRD

This mode allows the machine to detect a distinctive ring if it has been enabled on the phone line. In this mode, the machine distinguishes the DRD type of the sender. The machine then answers only when it matches the registered DRD type.

There are several type of DRD ring pattern. The length of ring ON time and ring OFF time is different. It depends on the Country Code. Please set the Country Code and DRD Type for your suitable DRD ring pattern. You can register up to four DRD types.

Country Code : except New Zealand, Australia and Hong Kong (This pattern is to apply to America's DRD.)

Type 1 : 2 sec ON - 4 sec OFF repeat

Type 2 : 0.8 sec ON - 0.4 sec OFF - 0.8 sec ON - 4 sec OFF repeat

Type 3 : 0.4 sec ON - 0.2 sec OFF - 0.4 sec ON - 0.2 sec OFF - 0.8 sec ON - 4 sec OFF repeat

Type 4 : 0.3 sec ON - 0.2 sec OFF - 1 sec ON - 0.2 sec OFF - 0.3 sec ON - 4 sec OFF repeat

Country Code : New Zealand (This pattern is to apply to New Zealand's DRD.)

Type 1 : 0.4 sec ON - 0.2 sec OFF - 0.4 sec ON - 2 sec OFF repeat

Type 2 : 0.4 sec ON - 2.6 sec OFF repeat

Type 3 : 0.4 sec ON - 0.2 sec OFF - 0.4 sec ON - 0.2 sec OFF - 0.4 sec ON - 1.4 sec OFF repeat

Type 4 : 0.4 sec ON - 0.8 sec OFF - 0.4 sec ON - 1.4 sec OFF repeat

Country Code : Australia (This pattern is to apply to Australia's DRD.)

Type 1 : 0.4 sec ON - 0.2 sec OFF - 0.4 sec ON - 2 sec OFF repeat

Type 2 : 0.2 sec ON - 0.4 sec OFF - 0.2 sec ON - 0.4 sec OFF - 0.2 sec ON - 1.6 sec OFF repeat

Country Code : Hong Kong (This pattern is to apply to Hong Kong's DRD.)

Type 1 : 1.2 sec ON - 3 sec OFF repeat



Type 2 : 0.4 sec ON - 0.2 sec OFF - 0.4 sec ON - 0.2 sec OFF - 0.8 sec ON - 0.4 sec OFF repeat

Type 3 : 0.5 sec ON - 0.5 sec OFF - 1 sec ON - 0.5 sec OFF - 0.5 sec ON - 3 sec OFF repeat

Setting the Waiting Time from When an Incoming Call Arrives to When Reception Starts (Response Waiting Time)











The factory default value is 1 Ring.

Change the value if faxes cannot be received.

- 1 Press the  (SETTING) button on the operator panel.
- 2 Press the  button to select [Admin Setup] and press the  (OK) button.
- 3 Enter the administrator password.



The factory default administrator name and password are "admin" and "999999" respectively.

- 4 Select [Enter], and then press the  (OK) button.
- 5 Press the  button to select [Fax Setup], and then press the  (OK) button.
- 6 Press the  button to select [Other Settings], and then press the  (OK) button.
- 7 Press the  button to select [Ring Response], and then press the  (OK) button.
- 8 Press the  button to select a waiting time, and then press the  (OK) button.
- 9 Press the  button until the top screen is displayed.

8

Maintenance

Replacing Consumables

Cleaning Each Part of the Machine

This section describes how to maintain the machine to keep the machine comfortable and extend its life.





Replacing Consumables







This section describes how to replace consumables.





- [Cautions When Replacing Consumables](#)
- [Replacing the Toner Cartridges](#)
- [Replacing the Image Drum](#)
- [Replacing the Image Drum and Toner Cartridge at the Same Time](#)

Cautions When Replacing Consumables

Observe the following cautions when replacing.

 WARNING	
	Do not throw the toner or toner cartridge into a fire. The toner will scatter, resulting in burns.
	Do not store a toner cartridge in a location where it is exposed to open flames. The toner may ignite, resulting in fire or burns.
	Do not vacuum spilled toner with an electric vacuum cleaner. Vacuuming spilled toner with an electric vacuum cleaner may result in ignition due to sparks from electric contacts or other reasons. If toner spills on the floor or other places, wipe the toner with a damp rag or other cloth.

 CAUTION	
	Some parts inside the machine become very hot. Do not touch the locations around a "CAUTION HOT" label. Burns may result.
	Keep toner cartridges out of the reach of children. If a child accidentally swallows toner, immediately seek medical advice.
	If you inhale toner, gargle with a large amount of water, and move to a place with fresh air. Seek medical advice if necessary.
	If toner lands on your hands or other areas of skin, wash thoroughly with soap and water.
	If toner gets into your eyes, immediately rinse with a large amount of water. Seek medical advice if necessary.

 CAUTION	
	If you swallow toner, spit it out. Seek medical advice if necessary.
	When handling a paper jam or replacing toner cartridges, use care not to let your clothes or hands get dirty with toner. If toner lands on your clothes, wash with cold water. If toner gets hot by washing with hot water or other methods, the toner will stain the fabric and become impossible to remove.
	Do not disassemble the image drum or toner cartridge. You may inhale the scattered toner, or the toner may land on your hands or clothes, making them dirty.
	Store used toner cartridges by putting them into a bag while using care not to scatter the toner.



- Use OKI genuine consumables to ensure optimum performance of the products.
- Charges for services for problems caused by the use of consumables other than OKI genuine consumables are incurred, regardless of the warranty or in the maintenance contract. (Although the use of non-genuine consumables does not always result in problems, use extra care when using them.)

Replacing the Toner Cartridges

When the "[COLOR] Toner Low" message ("[COLOR]" indicates C (cyan), M (magenta), Y (yellow) or K (black)) which appears on the display screen, prepare a replacement toner cartridge.

When the "[COLOR] Toner Empty" appears and printing stops, replace the toner cartridge.



Even if the cyan (blue), magenta (red) or yellow toner cartridges run out, you can print in black and white by selecting [Monochrome] or [Grayscale]. However, please replace the toner cartridge quickly after it runs out, as not doing so may cause the image drum to be damaged.



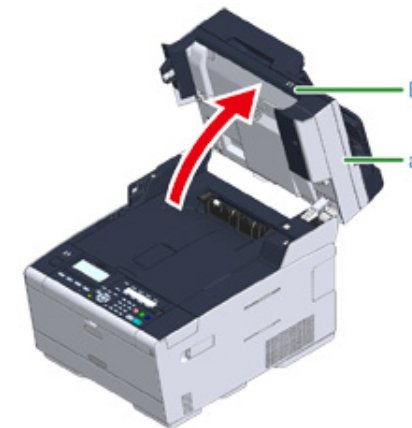

- Have a new toner cartridge ready, as the print quality declines after more than one year following breaking the seal.
- If you replace the toner cartridge/image drum while it is being used, the toner consumption will not be counted normally.
- By opening and closing the output tray after the message "[COLOR] toner has run out" is displayed, you are able to print. Please replace the toner cartridge as failure to do so may damage the image drum.
- Toner powder may spill if you remove a toner cartridge before the toner runs out.

- 1 Prepare new toner cartridges.
- 2 Hold the handle (B) and open the scanner unit (a) completely.



- 3 Press the button (A) and open the output tray (b) completely.

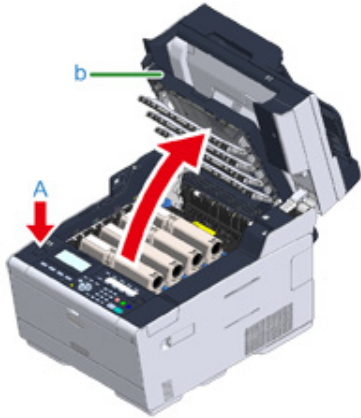

 CAUTION	Burns may result.	
The fuser unit is extremely hot. Do not touch it.		



- 4 Identify an empty toner cartridge by its label color.
- 5 Pinch the tip of blue lever (c) of the toner cartridge and turn it toward you until the tip aligns on the lug of the cartridge.



- 6 Lift the toner cartridge (d) from right side, and remove it from the machine.

 WARNING	Burns may result.	
Never throw used toner cartridges into a fire. They may explode, and the toner inside may fly off and cause burns.		



While removing consumables, be careful not to hit them to the LED head.

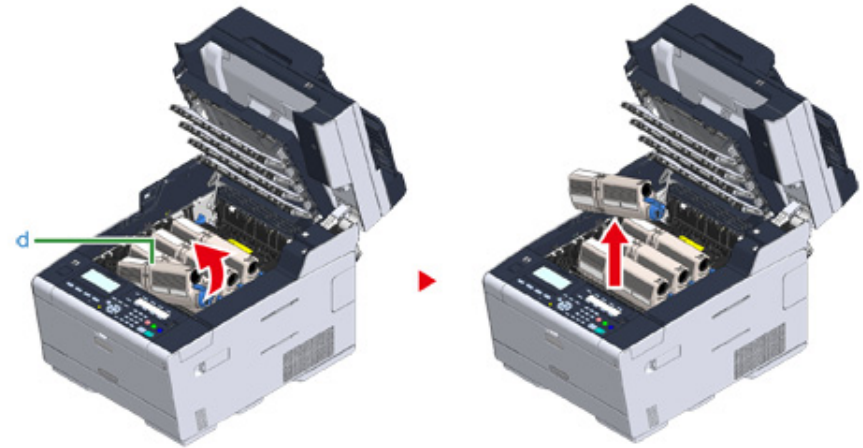

- 7 Unpack a new toner cartridge.

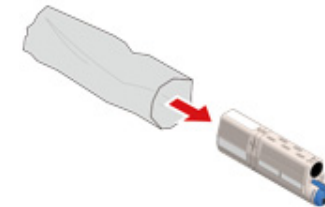

- 8 Shake the cartridge several times vertically and horizontally.

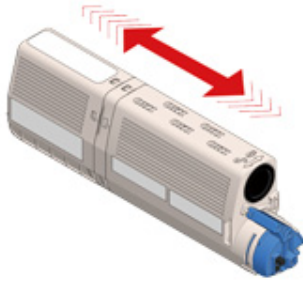

- 9 Remove the tape (e) from the toner cartridge.

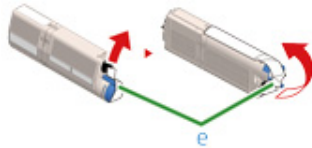

- 10 Insert a new toner cartridge (d) by aligning its left side indentation (f) with the protrusion (g) on the image drum so the toner cartridge and image drum color labels align. Then insert the right side gently into place.



Do not insert a toner cartridge without removing the tape.

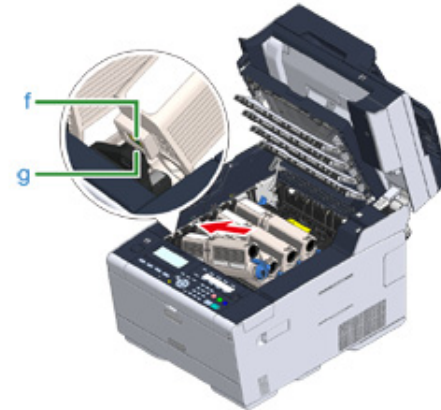

- 11** Hold the cartridge, pinch the tip of blue lever (c) of the toner cartridge, and turn forward until the tip aligns on the lug of the cartridge.

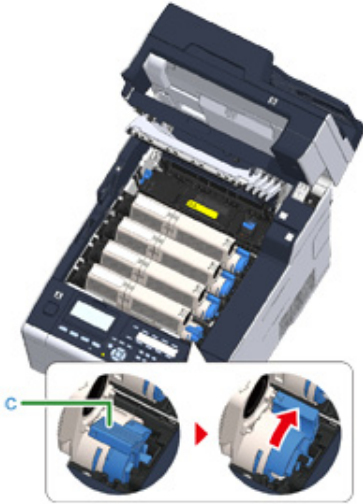

- If you close the output tray without turning the blue lever when installing the toner cartridge into the image drum, it may cause a malfunction. Be sure to turn the blue lever until its top aligns on the lug in the back of the toner cartridge.
- If the toner cartridge is not securely attached, printing quality may deteriorate.

- 12** Wipe the lens of the LED head with a soft tissue paper lightly.

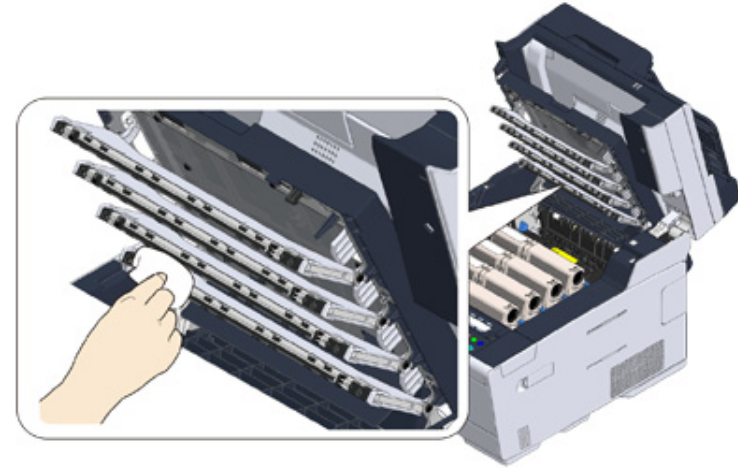

Do not use solvents, such as methyl alcohol or thinners. They damage the LED head.

- 13** Close the output tray (b) slowly and push the center of the output tray for confirmation.

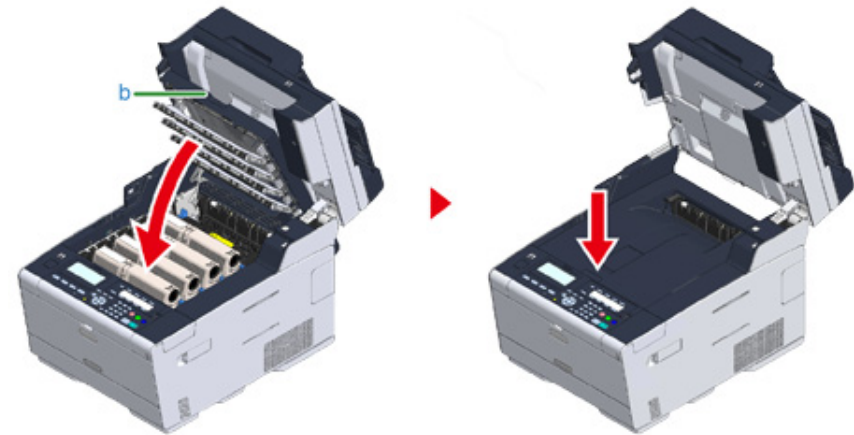

- 14** Hold the handle (B) to close the scanner unit (a).



Do not close the scanner unit vigorously. It may cause the document feed roller of ADF to fall and get in the way of loading documents.

If the document feed roller of ADF has fallen, open and close the ADF cover.

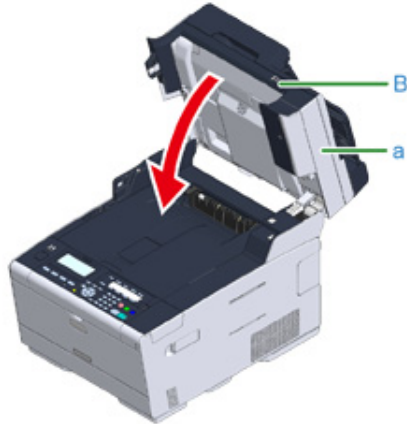

15 Please recycle toner cartridges.



If you have to dispose of used toner cartridges, put them into polyethylene bags or other container, and be sure to follow the regulations or instructions of your local government.

Replacing the Image Drum

When the "[COLOR] Image Drum Near Life" message appears on the display screen, prepare a replacement image drum. If you continue printing, the message "[COLOR] Image Drum Life" will be displayed and printing will stop.

When the "Please install new Image Drum Unit." message is displayed and printing stops, replace the image drum.

When using A4 paper (simplex printing), the estimated replacement cycle of an image drum is approximately 30,000 pages. This estimation assumes the standard use condition (three pages are printed at a time). Printing one page at a time reduces the drum lifetime approximately by half.

The actual number of printed pages may be less than half the above estimation depending on the printing conditions.



- The actual number of pages you can print with the image drum depends on how you use the machine. It may be less than half the above estimation depending on the printing conditions.
- Printing quality may deteriorate after 1 year following the unpacking of the toner cartridge. Replace the toner cartridge with a new one.
- Although opening and closing the output tray may extend the life of an image drum for a while, it is recommended to replace it soon after the "Install New image drum" message is displayed.
- When pressing the  (SETTING) button > [Admin Setup] > [Manage Unit] > [System Setup] > [Near Life Status] on the operator panel is set to [Disable], the "[COLOR] Image Drum Near Life" message does not appear.
- Use OKI genuine consumables to ensure optimum performance of the products.
- Charges for services for problems caused by the use of consumables other than OKI genuine consumables are incurred, regardless of the warranty or in the maintenance contract. (Although use of non-genuine consumables does not always result in problems, use extra care when using them.)

This section describes how to replace the image drum when you want to continue using the toner cartridge.



- If you use a new image drum with the toner cartridges currently in use, the remaining amount indication of the toner cartridges will not display correctly. The messages "[COLOR] Image Drum Near Life" or "[COLOR] Image Drum Life" may also be displayed soon after replacement.
- Use extra care when handling the image drum (the green cylinder), because it is fragile.
- Do not expose the image drum to direct sunlight or strong light (approximately 1,500 lux or more). Even under room lighting, do not leave the image drum for 5 minutes or more.



You can set when to display the "[COLOR] Image Drum Near Life" message. Press the  (SETTING) button > [Admin Setup] > [User Install] > [Drum Near Life Timing] on the operator panel to change the setting. Available values are from 500 to 3,000 (in 500 increments).

- 1 Prepare new image drum.
- 2 Hold the handle (B) and open the scanner unit (a) completely.

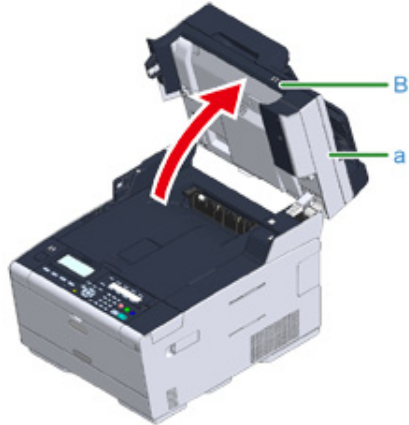

- 3 Press the button (A) and open the output tray (b) completely.

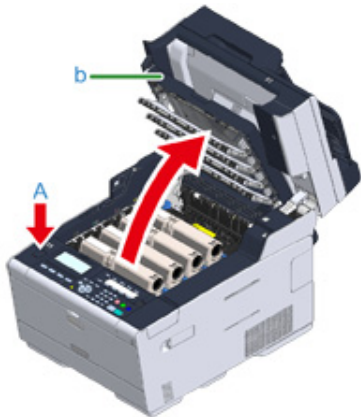

- 4 Identify the image drum that reached its lifetime by its label color.

- 5 Remove the image drum (c) from the machine and place the image drum on a flat surface.



While removing consumables, be careful not to hit them to the LED head.

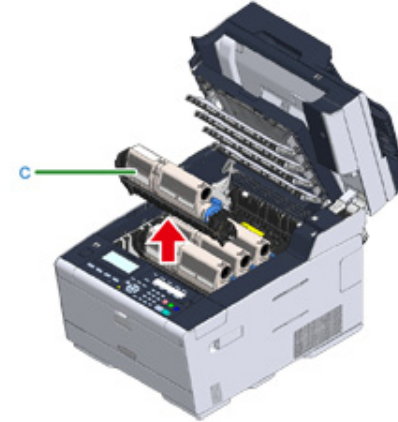

- 6 Hold the cartridge, pinch the tip of blue lever (d) of the toner cartridge, and turn it toward you until the tip aligns on the lug of the cartridge.

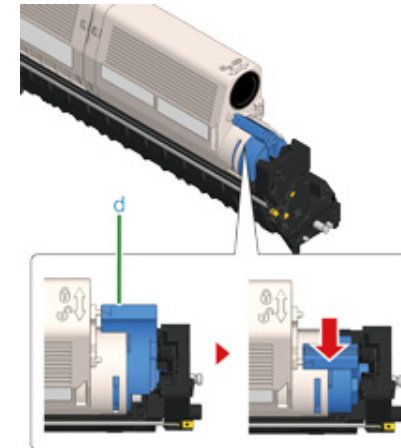

- 7** Lift the toner cartridge (e) from the right side, and remove it from the image drum.

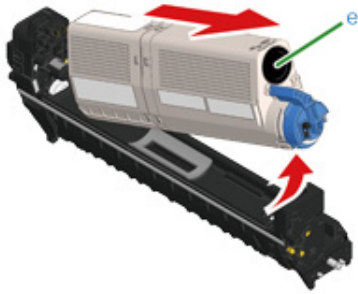

- 8** Unpack a new image drum and place it on a flat surface.

- 9** Remove the desiccant pack.

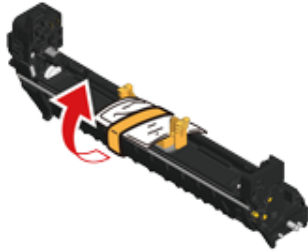

- 10** Remove the toner cover.

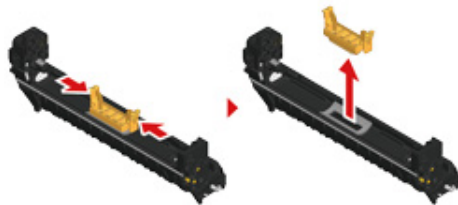

- 11** Insert the toner cartridge (e) removed in step 7 by aligning its left side indentation (f) with the protrusion (g) on the image drum so that the toner

cartridge and image drum color label align. Then insert the right side gently into place.

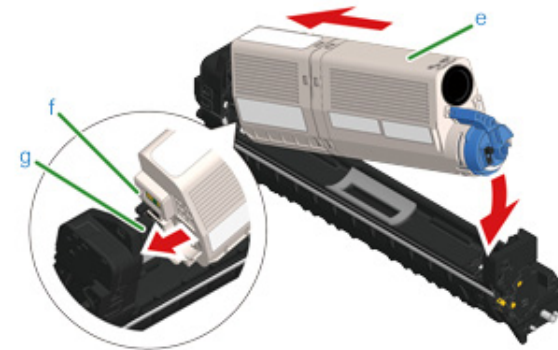

- 12** Hold the cartridge, pinch the tip of blue lever (d) of the toner cartridge, and turn forward until the tip aligns on the lug of the cartridge.

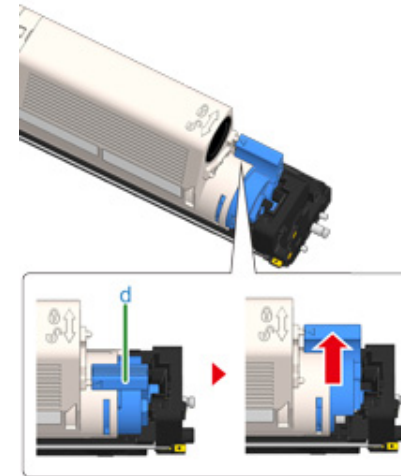

If you close the output tray without turning the blue lever when installing the toner cartridge into the image drum, it may cause a malfunction. Be sure to turn the blue lever until its top aligns on the lug in the back of the toner cartridge.

- 13** Check the label color of the new image drum and place the drum into the machine.

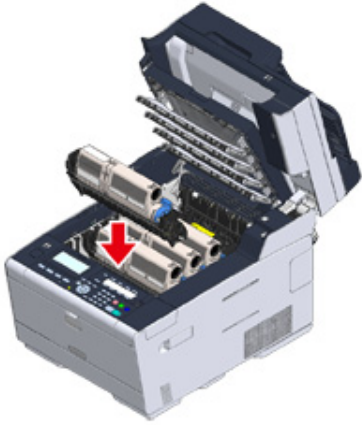

- 14** Close the output tray (b) slowly and push the center of the output tray for confirmation.

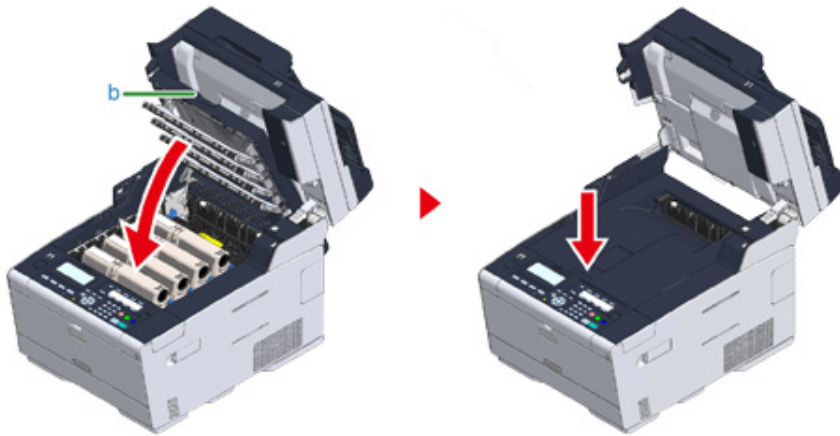

- 15** Hold the handle (B) to close the scanner unit (a).



Do not close the scanner unit vigorously. It may cause the document feed roller of ADF to fall and get in the way of loading documents.

If the document feed roller of ADF has fallen, open and close the ADF cover.

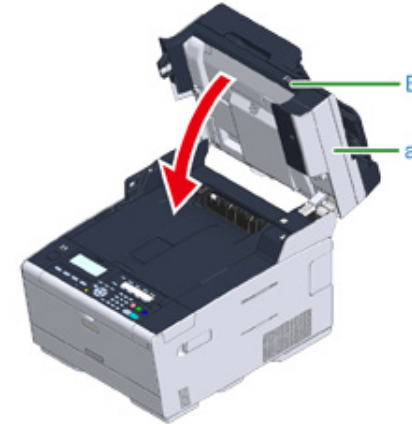

- 16** Please recycle image drums.



If you must dispose of an image drum, put it in a plastic bag or similar container and dispose of it in accordance with your municipality's ordinances or guidelines.

Replacing the Image Drum and Toner Cartridge at the Same Time

This section describes how to replace the image drum and toner cartridge with new ones at the same time.



- Use extra care when handling the image drum (the green cylinder), because it is fragile.
- Do not expose the image drum to direct sunlight or strong light (approximately 1,500 lux or more). Do not leave the image drum for 5 minutes or more even under room light.

1 Prepare new image drum and toner cartridge.

2 Hold the handle (B) and open the scanner unit (a) completely.

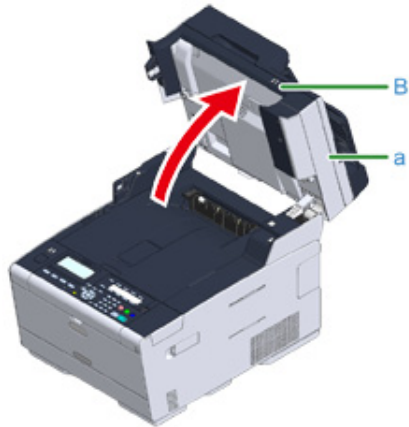

3 Press the button (A) and open the output tray (b) completely.

CAUTION

Burns may result.



The fuser unit is extremely hot. Do not touch it.

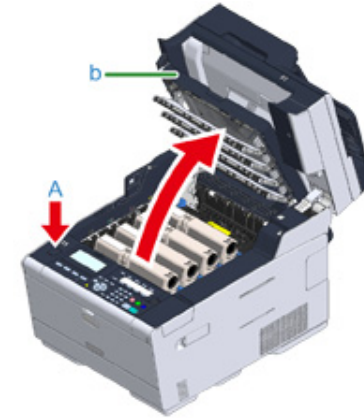

4 Identify an empty toner cartridge by its label color.

5 Remove the image drum (c) from the machine and place it on a flat surface.



While removing consumables, be careful not to hit them to the LED head.

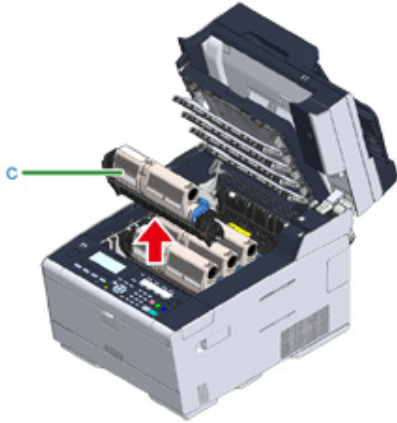

WARNING

Burns may result.



Never throw a used image drum or toner cartridge into a fire. They may explode, and the toner inside may fly off and cause burns.

6 Unpack a new image drum and place it on the flat surface.

7 Remove the desiccant pack.

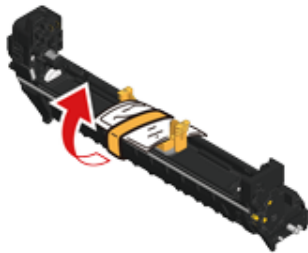

8 Remove the toner cover.

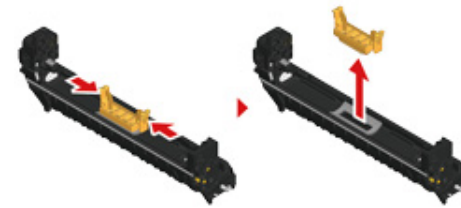

9 Unpack a new toner cartridge.

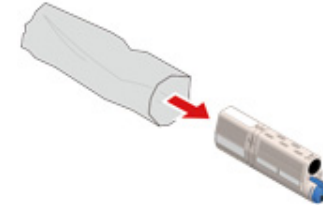

10 Shake the cartridge several times vertically and horizontally.

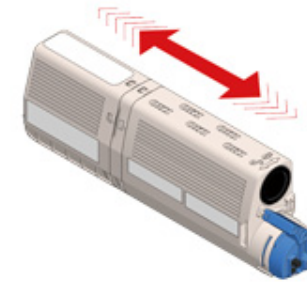

11 Remove the tape (d) from the toner cartridge.

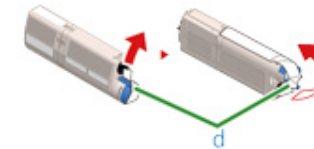

- 12** Insert a new toner cartridge (e) by aligning its left side indentation (f) with the protrusion (g) on the image drum so that the toner cartridge and image drum color label align. Then insert the right side gently into place.

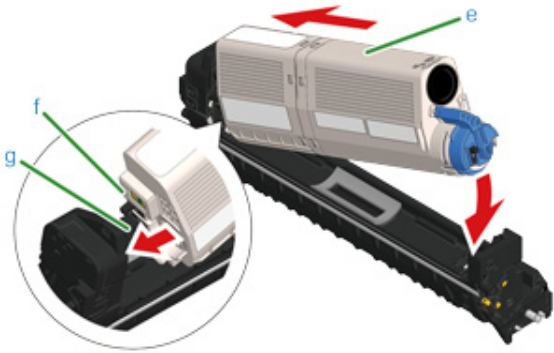

For the installation method, refer to "Replacing the Toner Cartridges".

- 13** Hold the cartridge, pinch the tip of blue lever (h) of the toner cartridge, and turn forward until the tip aligns on the lug of the cartridge.

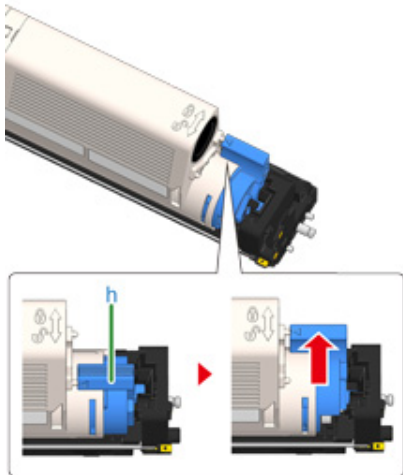

If you close the output tray without turning the blue lever when installing the toner cartridge into the image drum, it may cause a malfunction. Be sure to turn the blue lever until its top aligns on the lug in the back of the toner cartridge.

- 14** Check a label color of a new image drum and place the drum into the machine.



- 15** Close the output tray (b) slowly and push the center of the output tray for confirmation.

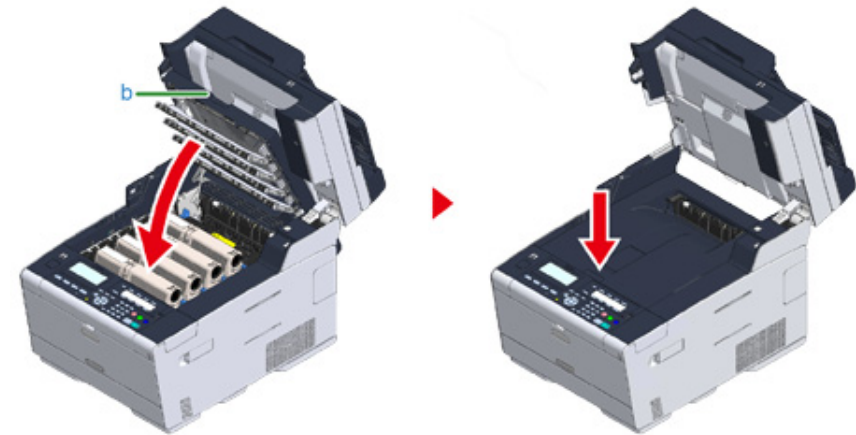

- 16** Hold the handle (B) to close the scanner unit (a).



Do not close the scanner unit vigorously. It may cause the document feed roller of ADF to fall and get in the way of loading documents.

If the document feed roller of ADF has fallen, open and close the ADF cover.

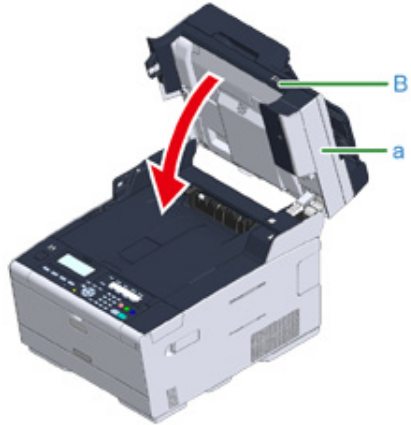

17 Please recycle image drums and toner cartridges.



If you must dispose of an image drum, put it in a plastic bag or similar container and dispose of it in accordance with your municipality's ordinances or guidelines.

Cleaning Each Part of the Machine

This section describes how to clean the machine and parts.

- Cleaning the Surface of the Machine (Advanced Manual)
- [Cleaning the Document Glass](#)
- Cleaning the Document Feed Rollers (Advanced Manual)
- Cleaning the Paper Feed Rollers (Tray 1/Tray 2/Tray 3 (Except MC363)) (Advanced Manual)
- Cleaning the Paper Feed Rollers (MP Tray) (Advanced Manual)
- [Cleaning the LED Head](#)

Cleaning the Document Glass

Clean the document glass once a month to maintain image quality of the printouts.



Do not use benzene, thinners, or alcohol. They may damage the plastic parts of the machine.

- 1 Open the document glass cover.



- 2 Wipe lightly the document holding pad (a) and document glass (b) with a soft cloth that has been slightly moistened with water and squeezed well.





If the document glass surface and document holding pad are very dirty, wipe gently with a soft cloth that has been moistened with neutral detergent and squeezed well, and then wipe again with a soft cloth that has been slightly moistened with water and squeezed well.

3 Close the document glass cover.



Do not close the document cover vigorously. It may cause the document feed roller of ADF to fall and get in the way of loading documents.

If the document feed roller of ADF has fallen, open and close the ADF cover.



Cleaning the LED Head

Clean the LED head if vertical white lines appear, images are faded, or the periphery of letters are smudged in the printouts.



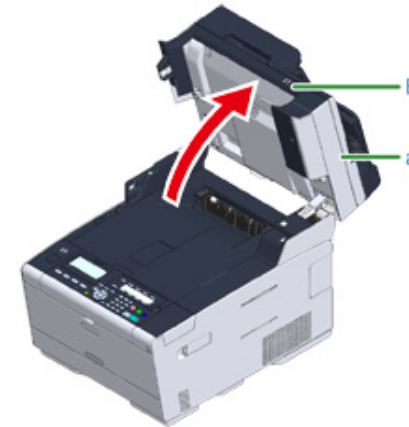

- Do not use solvents, such as methyl alcohol or thinners, because they may damage the LED head.
- Do not expose the image drum to direct sunlight or strong light (approximately 1,500 lux or more). Even under room lighting, do not leave the image drum for 5 minutes or more.

1 Hold the handle (B) and open the scanner unit (a) completely.



- 2 Press the button (A) and open the output tray (b) completely.

 CAUTION	Burns may result.	
The fuser unit is extremely hot. Do not touch it.		

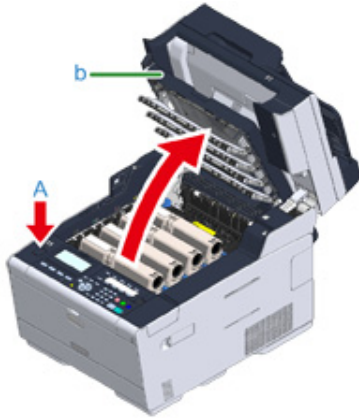

- 3 Wipe the four lenses of the LED heads with a soft tissue paper lightly.

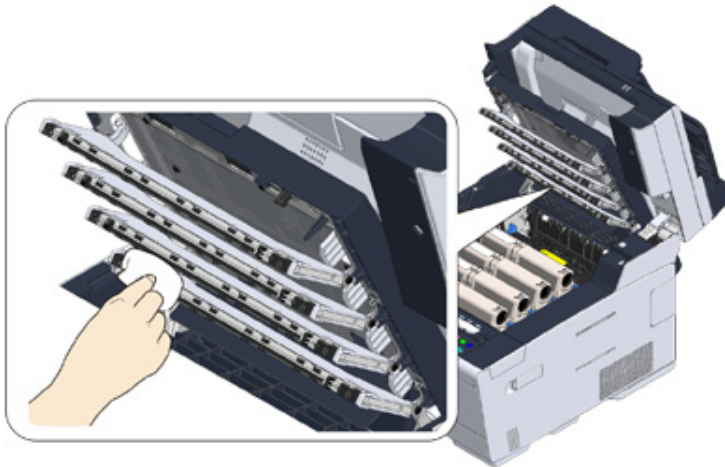

- 4 Close the output tray (b) slowly and push the center of the output tray for confirmation.

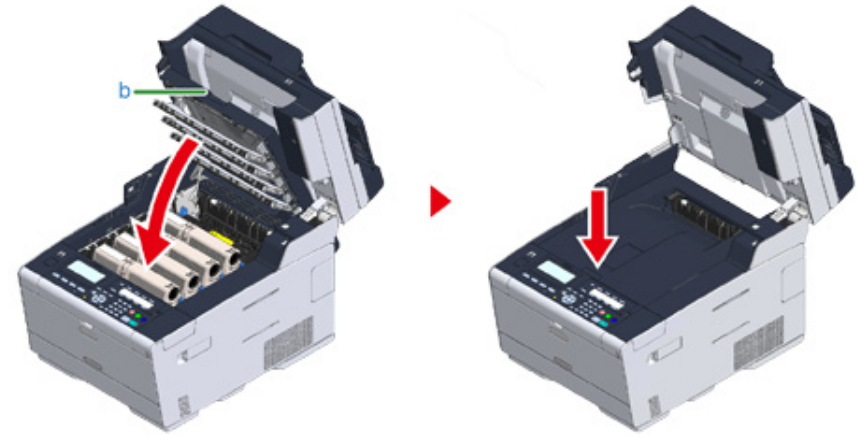

- 5 Hold the handle (B) to close the scanner unit (a).



Do not close the scanner unit vigorously. It may cause the document feed roller of ADF to fall and get in the way of loading documents.

If the document feed roller of ADF has fallen, open and close the ADF cover.

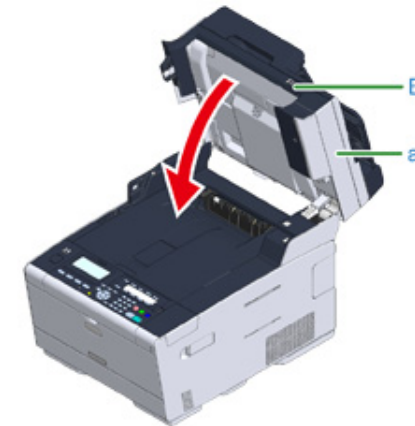

9

Troubleshooting

If Paper Jams Occur

If a Document Jam Occurs

Copy Problems

Scan Problems

Print Problems

Fax Problems

If an Error Message is Displayed on the Operator Panel

If Paper Jams Occur

This section describes how to handle when a paper jam occurs. Check the error code on the operator panel and see the corresponding page.

- If the Error Code is "370", "371", "372"
- If the Error Code is "380", "381", "382", "385", "389"
- If the Error Code is "390"
- If the Error Code is "391", "392", "393"
- If the Error Code is "409"

If the Error Code is "370", "371", "372"



- 1 If documents are set in the ADF or on the document glass, remove them.

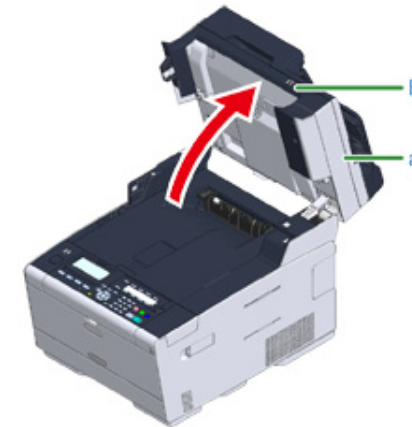

- 2 Hold the handle (B) and open the scanner unit (a) completely.



- 3 Press the button (A) and open the output tray (b) completely.

 CAUTION	Burns may result.	
The fuser unit is extremely hot. Do not touch it.		

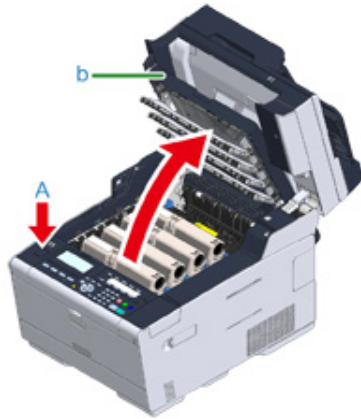

- 4 Remove the four image drums from the machine and place the image drums on a flat surface.



While removing consumables, be careful not to hit them to the LED head.

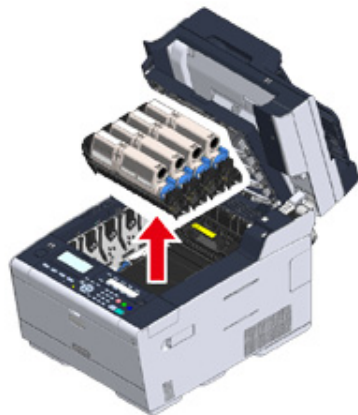

- 5 Cover the removed image drums with paper so that the image drums are not exposed to light.

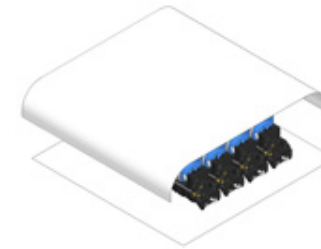

- 6 Remove the jammed paper slowly by pulling the edge of paper.



- 7 If paper jams in the fuser unit, press the jam release lever (c) on the fuser unit and slowly pull the jammed paper toward you.

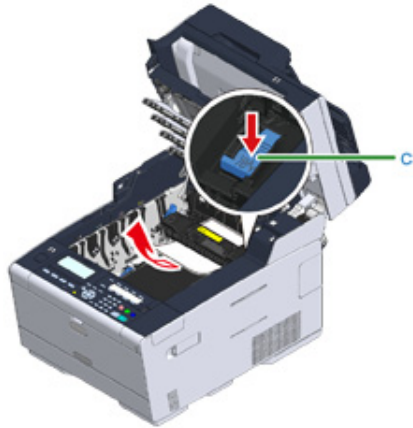

- 8 Tilt back the lock levers (d) on the both sides of the fuser unit toward you.

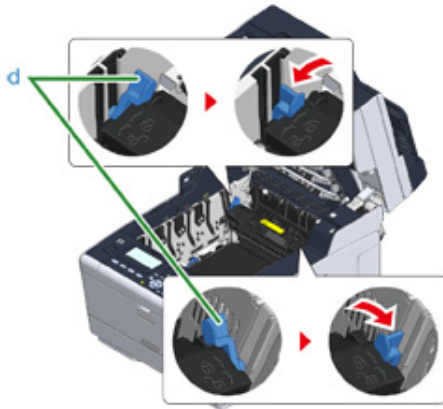

- 9 Hold the fuser unit handle and lift the fuser unit out of the machine.



- 10** Turn the lock levers (e) on the both sides of the belt unit toward you and remove the belt unit by holding the lock levers.

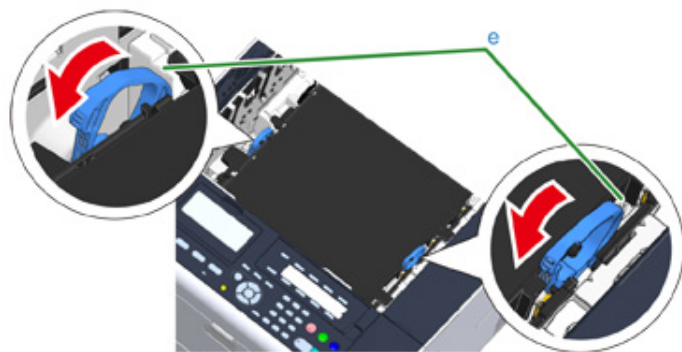

- 11** Remove the jammed paper slowly by pulling the edge of paper.



- 12** Hold the lock levers of belt unit and place the belt unit into the machine.

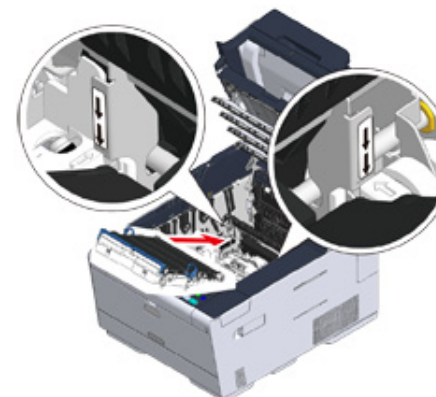

- 13** Turn the lock levers (e) on the both sides of the belt unit forward.

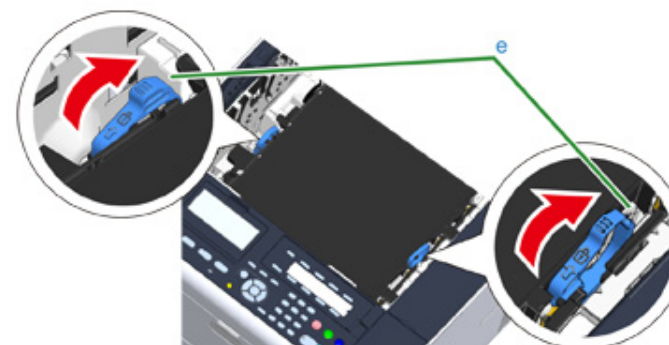

- 14** Hold the fuser unit handle and place the fuser unit into the machine.

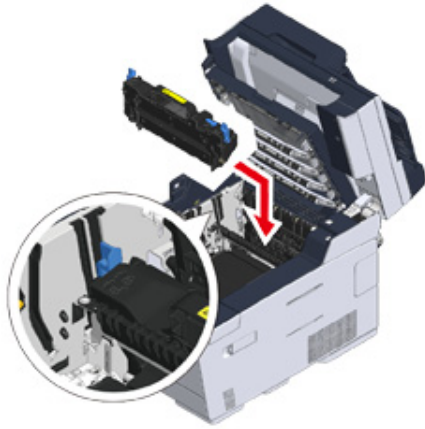

- 15** Tilt the lock levers (c) on the both sides of the fuser unit.

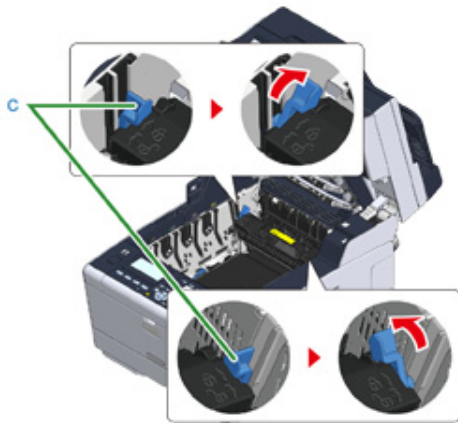

- 16** Replace the four image drums into the machine

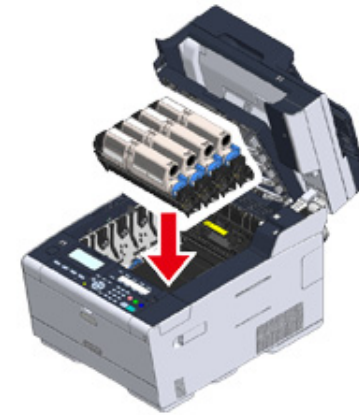

- 17** Close the output tray (b) slowly and push the center of the output tray for confirmation.

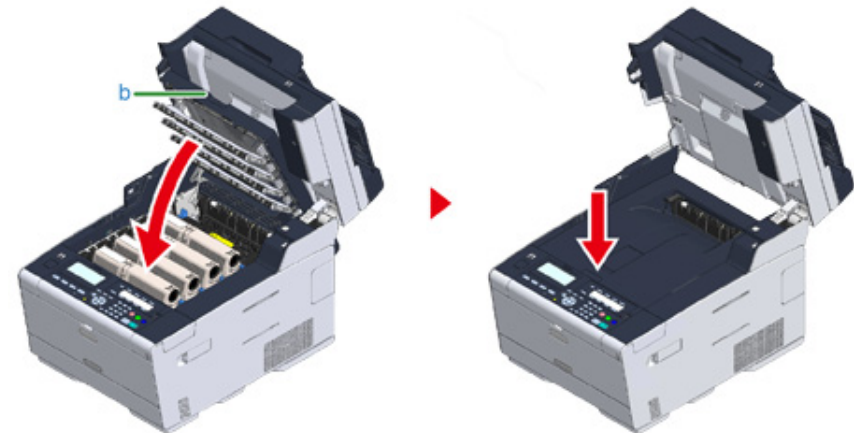

- 18** Hold the handle (B) to close the scanner unit (a).



Do not close the scanner unit vigorously. It may cause the document feed roller of ADF to fall and get in the way of loading documents.

If the document feed roller of ADF has fallen, open and close the ADF cover.

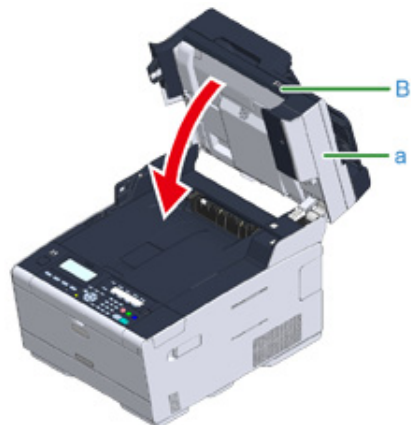

If the Error Code is "380", "381", "382", "385", "389"



1 If documents are set in the ADF or on the document glass, remove them.

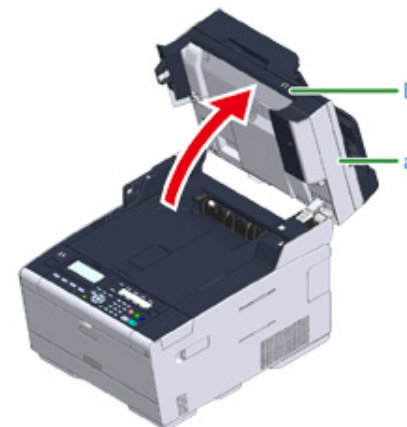

2 Hold the handle (B) and open the scanner unit (a) completely.



- 3 Press the button (A) and open the output tray (b) completely.

 CAUTION	Burns may result.	
The fuser unit is extremely hot. Do not touch it.		

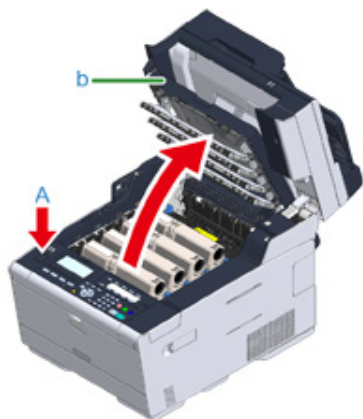

- 4 Remove the four image drums from the machine and place the image drums on a flat surface.



While removing consumables, be careful not to hit them to the LED head.

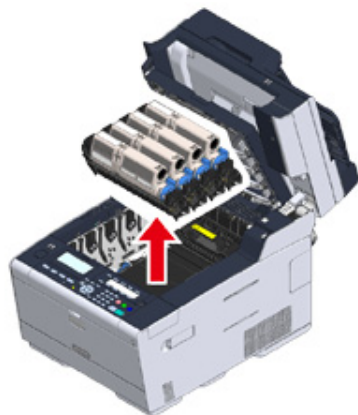

- 5 Cover the removed image drums with paper so that the image drums are not exposed to light.

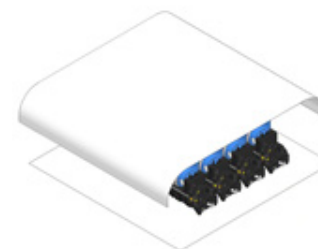

- 6 Remove the jammed paper slowly by pulling the edge of paper.



- 7 If paper jams in the fuser unit, press the jam release lever (c) on the fuser unit and slowly pull the jammed paper toward you.

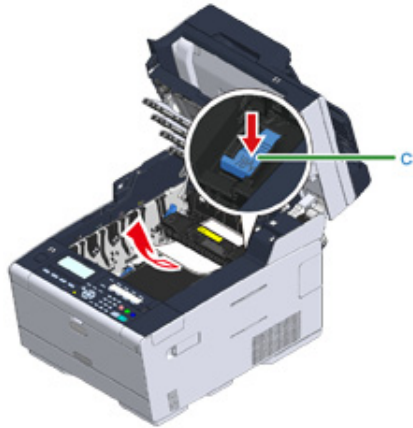

- 8 Tilt back the lock levers (d) on the both sides of the fuser unit toward you.

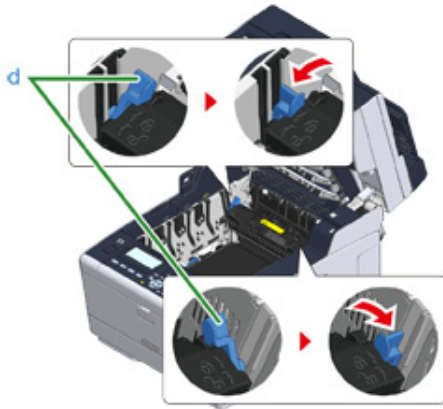

- 9 Hold the fuser unit handle and lift the fuser unit out of the machine.



- 10 Check that any pieces of paper do not remain inside the machine.



- 11** Hold the fuser unit handle and place the fuser unit into the machine.

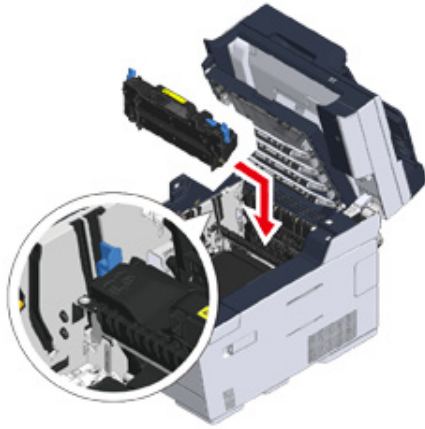

- 12** Tilt the lock levers (d) on the both sides of the fuser unit.

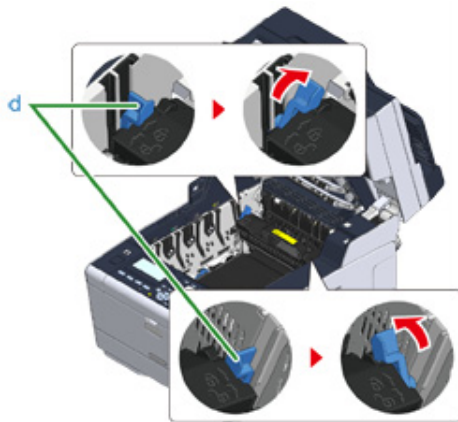

- 13** Put all four image drums back into the machine.

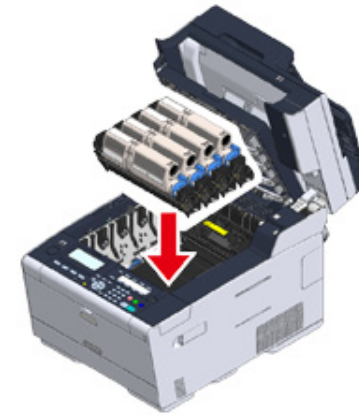

- 14** Close the output tray (b) slowly and push the center of the output tray for confirmation.

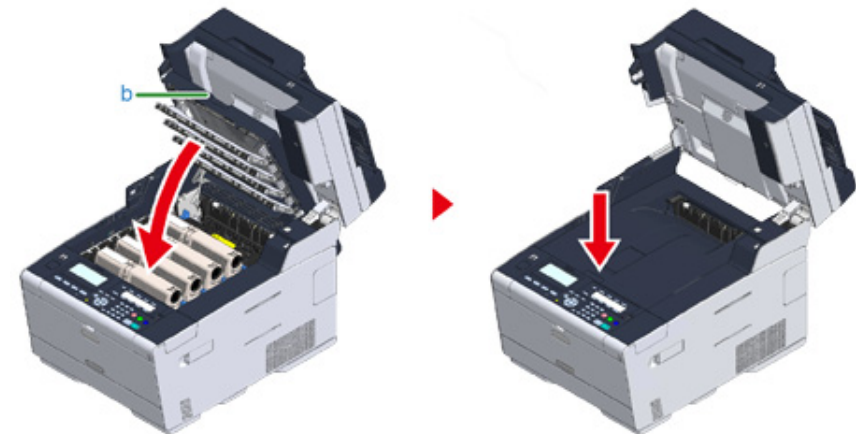

- 15** Hold the handle (B) to close the scanner unit (a).



Do not close the scanner unit vigorously. It may cause the document feed roller of ADF to fall and get in the way of loading documents.

If the document feed roller of ADF has fallen, open and close the ADF cover.

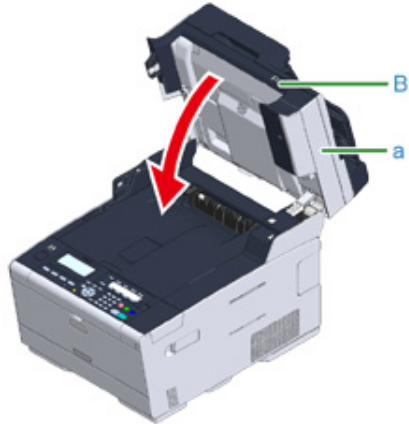

If the Error Code is "390"

- 1 If documents are set in the ADF or on the document glass, remove them.





- 2 If paper is loaded on the MP tray, remove the paper.

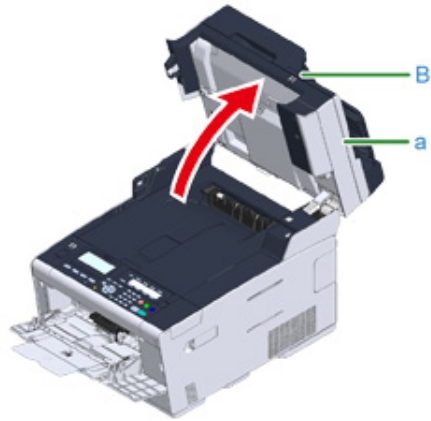

- 3 Hold the handle (B) and open the scanner unit (a) completely.



- 4 Press the button (A) and open the output tray (b) completely.

 CAUTION	Burns may result.	
The fuser unit is extremely hot. Do not touch it.		

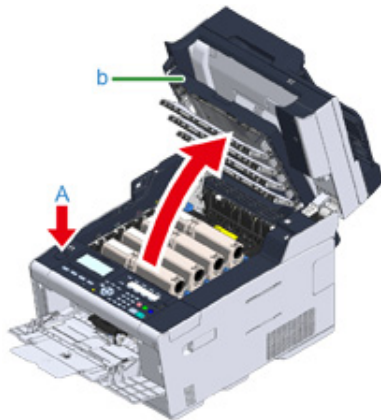

- 5 Remove the four image drums from the machine and place the image drums on a flat surface.



While removing consumables, be careful not to hit them to the LED head.

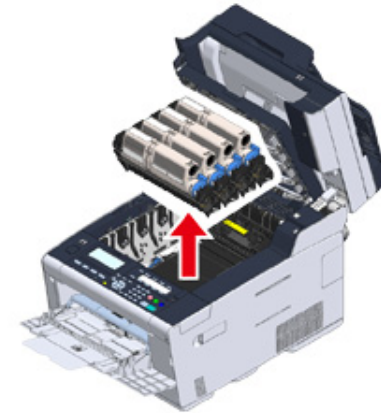

- 6 Cover the removed image drums with paper so that the image drums are not exposed to light.

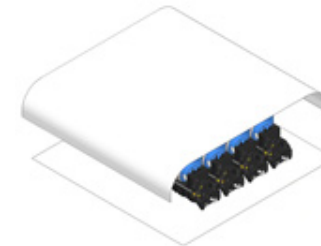

- 7 Open the transparent cover (c) inside the machine, remove the jammed paper slowly by pulling the edge of paper.

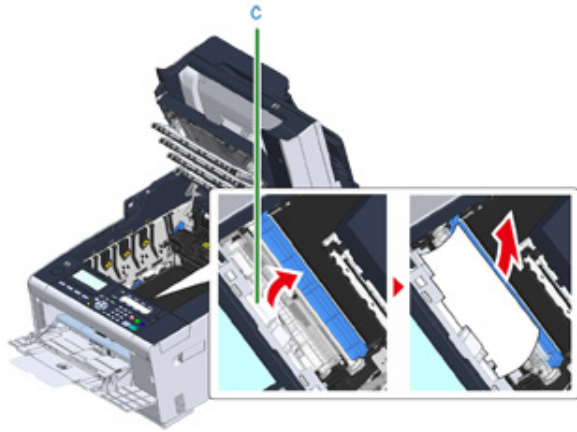

- 8 Put all four image drums back into the machine.

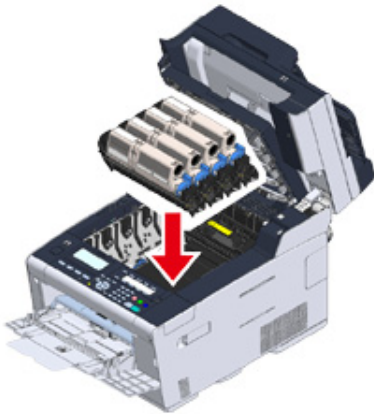

- 9 Close the output tray (b) slowly and push the center of the output tray for confirmation.

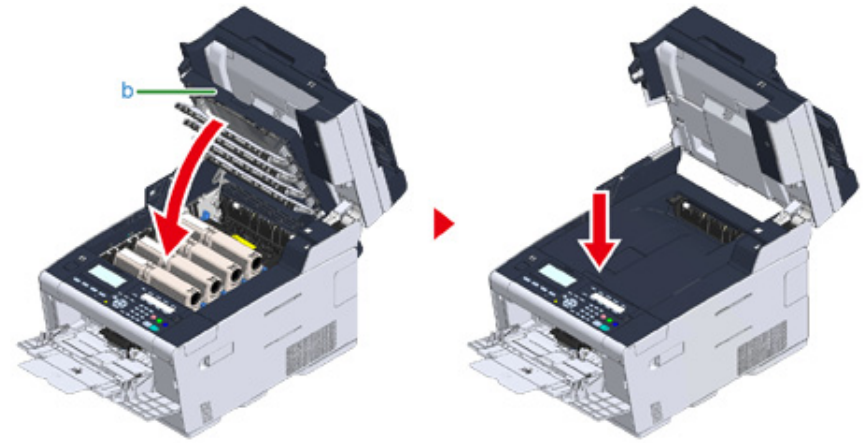

- 10 When loading paper on the MP tray, load the paper with the print side face up.



- 11 Hold the handle (B) to close the scanner unit (a).



Do not close the scanner unit vigorously. It may cause the document feed roller of ADF to fall and get in the way of loading documents.

If the document feed roller of ADF has fallen, open and close the ADF cover.

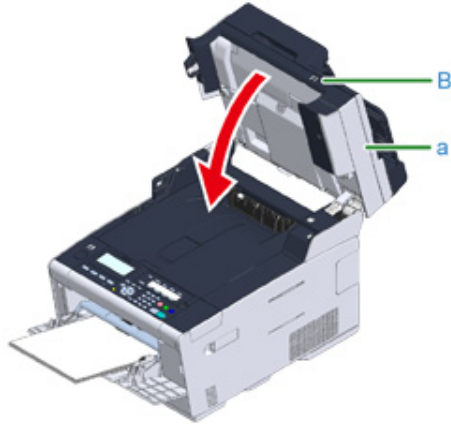

If the Error Code is "391", "392", "393"

A paper jam has occurred while feeding paper from a paper tray.



If paper jams occur frequently, clean the paper feed rollers. For details, refer to "Cleaning the Paper Feed Rollers (Tray 1/Tray 2/Tray 3 (Except MC363)) (Advanced Manual)".

This procedure uses Tray 1 as an example.

- 1 Pull out the cassette of the indicated tray.



- 2 Remove the jammed paper.





If jammed paper cannot be found, check the positions of the paper guides and paper stopper in the cassette and ensure that paper is correctly loaded.

- 3** Replace the paper cassette into the machine.



- 4** Hold the handle (B) and open the scanner unit (a) completely.

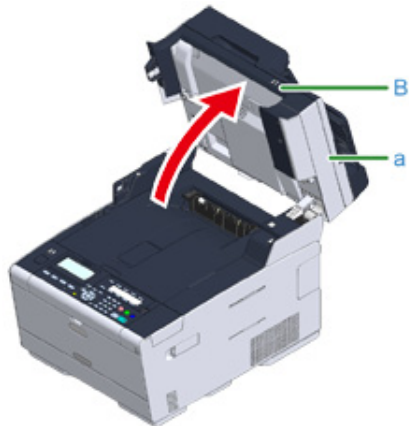

- 5** Press the button (A) and open the output tray (b) completely.

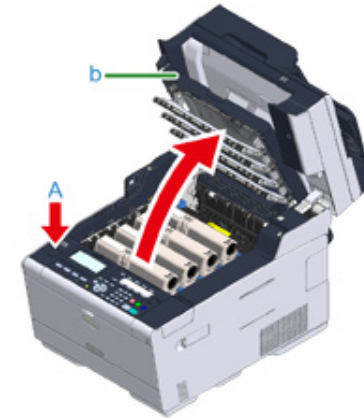

- 6** Close the output tray (b) slowly and push the center of the output tray for confirmation.

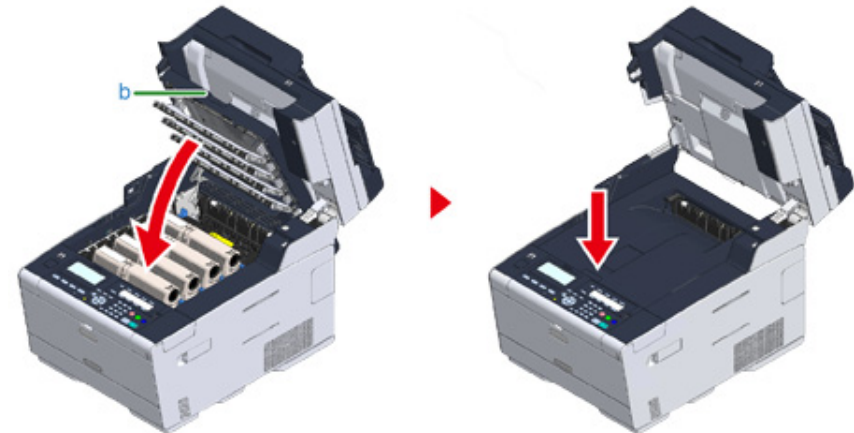

- 7 Hold the handle (B) and close the scanner unit (a).

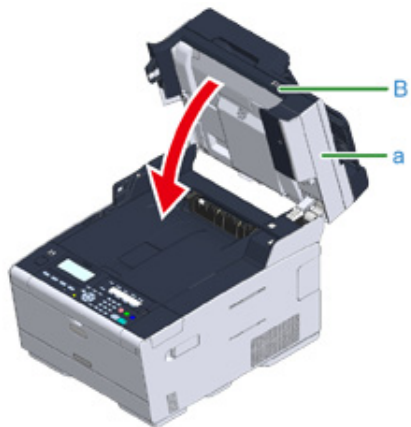

Do not close the scanner unit vigorously. It may cause the document feed roller of ADF to fall and get in the way of loading documents.

If the document feed roller of ADF has fallen, open and close the ADF cover.



Opening and closing the output tray starts printing.

If the Error Code is "409"

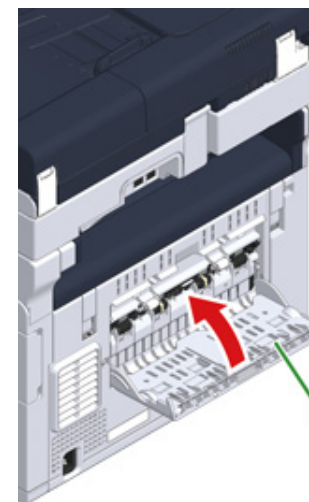

- 1 Close the rear output tray (b).



- 2 Hold the handle (B) and open the scanner unit (c) completely.



- 3 Press the button (A) and open the output tray (d) completely.

 CAUTION	Burns may result.	
The fuser unit is extremely hot. Do not touch it.		

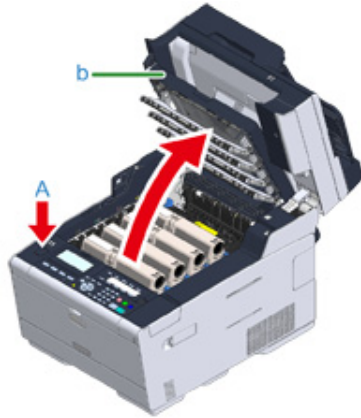

- 4 Remove the four image drums from the machine and place the image drums on a flat surface.



While removing consumables, be careful not to hit them to the LED head.

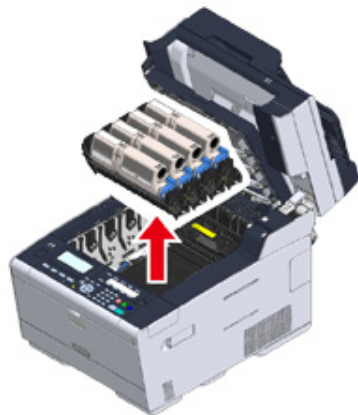

- 5 Cover the removed image drums with paper so that the image drums are not exposed to light.

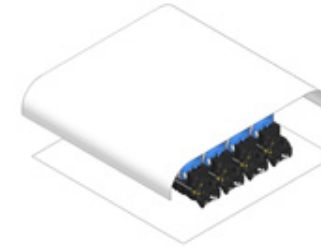

- 6 Remove the jammed paper slowly by pulling the edge of paper.



- 7 If paper jams in the fuser unit, press the jam release lever (e) on the fuser unit and slowly pull the jammed paper toward you.

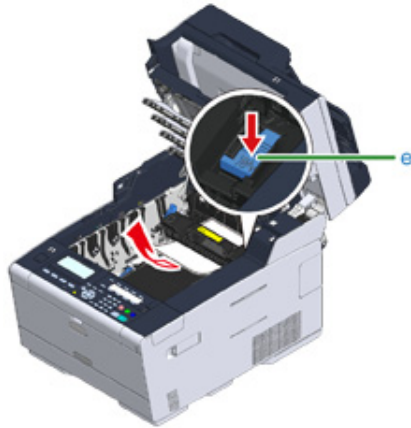

- 8 Tilt the lock levers (f) on the both sides of the fuser unit toward you.

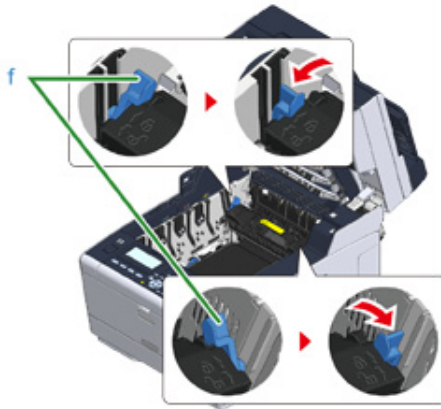

- 9 Hold the fuser unit handle and lift the fuser unit out of the machine.



- 10** Turn the lock levers (g) on the both sides of the belt unit toward you and remove the belt unit by holding the lock levers.

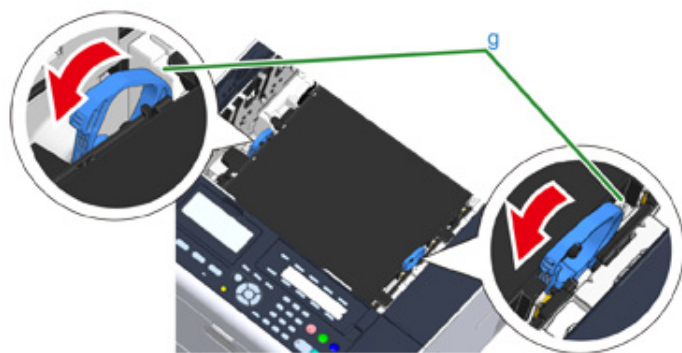

- 11** Remove the jammed paper slowly by pulling the edge of paper.

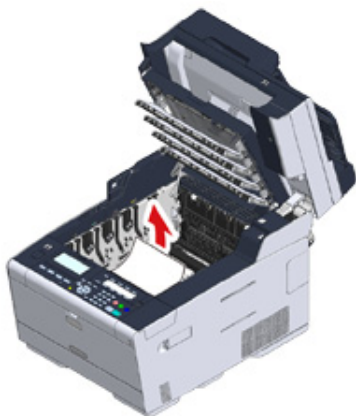

- 12** Hold the lock levers of belt unit and place the belt unit into the machine.

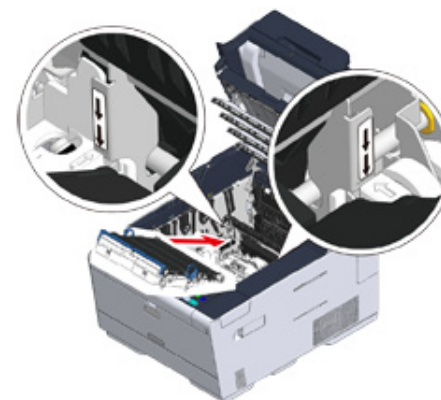

- 13** Turn the lock levers (g) on the both sides of the belt unit forward.

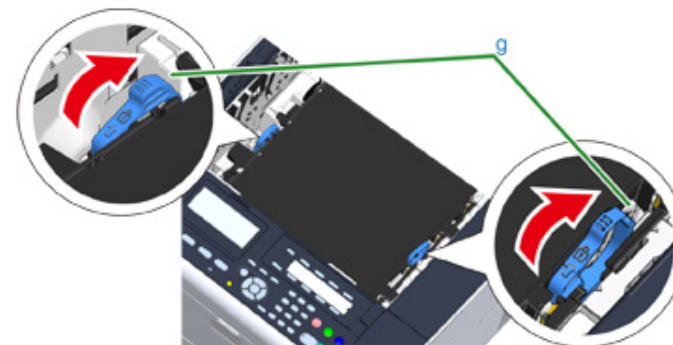

- 14** Hold the fuser unit handle and place the fuser unit into the machine.

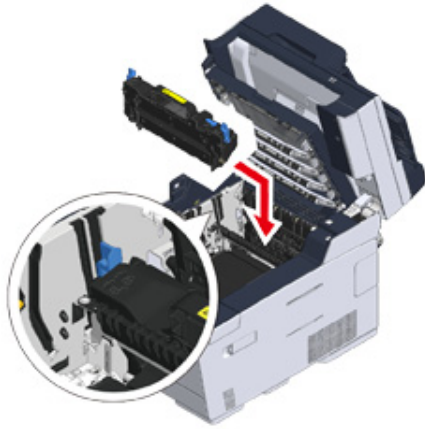

- 15** Tilt the lock levers (f) on the both sides of the fuser unit.

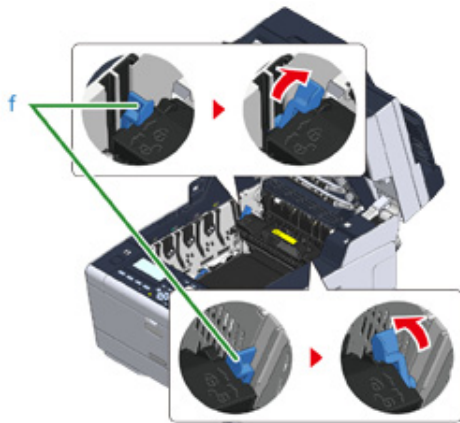

- 16** Put all four image drums back into the machine.

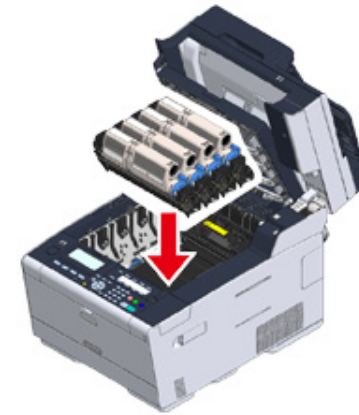

- 17** Close the output tray (b) slowly and push the center of the output tray for confirmation.

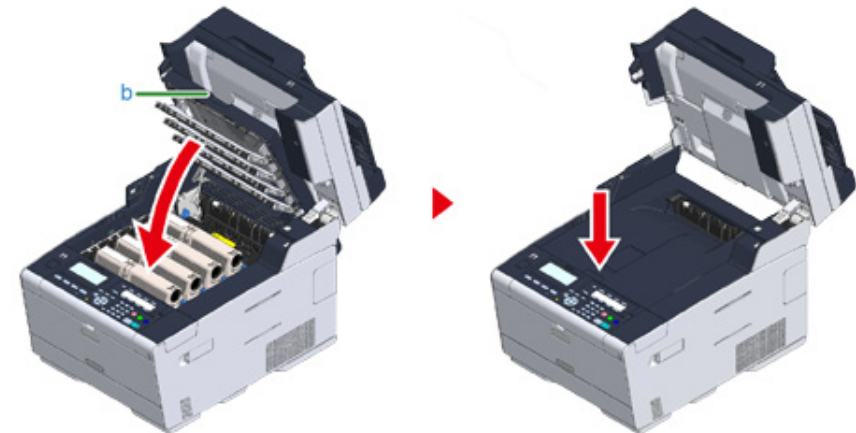

- 18** Hold the handle (B) to close the scanner unit (c).



Do not close the scanner unit vigorously. It may cause the document feed roller of ADF to fall and get in the way of loading documents.

If the document feed roller of ADF has fallen, open and close the ADF cover.

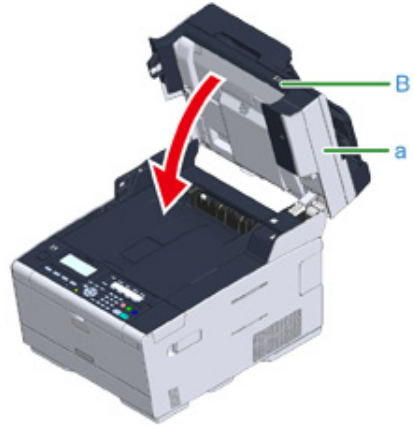

If a Document Jam Occurs

This section describes how to handle when a document jam occurs.

- [If a Document is Visible in the Paper Path](#)
- [If a Document is Invisible in the Paper Path](#)

If a Document is Visible in the Paper Path

- 1 Open the ADF cover (a).



- 2 Pull out the document upward.



Sticky notes and labels attached on the documents may cause a document jam.

When using the ADF, remove sticky notes or labels from the document. If removing labels is unavailable, use the document glass.

- 3 Close the ADF cover (a).

Remove the document on the document tray, and then close the ADF cover. Otherwise, documents may be torn or folded.

If a Document is Invisible in the Paper Path

- 1 Open the ADF cover (a).



- 2 Remove the jammed document. Proceed to step 4 if you cannot remove the jammed document.



Do not try to remove the document by force.



- 3 If you were able to remove the document, proceed to step 8.

- 4 Open the inner cover (b).



- 5 If you can see the edge of the jammed document, pull it out gently.



- 6 If the edge of document jammed under the document tray (c) can be seen, lift up the document tray and gently pull out the document to remove.



- 7 If you were able to remove the document, close the inner cover.



- 8 Close the ADF cover slowly.
Remove the document on the document tray, and then close the ADF cover.
Otherwise, documents may be torn or folded.



If an error occurs while copying, the copying gets canceled.

Copy Problems

This section describes problems with the copy function.







If you cannot solve a problem with the following solutions, contact your dealer.

- [Unable to Copy](#)
- The Copied Output is Different from the Original (Advanced Manual)
- Other Problems (Copy) (Advanced Manual)



Unable to Copy

• Unable to copy



Point to check	Solution	Reference
Is the machine turned on?	Turn the machine on.	Turning the Machine On
Is the machine being initialized?	Wait until initialization is complete.	-
Is your document set properly?	Set the document properly.	Setting a Document
Is there paper in the tray?	Load paper in the tray. Check that the paper cassette is installed in the machine.	Loading Paper
Is the proper size paper for the document loaded in the tray?	Load the proper size paper for the document.	Loading Paper
Is the paper tray selectable if [Paper Feed] is set to [Auto]?	Press the  (SETTING) button on the operator panel, select [Paper Setup] > [Select Tray] > [Copy] > the paper tray on which the paper you use is loaded, and then select [ON] or [ON(Prior)].	Specifying the Paper Feed Tray (Paper Feed) (Advanced Manual)
Is the loaded paper compatible with duplex printing?	Duplex copying cannot be performed depending on the paper size, paper type, or paper weight. Load the appropriate paper for duplex printing, and then set the paper size, document type, and document weight correctly.	Loading Paper
Is the media type of the paper tray set to [Plain] or [Recycled]?	If [Paper feed] is set to [Auto], set the media type for the paper tray to [Plain] or [Recycled].	Loading Paper
Is there a paper jam?	Check an error message, and then remove any jammed paper.	If Paper Jams Occur
Is there an empty toner cartridge?	Replace the empty toner cartridge with a new toner cartridge.	Replacing the Toner Cartridges
Does the image drum reach its lifetime?	Replace the image drum with a new image drum.	Replacing the Image Drum
Does the fuser unit reach its lifetime?	Replace the fuser unit with a new one.	Replacing the Fuser Unit (Advanced Manual)
Does the belt unit reach its lifetime?	Replace the belt unit with a new one.	Replacing the Belt Unit (Advanced Manual)
Are any covers on the machine opened?	Close all the covers.	-
Has any error occurred?	Clear the error.	Error Message List

Point to check	Solution	Reference
Is another job in progress?	Start copying after the other job is complete.	-
Is a print job from a computer or other device in progress?	Wait until printing is complete.	-
Is a fax being sent in real time?	Wait until the transmission is complete.	-
Is Continuous Scan mode on?	Select [Scan completed] on the display screen.	 Enabling Continuous Scan Mode (Continuous Scan) (Advanced Manual)
Is the machine offline?	Press the  (PRINT) button, and then select [Online].	-
Are you authorized to make copies?	Enter the authorized PIN or user name and password.	 Enabling Access Control (Advanced Manual)



• Unable to change copy ratios

Point to check	Solution	Reference
Is [Cannot found appropriate paper size. Please confirm paper of tray.] displayed?	Specify a paper feed tray. Or specify a zoom ratio manually.	 Making Enlarged or Reduced Copies (Zoom) (Advanced Manual)
Did you press Reduce or Enlarge?	The specified size of paper is not loaded in the trays. Specify a paper feed tray. Or specify a zoom ratio manually.	 Making Enlarged or Reduced Copies (Zoom) (Advanced Manual)

• Unable to copy mixed size documents

Point to check	Solution	Reference
Is [Mixed Size] set to [OFF]?	Set [Mixed Size] to [ON].	 Copying Different Size Documents (Mixed Size) (Advanced Manual)
Is the size of your document supported for making mixed size copies?	Use documents sizes supported for mixed size copying.	 Copying Different Size Documents (Mixed Size) (Advanced Manual)
Is paper of the required sizes loaded?	Load paper of the required sizes on each paper tray. The paper trays need to be set to [ON] or [ON(Prior)] from the  (SETTING) button > [Paper Setup] > [Select Tray] > [Copy] on the operator panel.	-

• Unable to sort copies

Point to check	Solution	Reference
Is [Sort] set to [OFF]?	Set [Sort] to [ON].	 Sorting Each Set in Page Order (Sort) (Advanced Manual)
Is memory full?	Reduce the number of document pages. Check the free space in memory. Delete unnecessary jobs in memory.	 Checking the Free Space in Memory/Hard Disk Drive (Advanced Manual)

Scan Problems

This section describes problems with the scan function.



If you cannot solve a problem with the following solutions, contact your dealer.

-
- [Unable to Scan](#)
 - [Scan To E-Mail Problems \(Advanced Manual\)](#)
 - [E-mail/Internet fax/FaxServer Error Code \(Advanced Manual\)](#)
 - [Scan To Computer Problems \(Advanced Manual\)](#)
 - [Unable to Save Files in a Network Folder \(Advanced Manual\)](#)
 - [Network Connection Problems \(Scan\) \(Advanced Manual\)](#)
 - [Wireless LAN Connection Problems \(If Wireless LAN Module is Fitted\) \(Scan\) \(Advanced Manual\)](#)
-

Unable to Scan

Point to check	Solution	Reference
Is the machine turned off?	Turn the machine on.	Turning the Machine On
Is the cable connected to the machine?	Check the cable connections, and then connect the cables properly.	Connecting a LAN Cable/USB Cable
Is there any damage to the cable?	Change the cable.	-
Is the network setting correct?	Set the network setting correctly.	Connecting a LAN Cable/USB Cable
Has any error occurred?	Follow the on-screen instructions on the display screen of the machine. If you use the Scan To PC function, refer to "Scan To Computer Problems (Advanced Manual)".	Error Message List Scan To Computer Problems (Advanced Manual)

Print Problems

This section describes problems with printing from a computer.





- If you cannot solve a problem with the following solutions, contact your dealer.
- For problems caused by an application, contact the manufacturer of the application.

- [Unable to Print](#)
- [Network Connection Problems \(Print\) \(Advanced Manual\)](#)
- [Wireless LAN Connection Problems \(If Wireless LAN Module is Fitted\) \(Print\) \(Advanced Manual\)](#)
- [USB Connection Problems \(Advanced Manual\)](#)

Unable to Print

• Common to Windows and Mac OS X

Cause	Solution	Reference
The machine is in Sleep mode or Deep Sleep mode.	Press the  (POWER SAVE) button to enter standby status.	Saving Power Consumption with the Power Save Function
The machine is turned off.	Turn the machine on.	Turning the Machine On
A LAN cable or USB cable is unplugged.	Check that the cable is plugged into the machine and computer properly.	Connecting a LAN Cable/USB Cable
There may be a problem with a cable.	Replace the cable with a new cable.	-
The machine is offline.	Press the  (PRINT) button, and then select [Online].	-
An error message is displayed on the operator panel.	Check the error messages displayed on the operator panel or press [?] on the operator panel.	Error Message List
The interface setting is disabled.	Whether there is a consistency with the machine's settings and the network connection environment, check the settings of the interface that you are using on the operator panel.	Connecting a LAN Cable/USB Cable Connecting to a Wireless LAN (Only When the Wireless LAN Module is Mounted)
There is a problem with the print function.	Check if the menu map can be printed.	Checking the Information of the Machine (Advanced Manual)
The power switch LED lamp quickly flashes at approximately 0.3-second intervals.	A malfunction may occur in the machine. Unplug the power cord immediately, and then contact your dealer.	-



• For Windows

Cause	Solution	Reference
The machine is not set as the default printer.	Set the machine as the default printer. Right-click the [OKI MC563] icon on the [Devices and Printers] folder, and then select [Set as Default Printer]. * Indicates the driver type. (ex. PCL6/PS/XPS/FAX)	-

Cause	Solution	Reference
The output port of the printer driver is incorrect.	Select the output port for connecting the LAN cable or USB cable.	-
The machine is processing data from another interface.	Wait until printing is complete.	-
[Receiving data timeout] is displayed on the operator panel and the machine does not print.	Press the  (SETTING) button on the operator panel, select [Admin Setup] > [Print Setup] > [Print menu] > [Printer Adjust] > [Timeout Injob], and then select a longer time. The factory default setting is 40 seconds. If the job is not printed with "Received invalid data" displayed, the selected emulation language may not match this machine (model). Make sure that the printer driver you use supports this model of the machine.	-

Fax Problems

This section describes problems with the fax function.





If you cannot solve a problem with the following solutions, contact your dealer.

- [Unable to Send a Fax](#)
- [Unable to Receive a Fax](#)
- [Unable to Send or Received a Fax \(Advanced Manual\)](#)
- [Other Problems \(Fax\) \(Advanced Manual\)](#)
- [Fax Error Codes \(Advanced Manual\)](#)

Unable to Send a Fax



• Unable to send a fax

Point to check	Solution	Reference
Did you send in the correct procedure?	Check the procedure, and then try again.	Entering Fax Number to Send a Fax
Did you specify the correct fax number?	If you are using speed dial, print the speed dial list to check the registration.	Entering Fax Number to Send a Fax Specifying a Destination from Phone Book (Advanced Manual) Specifying a Destination Using One-touch Button (Advanced Manual) Specifying a Destination from Transmission History and Reception History (Advanced Manual)
Did you specify the appropriate dial type?	Specify the appropriate dial type for your region.	User Install (Advanced Manual)
Has any problem occurred at the recipient machine?	Ask the recipient to have the recipient's machine ready for reception.	-
Is the error code [23] marked on the Transmit/Receipt Journal?	Press the  (SETTING) button on the operator panel, select [Admin Setup] > [User Install], and then set [MF(Tone)/DP(Pulse)] depending on your environment.	Checking the Information of the Machine (Advanced Manual) User Install (Advanced Manual)
Is the error code [26] marked on the Transmit/Receipt Journal?	Press the  (SETTING) button on the operator panel, select [Admin Setup] > [Fax Setup] > [Fax Setting], and then change the setting for [PBX Line].	Checking the Information of the Machine (Advanced Manual) Administrator Setup (Advanced Manual)



• A document cannot be sent continuously

Point to check	Solution	Reference
Did you set the document correctly in the ADF?	Set the document after aligning the leading edge.	Setting a Document





- After dialing, even if the  (MONO) button is pressed, the machine cannot send a fax

Point to check	Solution	Reference
Did you specify the appropriate dial type?	Specify the appropriate dial type for your region.	 User Install (Advanced Manual)
Is the document set properly?	Set the document properly.	 Setting a Document
Did you dial the correct number?	Dial the correct number.	-
Is the recipient's line busy?	Wait until the line is opened, and then try again.	-

- Unable to send a fax manually









Point to check	Solution	Reference
Did you put the handset down before pressing the  (MONO) button?	Press the  (MONO) button first.	 Sending a Fax after Calling (Manual Transmission) (Advanced Manual)

- A document cannot be scanned during memory transmission



Point to check	Solution	Reference
Is the document set properly?	Set the document properly.	 Setting a Document
Is memory full?	Check the reserved transmission. Print the documents received with the confidential transmission. Delete the documents stored in the bulletin board box. Delete the documents stored in the Secure Receive.	 Sending at a Specified Date and Time (Delayed Tx) (Advanced Manual)  Printing a Document That is Received in the Confidential Box of This Machine (Advanced Manual)  Receiving a Document That is Saved in a Destination Bulletin Board Box by Fax (Fcode Polling) (Advanced Manual)  Setting Secure Reception (Advanced Manual)

Unable to Receive a Fax

- Unable to receive a fax

Point to check	Solution	Reference
Did you specify the appropriate reception mode?	Check the reception mode.	 Setting the Reception Mode
Is there paper in the tray?	Load the paper.	 Loading Paper
Is there a paper jam?	Check an error message, and then remove any jammed paper.	 If Paper Jams Occur
Is a telephone cable connected to the machine and telephone line correctly?	Connect the telephone cable correctly.	 Connecting a Telephone Line
Is memory full?	Check the reserved transmission. Check whether paper jams or paper runs out.	 Cancelling a Fax Transmission  If Paper Jams Occur
	Print the documents received with the confidential transmission. Delete the documents stored in the bulletin board box. Delete the documents stored in the Secure Receive.	 Printing a Document That is Received in the Confidential Box of This Machine (Advanced Manual)  Setting Secure Reception (Advanced Manual)

- Unable to receive a fax manually

Point to check	Solution	Reference
Did you put the handset down before pressing the  (MONO) button?	Press the  (MONO) button first.	 Setting the Reception Mode

- Fcode polling reception is not available

Point to check	Solution	Reference
Did the sender store a polling document in a bulletin box?	Ask the sender to store the polling document.	-

If an Error Message is Displayed on the Operator Panel

If an error occurs in this machine, an error message and/or an error code (a 3-digit number) is displayed on the operator panel and  (STATUS) on the operator panel blinks or lights up.



- [Error Message List](#)

Error Message List

Wait a moment. Network initializing ...

The network is being initialized.
Wait for a while until the machine connects to the network.

Checking File System

File system in a flash memory device is being checked. Wait for a while.

Inspection is required. PU Flash Error

Turn the machine off, and then back on. If the same error occurs, contact your dealer.

Inspection is required. PU Communication Error

Turn the machine off, and then back on. If the same error occurs, contact your dealer.

Offline Mode

Press [Print] > [Online] on the operator panel. The  (STATUS) button turns off when the machine turns online.

Data present.

Data remains unprinted. Wait for a while and if the message does not disappear, check the data.

Deleting data.

The job was cancelled or user is unauthorized. Wait for a while.

Warming up.

The machine is adjusting the temperature of the fuser unit. Wait for a while.

Preparing ...

Color registration and density are being adjusted. Wait for a while.

Wait a moment. Executing maintenance.

The programs on the machine are being updated.
Do not turn the machine off until the update completes.
The machine automatically restarts after the update completes.

Toner Low.

The toner indicated on the screen is low. Have a new toner cartridge ready.

Waste Toner Full Replace with new Toner Cartridge.

Waste toner is full. Replace the toner cartridge with a new one.
C: Cyan (blue), M: Magenta (red)

C Non Recommended Toner.

An optimum C (Cyan, blue) toner cartridge is not installed.
Use a toner cartridge that matches your machine.

M Non Recommended Toner.

An optimum M (Magenta, red) toner cartridge is not installed.
Use a toner cartridge that matches your machine.

Y Non Recommended Toner.

An optimum Y (Yellow) toner cartridge is not installed.
Use a toner cartridge that matches your machine.

K Non Recommended Toner.

An optimum K (Black) toner cartridge is not installed.
Use a toner cartridge that matches your machine.

Error Postscript

A postscript error has occurred. Please check data.

Image Drum Unit Near Life

The image drum indicated on the screen is near life. Have a new image drum ready.
C: Cyan (blue), M: Magenta (red), Y: Yellow, K: Black

Fuser Unit Near Life

The fuser unit is near life. Have a new fuser unit ready.

Belt Unit Near Life.

The belt unit is near life. Have a new belt unit ready.

Please change Fuser Unit.

The fuser unit reaches its lifetime.
Replace the fuser unit with a new one.

Please change Belt Unit.

The belt unit reaches its lifetime.
Replace the belt unit with a new one.

Toner Empty

The toner indicated on the screen is empty. Replace the empty toner cartridge with a new one.
C: Cyan (blue), M: Magenta (red), Y: Yellow, K: Black

Toner cartridge not installed.

A color toner cartridge indicated on the screen is not installed.
Install the toner cartridge.
C: Cyan (blue), M: Magenta (red), Y: Yellow, K: Black

Please install new Image Drum Unit. Image Drum Life.

The image drum indicated on the screen reaches its lifetime.
Replace the image drum with a new one.
C: Cyan (blue), M: Magenta (red), Y: Yellow, K: Black

[TRAY] Empty.

No paper is loaded in the indicated tray. Load paper.

File System is full.

Memory in the file system is full.
Delete unnecessary files.

File System is write protected.

The File System is write-protected.
Contact the administrator of the MFP.

Memory Overflow

Insufficient memory error has occurred during collate printing.
Reduce the number of pages to print.

Memory Overflow

Memory full error has occurred while receiving PC Fax data. Press [Close].

Access Limitation Error

Unauthorized job was sent or unauthorized user attempted to print or send a fax. Data was deleted. Contact your administrator to use this machine.

File erasing ...

Stored document files are being deleted.
Wait for a while.

Erased Data Full

Files supposed to be deleted are full. Erase the files.

Expired saved files have been deleted.

Private printing files whose storage period expired were automatically deleted.

Disk Read/Write Error

An error has occurred in the file system. Press [Close].

Flash Error

An error has occurred when firmware was being updated.
Contact the administrator.

Invalid print data received.

Invalid print data or PC fax transmission data was received. To erase the message, press [Close].
If you performed private printing, the data was deleted because it was incomplete. Print again.

Received data has been discarded because Job Type is restricted.

Data whose job type is not defined in the acceptable job type settings was received. The data was discarded without being processed.

Select a job type defined in the acceptable job type settings for [Job Type] of the printer driver and print again.

 [About Screens and Functions of Each Printer Driver](#)

Paper request on MP Tray.

Selecting the message displays "Please install paper on MP Tray. Please set paper A4 (or another paper size).To cancel, select [Cancel]". To print, load the specified size of paper on the MP tray and select [Start].To cancel the print job, select [Cancel] on the operator panel.

Tray Media Mismatch: 461, 462, 463, 464 Please install paper [MEDIA_SIZE] [MEDIA_TYPE] on [TRAY].

The size and type of paper set in the machine do not match those indicated on the screen. Use the same size and type of paper selected on the application.

Tray Media Mismatch: 460 Please install paper [MEDIA_SIZE] [MEDIA_TYPE] on [TRAY].

The size and type of paper loaded in the MP tray do not match those indicated on the screen. Make sure that the size and type of paper loaded in the MP tray match those selected on the application.

Wait a moment. Network Configuration writing ...

Network settings for this machine is changed. The new settings are being stored. Wait for a while.

Wait a moment. Network initializing ...

Network settings for this machine are initializing. Wait for a while.

Please install paper on [TRAY] . : 490, 491, 492, 493, 494 Please set paper [MEDIA_SIZE]

No paper is loaded in the indicated tray. Load paper of the displayed size.

Please close [TRAY].: 440, 441, 430, 431, 432, 433

The tray is not installed. Install the cassette. If the cassette is already inserted, pull it out, and then insert it again.

Memory Overflow: 420

Data is too complicated. Memory full error has occurred during processing. Reduce the volume of the print data.

Please install new K Toner Cartridge. 414, 415, 416, 417

Waste toner of the toner cartridge is full. Opening and closing the front cover can resume printing for a while, but it may damage the image drum. Replace the toner cartridge with a new one as soon as possible.

C: Cyan (blue), M: Magenta (red), Y: Yellow, K: Black

[COLOR] Toner Empty: 410, 411, 412, 413

The indicated cartridge ran out of toner.

Opening and closing the front cover can resume printing for a while, but it may damage the image drum. Replace the toner cartridge with a new one as soon as possible.

C: Cyan (blue), M: Magenta (red), Y: Yellow, K: Black

C Non Recommended Toner. Error: 552, 556, 616, 622

The installed C (Cyan, blue) toner cartridge is not optimum.
We recommend using an optimum toner cartridge.

M Non Recommended Toner. Error: 551, 555, 615, 621

The installed M (Magenta, red) toner cartridge is not optimum.
We recommend using an optimum toner cartridge.

Y Non Recommended Toner. Error: 550, 554, 614, 620

The installed Y (Yellow) toner cartridge is not optimum.
We recommend using an optimum toner cartridge.

K Non Recommended Toner. Error: 553, 557, 617, 623

The installed K (Black) toner cartridge is not optimum.
We recommend using an optimum toner cartridge.

[COLOR] Toner Cartridge not installed: 610, 611, 612, 613

A color toner cartridge indicated on the screen is not installed.
Install the toner cartridge.

C: Cyan (blue), M: Magenta (red), Y: Yellow, K: Black

Please check [COLOR] Toner Cartridge.: 540, 541, 542, 543

The image drum sensor error has occurred in the image drum indicated on the screen.
Uninstall the image drum, and then install it again.

If the message persists, uninstall the toner cartridge and install it again.

If the toner cartridge is not installed, install it.

C: Cyan (blue), M: Magenta (red), Y: Yellow, K: Black

Paper Size Error. Please open the scanner unit and the Output Tray and check paper size. Error: 400

Paper size error has occurred in the indicated tray. Make sure that the size of paper loaded in the tray matches the [Paper Size] setting set on the operator panel. Load paper according to the paper size and direction set. To resume printing, open and close the output tray.

If the setting set on the operator panel is wrong, cancel printing first, set the right paper size from [Paper Size] on the operator panel, and then print again.

Make sure that the cassette does not feed multiple sheets of paper at a time after starting printing. If it happens, remove paper, and then load paper correctly.

Paper Jam: 390 Please open the scanner unit and the Output Tray.

Paper jammed via the paper feed path from the MP tray. Remove jammed paper.
If the edge of the jammed paper is not visible, open the front cover and remove the paper.

Paper Jam: 391, 392, 393 Please open the scanner unit and the Output Tray.

A paper jammed via the paper feed path from the indicated tray.
Pull out the cassette, and then remove paper. If multiple sheets of paper are fed at a time, remove paper and reload paper.
Make sure that the paper stoppers are set in the right position.

Paper Jam: 380, 381, 382, 385, 389 Please open the scanner unit and the Output Tray.

A paper jam has occurred inside the machine.
Open the output tray and remove jammed paper.

Paper Jam: 370, 371, 372 Please open the scanner unit and the Output Tray.

A paper jam has occurred inside the machine.
Open the output tray and remove jammed paper.

Please install new Image Drum Unit. Error: 350, 351, 352, 353

The image drum indicated on the screen reaches its lifetime.
Replace the image drum with a new one.
Opening and closing the output tray can resume printing for a while. Replace with a new one as soon as possible, however.
C: Cyan (blue), M: Magenta (red), Y: Yellow, K: Black

Please install new Image Drum Unit. Error: 560, 561, 562, 563, 564, 565, 566, 567

The image drum indicated on the screen reaches its lifetime.
Replace the image drum with a new one.
C: Cyan (blue), M: Magenta (red), Y: Yellow, K: Black

Install New Image Drum. Printing disabled due to low threshold of Image Drum life. Error: 680, 681, 682, 683

Printing has stopped because the image drum indicated on the screen reached its lifetime. Replace with a new image drum to print.
C: Cyan (blue), M: Magenta (red), Y: Yellow, K: Black

Please change Fuser Unit.: 354

The fuser unit reaches its lifetime.
Replace the fuser unit with a new one.
Opening and closing the output tray can resume printing for a while. Replace with a new one as soon as possible for maintaining the print quality.

Please change Belt Unit.:Error: 355

The belt unit reaches its lifetime.
Replace the belt unit with a new one.
Opening and closing the output tray can resume printing for a while. Replace with a new one as soon as possible for maintaining the print quality.

Please change Belt Unit.: 356

Waste toner of the belt unit is full. Replace the belt unit with a new one. Opening and closing the output tray can resume printing for a while. Replace with a new one as soon as possible for maintaining the print quality.

Please check [COLOR] Toner Cartridge.: 544, 545, 546, 547

A color toner cartridge indicated on the screen is not installed.
Make sure that the lever on the toner cartridge is fully turned and the protective tape is removed.
C: Cyan (blue), M: Magenta (red), Y: Yellow, K: Black

Please check Image Drum Unit. Error: 340, 341, 342, 343

The indicated image drum is not installed correctly.
Remove and re-install the image drum.
C: Cyan (blue), M: Magenta (red), Y: Yellow, K: Black

Please check Fuser Unit.: 320

The fuser unit is not properly installed. Remove and re-install the fuser unit.

Please check Belt Unit.: 330

The belt unit is not properly installed. Remove and re-install the belt unit.

Please check the Output Tray.: 310

Indicated cover is open. Close the cover.
Error: 310 The output tray.

Power OFF/ON

Turn the machine off, and then back on.
If the same error occurs, contact your dealer.

Inspection is required.

Turn the machine off, and then back on.
If the same error occurs, contact your dealer.

Cancelling ...

The cancel button was pressed while copying. The copy job is being cancelled. Wait for a while.

ADF Cover Open

The ADF cover of the scanner is open. Close the cover.

Document Jam Please open the scanner unit and the ADF cover.

Paper jammed in the ADF of the scanner.
Open the ADF cover and remove jammed paper.

Lamp Error. Please call service.

Light volume of the scanner is low. Contact your dealer.

USB Memory Full

Scan To USB Memory was cancelled because the USB Memory is full.
Check the free space in the USB Memory.

Writing Failed

The USB Memory is write-protected. Unlock the protection.

USB Memory disconnected.

The USB Memory was removed while performing Scan To USB Memory. Connect USB Memory and try again.

Connect to PC failed.

No destination computer was found for Scan to Computer. Make sure that your computer is turned on and recordable.
To erase the message, press [Close].

 [Scan To Computer Problems \(Advanced Manual\)](#)

Communication Error

An error has occurred during fax transmission or fax reception.

Telephone

The external phone is in use. Use the device after ending the call in progress.

File Transmission Error

An error such as a malfunction of the server or disconnection of a LAN cable has occurred while performing Scan To shared folder.
Check the network connection.
To erase the message, press [Close].

Please check SMTP settings.

Cannot connect to the SMTP server. Check the network settings.

Please check POP3 settings.

Cannot connect to the POP3 server. Check the network settings.

SMTP Login failed.

An attempt to log into the SMTP server ended up an authentication error.
Check the network settings.

SMTP Auth. Unsupported

The SMTP server does not support the authentication system.
Check the network settings.

POP3 Login failed.

An attempt to log into the POP3 server ended up an authentication error.
Check the network settings.

Getting target IP failed. Please Check DHCP settings.

The DHCP server cannot be detected. Check the network connection.

Please check DNS settings.

Cannot connect to the DNS server. Check the network connection.

Please check Server settings.

Cannot connect to the file server. Check the network settings.

Server Login failed.

Logging into the file server failed. Check the server settings.

Entering directory failed.

Connecting to the directory of the FTP server failed. Check the server settings.

Changing data Transfer Type failed.

File transmission failed because the file transfer type was not accepted by the FTP server. Change the FTP transfer type to "binary".

Not authorized to write file.

Files sent using Scan To shared folder could not be written. Check the access rights for the shared folder.

Storage Space Full

Memory in the FTP server is low. Delete unnecessary files and ensure the free space.

Please change File Name.

The specified file name is not acceptable. Check the FTP server settings and change the file name.

Device communication protocol not supported.

The server does not support CIFS or FTP. Check the server settings.

Please check Network Share Name.

The name of the network shared folder is not correct. Check the folder name.

Please insert USB Memory.

Scan To USB Memory or print from USB Memory with USB Memory not inserted was attempted.
Insert USB Memory.

[TRAY] missing.

The cassette in the indicated tray is pulled out.
Install the cassette.

Access Limitation Error Monochrome printing was performed due to the color printing limitation.

A color print job was converted to a mono print job due to an unauthorized user. Contact your administrator for color printing.

Access Limitation Error Data was deleted due to the color printing limitation.

A color print job was deleted due to an unauthorized user. Contact your administrator for color printing.

Access Limitation Error Deleted unauthorized user data.

Access Limitation Error Data was deleted due to the printing limitation.

Please remove the connected USB device. Unsupported USB device is connected.

An unsupported USB device is connected. Remove the USB device.

Please remove the connected USB device. USB device has not been recognized.

The connected USB device was not recognized. Remove the USB device.

Please remove the USB Hub. USB Hub is connected.

A USB hub is connected. Remove the USB hub. This machine does not support USB hub.

Inspection is required. SIP Error

Turn the machine off, and then back on. If the same error occurs, contact your dealer.

Job Log Database Error

A data base access error has occurred while writing or reading the job log. Turning the machine off and on may resolve the problem.

To erase the message, press [Close].

Job Log Buffer Full (Delete old logs)

Old job logs were deleted, because job log buffer was full.

Decode error occurred. Please check image data.

An error has occurred in the image data sent to this machine. Check the image data.

Access denied to PC. Please check PC.

Connecting to a computer failed when performing Scan to Computer. Check the settings on the computer.

 [Scan To Computer Problems \(Advanced Manual\)](#)

Deleting data.

This machine ran out of color toner. Color print data is being deleted.
Wait for a while.

Color toner empty. Job cancelled

The print data was cancelled because color toner is empty. To delete the message, press the  (OK) button.

Error PDF

The PDF file is damaged.
Check the file.

Invalid Password

This PDF file is password protected.

This document restricts printing to a valid owner password.

Password protected PDF files cannot be printed. Unprotect the PDF before printing.

It was not possible to communicate with the SNTP server.

Obtaining current time from the SNTP server failed. Check the server.

USB Memory disconnected.

The USB Memory was removed while printing from USB Memory. Do not remove USB Memory while printing is in progress.

Cannot open the file.

The specified file could not be Opened. Check the file.

Cannot read the file.

Files could not be read. Check the device where the files are stored.

Please close Rear Output Tray. 581:Cannot print with duplex.

2-sided printing failed because the rear output tray is open.
Close the rear output tray and tray again.

Please open the Output Tray. 409:Rear Output Tray Error

The rear output tray was moved while duplex printing.
Close the rear output tray and remove the jammed paper remaining inside of the unit.

Toner Empty

The indicated cartridge ran out of toner.
Replace the empty toner cartridge with a new one.

Wait Timeout is disabled. If your printer is connected to USB port, it may become unable to print a job without via the USB port.

Wait Timeout is disabled.
Press ▼ button, select [Setting] > [Admin Setup] > [Print Setup] > [Print menu] > [Printer Adjust] > [Timeout Injob] on the operator panel, and then select a longer print timeout value.

Memory Overflow has occurred during Fax Tx reservation.

Insufficient memory error has occurred during Scan To fax.

Memory Overflow

Insufficient memory error has occurred during fax reception.

E-mail receiving has been cancelled.

Receiving E-mail was cancelled because the format of the E-mail is not supported or attached file is too large.
Check the file format and size of the attached file.

Wireless settings are incomplete.

Wrong values are set or items remain unset in the wireless LAN settings. Check the wireless settings.

Not connected to wireless access point.

No wireless LAN access points are found.
Make sure that the access point is turned on.
Disconnect and re-connect to wireless LAN.

Wireless startup failed.

Turn the machine off, check that the wireless LAN module is correctly installed, and then reboot the machine. If the error persists, contact your dealer.



Firmware Update Error Please try again. If network doesn't work, please try firmware update over USB.

Updating the firmware failed. Update again.

Caution, unknown Consumable detected Go to User Manual "Trouble Shooting" to restore operation Error: 709

You can use any consumables in your product, but you must accept the risks of using non-genuine consumables. If the use of non-genuine consumables causes damage to the product or results in your product not functioning to its full specification, then such damage or effect on the product is not covered by warranty.

To accept these risks and to restore function;

- (1) Turn off your product.**
- (2) Press and hold the  (CLEAR) button and turn your product on.**
- (3) After start up, release the  (CLEAR) button.**

Note: This operation will be recorded for future reference.

[PAGES] Pages Left.

The image drum indicated on the screen reaches its lifetime.
Replace the image drum with a new one.
C: Cyan (blue), M: Magenta (red), Y: Yellow, K: Black

Image Drum Life. Print Quality Not Guaranteed.

The image drum indicated on the screen reaches its lifetime.
Replace the image drum with a new one.
C: Cyan (blue), M: Magenta (red), Y: Yellow, K: Black

Receiving data timeout.

Data could not received within a certain period of time.
Set a longer data reception timeout value.

IPv4 address is conflicted. Please change IPv4 address.

The IP address assigned to this machine is duplicated with that of another device.
Check the IP addresses, and then assign another IP address.

Duplex print error.

Duplex printing is not available on the specified paper.
Check the size and thickness of paper.
Press [Close].

Changing Language. Panel operation is disabled.

Display language is being changed.
Wait for a while.

Language Change Failed. Error num: [CODE]

Switching display languages failed. Press the power button to turn the machine off, and then back on.

Detected an abnormality of internal database. The data must be deleted. After pressing [Format], the data will be deleted, and then reboot.

Data base is beyond restoration.
To delete the data base, press [Format].

10

Operating Management/ Specifications

Changing the Administrator Password



Saving Power Consumption with the Power Save Function

Specifications

This section describes how to manage the machine and its specifications.





Changing the Administrator Password

It is recommended to change the administrator password to protect your security. Set the administrator password using from 6 to 12 alphanumeric characters. Be careful not to forget the set password.

- 1 Press the  (SETTING) button on the operator panel.
- 2 Press the  button to select [Admin Setup] and press the  (OK) button.
- 3 Enter the administrator password.



The factory default administrator name and password are "admin" and "999999" respectively.

- 4 Select [Enter], and then press the  (OK) button.
- 5 Press  or  several times and press [Manage Unit].
- 6 Press  or  several times and press [Admin Password].
- 7 Enter a new password, and then press [OK].
- 8 Enter the password again.
- 9 Press [OK].

Saving Power Consumption with the Power Save Function

The machine has three Power Save modes: Power Save, Sleep, and Deep Sleep.

In Power Save mode, the display screen turns off and the power saving indicator lights up or blinks.

Press the  (POWER SAVE) button to enter Power Save mode.

After being left unoperated for a certain period of time (a minute by factory default), the machine automatically enters Power Save mode.

After being left unoperated for a certain period of time (15 minutes by factory default) in Power Save mode, the machine enters Sleep mode, Deep Sleep mode.





- For details on how to change the idle time before entering Power Save mode, see "[Setting the Length of Idle Time Before Entering Power Save Mode](#)".
- For details on how to change the idle time before entering Sleep mode, see "[Setting the Length of Idle Time Before Entering Sleep Mode](#)".

Press the  (POWER SAVE) button to recover from Power Save mode. The machine also recovers from Power Save mode, when some data is received from a computer or another device, or a document is set.



- [Setting the Length of Idle Time Before Entering Power Save Mode](#)
- [Setting the Length of Idle Time Before Entering Sleep Mode](#)
- [Restrictions in Power Saving Function](#)
- [Automatically Turning the Machine Off \(Auto Power Off\)](#)
- [Setting the Length of Idle Time Before Auto Power Off Works](#)

Setting the Length of Idle Time Before Entering Power Save Mode



- 1 Press the  (SETTING) button on the operator panel.
- 2 Press the  button to select [Admin Setup] and press the  (OK) button.
- 3 Enter the administrator password.



The factory default administrator name and password are "admin" and "999999" respectively.



- 4 Select [Enter], and then press the  (OK) button.
- 5 Press  or  several times and press [Manage Unit].
- 6 Press [Power Save].
- 7 Press [Power Save Time].
- 8 Select transition time.

Setting the Length of Idle Time Before Entering Sleep Mode

- 1 Press the  (SETTING) button on the operator panel.
- 2 Press the  button to select [Admin Setup] and press the  (OK) button.
- 3 Enter the administrator password.



The factory default administrator name and password are "admin" and "999999" respectively.

- 4 Select [Enter], and then press the  (OK) button.
- 5 Press  or  several times and press [Manage Unit].
- 6 Press [Power Save].
- 7 Press [Sleep Time].
- 8 Select transition time.

Restrictions in Power Saving Function

The machine does not enter Sleep mode in the following cases.

- When an error occurs on the machine
- When a delayed fax transmission is set
- When a fax transmission is waiting for redialing

The machine does not enter Deep Sleep mode in the following cases.

- IPsec is enabled
- A TCP connection is established

Example: A connection is established with Telnet or FTP.

When the transition time to enter Sleep mode or Deep Sleep mode from Power Save mode elapses and the connection is disconnected, the machine enters Sleep mode.

- E-mail reception is enabled
- Wireless LAN is enabled
- Google Cloud Print is enabled
- LLTD is enabled
- IPv6 Global Address is assigned

In Deep Sleep mode, you cannot use the following protocols to print.

- NBT

In Deep Sleep mode, you cannot search or set by using the following functions and protocols.

- NBT

In Deep Sleep mode, the following protocols that have the client function do not operate.

- E-mail alert*2
- SNMP Trap
- WINS*1
- SNTP*2

*1 The elapse time in Deep Sleep mode is not included in the intervals of WINS update time.

WINS regular updates are not performed in Deep Sleep mode, possibly resulting in names that are registered in the WINS server being deleted.

- *2 The elapse time in Deep Sleep mode is not included in the intervals of the e-mail alert notification time and the intervals of the NTP server update time.

In a network environment where a large number of packets are sent, the machine automatically exits Deep Sleep mode to Sleep mode and responds.

Also, if a terminal that runs searches with Bonjour, such as Mac or iPhone, is connected to the same network, the machine automatically exits Deep Sleep mode to Sleep mode and responds.

This machine automatically enters Deep Sleep mode after a certain period of time.

Automatically Turning the Machine Off (Auto Power Off)

The machine equipped with the Auto Power Off function which automatically turns the power off if the machine is left unoperated for a certain period of time.

There are three options for the Auto Power Off setting and [Auto Config] is set by factory default.



- [Auto Config]: The machine automatically turns off after being left unoperated for a certain period of time unless the machine is in the following conditions.
 - A LAN cable is connected to the network interface connector.
 - A telephone cable is connected to the LINE connector.
 - Wireless LAN is enabled.
- [Enable]: If you do not use the machine for a certain period of time, the machine automatically turns off.
- [Disable]: Disables the Auto Power Off function. The machine does not automatically turn off.



The machine does not automatically turn off in the following cases.



- When an error has occurred
- When a delayed transmission is reserved
- When a fax transmission is waiting for a redial

Follow the steps below to change the Auto Power Off setting.

- 1 Press the  (SETTING) button on the operator panel.
- 2 Press the  button to select [Admin Setup] and press the  (OK) button.
- 3 Enter the administrator password.





The factory default administrator name and password are "admin" and "999999" respectively.

- 4 Select [Enter], and then press the  (OK) button.
- 5 Press  or  several times and press [User Install].
- 6 Press [Power Setup].



- 7 Press [Auto Power Off].
- 8 Select the value.

Setting the Length of Idle Time Before Auto Power Off Works

- 1 Press the  (SETTING) button on the operator panel.
- 2 Press the  button to select [Admin Setup] and press the  (OK) button.
- 3 Enter the administrator password.



The factory default administrator name and password are "admin" and "999999" respectively.

- 4 Select [Enter], and then press the  (OK) button.
- 5 Press  or  several times and press [Manage Unit].
- 6 Press [Power Save].
- 7 Press [Auto Power Off Time].
- 8 Select transition time.

Specifications

This section describes the specifications of the machine.

- [General Specifications](#)
- [Copier Specifications](#)
- [Fax Specifications](#)
- [Scanner Specifications](#)
- [Printing Specifications](#)
- [Network Specifications](#)
- [Wireless LAN Specifications \(Option\)](#)

General Specifications

MFP Model	Model Number
MC563/ES5463 MFP	N36401B

Item	MC563/ES5463 MFP	
CPU	ARM 667MHz	
Memory	DDR3 32bit 1GB	
ROM	3 GB	
Weight (including consumables)	Approx. 31 kg	
Dimensions (W x D x H)	427 x 576 x 472 mm	
Power supply	N36401B: 230V AC +/-10	
Power consumption	Typical operation	640 W
	Idle	100 W
	Peak	1270 W
	Power save mode	Less than 20 W
	Sleep mode	Less than 7.8 W
	Deep sleep mode	Less than 1.5 W
	Auto power off mode	Less than 0.5 W
Operating condition	Operating	Temperature : 10 - 32°C, Humidity : 20 - 80% RH
	Idle	Temperature : 0 - 43°C, Humidity : 10 - 90% RH
Interface	USB 2.0, Ethernet 10BASE-T/100BASE-TX/1000BASE-T, Host USB×2 IEEE802.11 b/g/n/a Wireless LAN (Option)	
Display	3.5 inch mono graphic panel	
Supported OS	Windows 10/Windows 8.1/Windows Server 2012 R2/ Windows 8/Windows Server 2012/Windows 7/ Windows Vista/Windows Server 2008 R2/Windows Server 2008 Mac OS X 10.8.5 to 10.11	

Copier Specifications

Item		MC563/ES5463 MFP
Document size	ADF	A4, A5, A6, B5, B6, Letter, Legal 13/13.5/14, Executive, Statement, 8.5 SQ, Folio
	Document glass	A4, A5, A6, B5, B6, B6 Half, Letter, Executive, Statement, 8.5 SQ, 16K (197 x 273 mm, 195 x 270 mm, 184 x 260 mm), Index Card, 4 x 6 inches, 5 x 7 inches, Envelopes
First copy time	Color	12 seconds
	Mono	12 seconds
Copies		Up to 99
Copy speed	Color	Up to 30 cpm
	Mono	Up to 30 cpm

Fax Specifications

Item		MC563/ES5463 MFP
Compatibility		ITU-T G3/Super G3
Compression method		MH, MR, MMR, JBIG
Modem speed		Up to 33.6 Kbps
Lines		PSTN, PBX
Line interface		RJ11 x 2 (Line/TEL)
Transmission speed		Approx. 2 seconds/page (ITU-T no.1, JBIG, Normal)
Stored document memory size		256 MB
Storage document capacity		Up to 8192 pages (ITU-T no.1, MMR, Normal)
Resolution	Normal	8 dots x 3.85 line/mm
	Fine	8 dots x 7.7 line/mm
	Photo	8 dots x 7.7 line/mm
	Extra-Fine	8 dots x 15.4 line/mm

Scanner Specifications

Item		MC563/ES5463 MFP
Type		Document Glass with ADF function
Image sensor		Color CIS
Light source		LED
Scanning resolution		600 × 600 dpi, 600 × 300 dpi
Document thickness	ADF	64 - 105 g/m ² (17 - 28 lb)
	Document glass	20 mm
ADF document capacity		50 sheets (80 g/m ²) and total thickness 5 mm or lower
Scanning area	ADF	Simplex : Up to 216 × 356 mm (8.5 x 14 inches) Duplex : Up to 216 × 356 mm (8.5 x 14 inches)
	Document glass	216 x 297 mm (8.5 x 11.7 inches) or less
Scanning speed	Color	Approx. 30 pages/minute (A4, 600 x 300 dpi, ADF simplex)
	Mono	Approx. 30 pages/minute (A4, 600 x 600 dpi, ADF simplex)

Printing Specifications

Item		MC563/ES5463 MFP
Printing method		Dry electrophotographic recording method with LED (Light-emitting diode)
Page-description language		PostScript 3, PCL5c, PCL6 (XL), EPSON FX, IBM ProPrinter, XPS, PDF (v1.7 or earlier)
Resident fonts		PCL: 91 European fonts PS: 80 European fonts
Resolution		1200 x 1200 dpi, 600 × 600 dpi
Color		Yellow, Magenta, Cyan, Black
Print speed		<ul style="list-style-type: none"> • A4 Simplex: Up to 30 ppm Duplex: Up to 16 ppm (mono), 14 ppm (color) • Letter Simplex: Up to 31 ppm Duplex: Up to 16 ppm (mono), 14 ppm (color)
First print out time	Color	Approx. 7.5 seconds (A4)
	Mono	Approx. 7.5 seconds (A4)
Paper size	Tray 1	Legal 13/13.5/14, Letter, Executive, A4, A5, A6, B5, B6, Statement, 8.5 SQ, Folio, 16K (197 x 273 mm, 195 x 270 mm, 184 x 260 mm), Custom size
	Additional tray unit (Optional)	Legal 13/13.5/14, Letter, Executive, A4, A5, B5, 8.5 SQ, Folio, 16K (197 x 273 mm, 195 x 270 mm, 184 x 260 mm), Custom size
	MP Tray	Legal 13/13.5/14, Letter, Executive, A4, A5, A6, B5, B6, B6 Half, Statement, 8.5 SQ, Folio, Index card (3x5inches), 4 x 6 inches, 5 x 7 inches, Banner up to 1321 mm (52 inches), 16K (197 x 273 mm, 195 x 270 mm, 184 x 260 mm), C5, DL, Com-9, Com-10, Monarch, Custom size
	Duplex Printing	Legal 13/13.5/14, Letter, Executive, A4, A5, B5, 8.5 SQ, Folio, 16K (197 x 273 mm, 195 x 270 mm, 184 x 260 mm), Custom size
	Custom size	<ul style="list-style-type: none"> • Tray 1 100 - 216 mm (W), 148 - 356 mm (L) (3.9 - 8.5 inches (W), 5.8 - 14.0 inches (L)) • Additional tray unit (optional) 148 - 216 mm (W), 210 - 356 mm (L) (5.8 - 8.5 inches (W), 8.2 - 14.0 inches (L)) • MP tray 64 - 216 mm (W), 90 - 1321 mm (L) (2.5 - 8.5 inches (W), 3.5 - 52 inches (L)) • Duplex 148 - 216 mm (W), 210 - 356 mm (L) (5.8 - 8.5 inches (W), 8.2 - 14.0 inches (L))
Media type		Plain paper (64 g/m ² - 220 g/m ²), Envelopes, Label
Feeding method		Automatic feeding from Tray 1, MP tray and Additional tray unit (optional) Manual feeding from MP tray

Item	MC563/ES5463 MFP
Paper loading capacity	<ul style="list-style-type: none"> • Tray 1 250 sheets (less than 80 g/m²), total thickness 25 mm or lower. • MP tray 100 sheets (less than 80 g/m²) and total thickness 10 mm or lower, 10 envelopes (85 g/m²). • Additional tray unit (optional) 530 sheets of Standard paper /80 g/m² and total thickness 53 mm or lower.
Output method	Output tray/Rear output tray
Paper output capacity	<ul style="list-style-type: none"> • Output Tray 150 sheets (less than 80 g/m²) • Rear Output Tray 100 sheets (less than 80 g/m²)
Print guaranteed area	6.35 mm or more from the paper edge (not applicable to special media such as envelopes)
Print precision	Print beginning: ± 2 mm, paper skew: ± 1 mm/100 mm Image expansion: ± 1 mm/100 mm (80 g/m ²)
Warm-up time	<ul style="list-style-type: none"> • From power on 35 seconds (at room temperature 25°C, rated voltage) • From sleep mode 38 seconds (at room temperature 25°C, rated voltage)
Usage Environment Conditions	<ul style="list-style-type: none"> • When in operation 10 - 32°C/ Relative Humidity of 20 - 80% (maximum wet bulb temperature of 25°C, maximum dry bulb temperature of 2°C) • When not in operation 0 - 43°C/ Relative Humidity of 10 - 90% (maximum wet bulb temperature of 26.8°C, maximum dry bulb temperature of 2°C)
Conditions for the guarantee of print quality	<ul style="list-style-type: none"> • Operating Range Temperature 10°C, humidity 20 to 80% RH Temperature 32°C, humidity 20 to 60% RH Humidity 20% RH, temperature 10 to 32°C Humidity 80% RH, temperature 10 to 27°C • Full-color Print Quality Assured Range Temperature 17 to 27°C, humidity 50 to 70% RH
Consumables	Toner cartridges, Image drums, Belt unit, Fuser unit

Network Specifications

Item	MC563/ES5463 MFP
Interface	Ethernet 10BASE-T/100BASE-TX/1000BASE-T, IEEE802.11 a/b/g/n Wireless LAN
Protocol	TCP/IPv4, TCP/IPv6, NetBIOS over TCP, LPR, Port9100, IPP, FTP, HTTP, TELNET, SMTP, POP3, SNMPv1/v3, DHCP, DHCPv6, DNS, DDNS, UPnP, WINS, Bonjour, SNTP, LLTD, Web Services Discovery (WSD), SSL/TLS, IPSec, CIFS, SMB (Version 1.0), LDAPv3, Kerberos, IEEE802.1X, AirPrint, Google Cloud Print

Wireless LAN Specifications (Option)

Item	MC563/ES5463 MFP
Wireless LAN standard	IEEE802.11a/b/g/n conformity (2.4 GHz / 5 GHz)
Security	Disable, WEP, WPA-PSK, WPA2-PSK, WPA-EAP, WPA2-EAP

Regulatory wireless LAN statements

- FCC Statement
- IC Statement
- Europe-CE Declaration of conformity.

FCC statement

FCC WARNING

Changes or modifications not expressly approved by the party responsible for compliance could void the user's authority to operate the equipment.

Note: This equipment has been tested and found to comply with the limits for a Class B digital device, pursuant to part 15 of the FCC Rules. These limits are designed to provide reasonable protection against harmful interference in a residential installation. This equipment generates, uses and can radiate radio frequency energy and, if not installed and used in accordance with the instructions, may cause harmful interference to radio communications. However, there is no guarantee that interference will not occur in a particular installation. If this equipment does cause harmful interference to radio or television reception, which can be determined by turning the equipment off and on, the user is encouraged to try to correct the interference by one or more of the following measures:

- Reorient or relocate the receiving antenna.
- Increase the separation between the equipment and receiver.
- Connect the equipment into an outlet on a circuit different from that to which the receiver is connected.
- Consult the dealer or an experienced radio/TV technician for help.

This transmitter must not be co-located or operating in conjunction with any other antenna or transmitter.

IC statement

This device complies with Part 15 of FCC Rules and Industry Canada licence-exempt RSS standard(s). Operation is subject to the following two conditions: (1) this device may not

cause interference, and (2) this device must accept any interference, including interference that may cause undesired operation of this device.

Le présent appareil est conforme aux la partie 15 des règles de la FCC et CNR d'Ubdustrie Canada applicables aux appareils radio exempts de licence. L'exploitation est autorisée aux deux conditions suivantes : (1) l'appareil ne doit pas produire de brouillage, et (2) l'utilisateur de l'appareil doit accepter tout brouillage radioélectrique subi, même si le brouillage est susceptible d'en compromettre le fonctionnement.

This Class [B] digital apparatus complies with Canadian ICES-003.

Cet appareil numérique de la classe [B] est conforme à la norme NMB-003 du Canada.

Caution (FCC/IC):

5.15-5.25 GHz band is restricted to indoor operations only.

La bande 5150-5250 MHz est restreints à une utilisation à l'intérieur.

This equipment complies with FCC/IC radiation exposure limits set forth for an uncontrolled environment and meets the FCC radio frequency (RF) Exposure Guidelines and RSS-102 of the IC radio frequency (RF) Exposure rules. This equipment should be installed and operated keeping the radiator at least 20 cm or more away from person's body.

Cet équipement est conforme aux limites d'exposition aux rayonnements énoncées pour un environnement non contrôlé et respecte les règles les radioélectriques (RF) de la FCC lignes directrices d'exposition et d'exposition aux fréquences radioélectriques (RF) CNR-102 de l'IC. Cet équipement doit être installé et utilisé en gardant une distance de 20 cm ou plus entre le dispositif rayonnant et le corps.

Europe - CE Declaration of Conformity



This equipment complies with the essential requirements of the European Union directive 2014/53/EU.

The telecommunications functionality of this product may be used in the following EU and EFTA countries: Austria, Belgium, Bulgaria, Cyprus, Czech Republic, Denmark, Estonia, Finland, France, Germany, Greece, Hungary, Iceland, Ireland, Italy, Latvia, Liechtenstein, Lithuania, Luxembourg, Malta, Netherlands, Norway, Poland, Portugal, Romania, Slovak Republic, Slovenia, Spain, Sweden, Switzerland, Turkey and United Kingdom.

Menu List

Reports

- Configuration
- System
 - File List
 - Demo Page
 - Error Log
 - Scan To Log
 - Usage Report
 - Network Information
 - Supplies Report
 - Job Log
- Fax
 - Speed Dial List
 - Group List
 - Fax Tx Log
 - Fax Rx Log
 - Fax Tx/Rx Log
 - Daily Tx/Rx Log Report
 - Fcode Box List
 - Block Junk Fax List
- E-mail/Internet Fax
 - Journal Report
 - Address Book
- Print
 - PCL Font List
 - PSE Font List
 - PPR Font List
 - FX Font List
 - Color Tuning Pattern
 - Color Profile List

Paper Setup

- Tray1
 - Paper Size (A4)
 - Media Type (Plain)
 - Media Weight (Medium)
- Tray2*
 - Paper Size (A4)
 - Media Type (Plain)
 - Media Weight (Medium)
- Tray3*
 - Paper Size (A4)
 - Media Type (Plain)
 - Media Weight (Medium)
- MP Tray
 - Paper Size (A4)
 - Media Type (Plain)
 - Media Weight (Medium)
 - MP Tray Usage (When Mismatching)
- Select Tray
 - Fax
 - Tray 1 (ON)
 - Tray 2* (ON)
 - Tray 3* (ON)
 - MP Tray (OFF)
 - Copy
 - Tray 1 (ON(Prior))
 - Tray 2* (ON)
 - Tray 3* (ON)
 - MP Tray (OFF)
- Paper Feed (Tray 1)
- Auto Tray Switch (ON)
- Tray Sequence (Down)
- Duplex Last Page (Skip Blank Page)

(): Factory default
* : Option

Address Book

- E-mail Address
 - Edit/Register
 - Name
 - E-mail Address
 - Group No.
 - Delete
 - Sort by Name
 - Sort by Number
 - Search
- E-mail Group
 - Edit/Register
 - Name
 - Address No.
 - Delete
 - Sort by Name
 - Sort by Number
 - Search

Phone Book

- Speed Dial
 - Edit/Register
 - Name
 - Fax Number
 - Group No.
 - Delete
 - Sort by Name
 - Sort by Number
 - Search
- Group No.
 - Edit/Register
 - Name
 - Speed Dial
 - Delete
 - Sort by Name
 - Sort by Number
 - Search

Profile

- Edit/Register
 - Profile Name
 - Protocol
 - Target URL
 - Port No.
 - User Name
 - Password
 - CIFS Character Set
 - Scan Size
 - Image Settings
 - Density
 - Document Type
 - Background Removal
 - Show-Through Removal
 - Resolution
 - Contrast
 - Hue
 - Saturation
 - RGB
 - File Name
 - Grayscale
 - File Format
 - Color
 - Mono (Grayscale)
 - Mono (Binary)
 - Encrypted PDF
 - Compression Rate / Color, Grayscale
 - Edge Erase
 - Width
- Delete
- Sort By Name
- Sort By Number
- Search

Network Scan Destination

- Edit/Register
 - Destination
 - Destination Address
 - Port No.
- Delete
- Sort By Name
- Sort By Number
- Search

Store Document Settings

- Store
 - Fcode Bulletin Board
- Delete
 - Fcode Bulletin Board
- Print
 - Fcode Box
 - Received Documents

View Information

- System Information
 - Serial No.
 - Asset No.
 - Lot No.
 - Firmware Version
 - CU Version
 - PU Version
 - Panel Version
 - Total Memory
 - Flash Memory
- Network
 - Network Information
 - Wireless(Infrastructure) Information*

Easy Setup

- 1. Date/Time Setting
 - Time Zone
 - Daylight Saving
 - Day and Time
 - Server
 - SNTP Server (Primary)
 - SNTP Server (Secondary)
 - Manual
 - Date
 - Time
- 2. Fax Setting
 - Fax Number
 - Sender ID
- 3. Network Setting
 - Auto
 - Manual
 - IP Address
 - Subnet Mask
 - Default Gateway
 - DNS Server (Primary)
 - DNS Server (Secondary)
 - WINS Server (Primary)
 - WINS Server (Secondary)
- 4. E-mail Setting
 - Mail Server Address
 - Sender's Address(From)
 - Receive Setting
 - Authentication Method

AirPrint (Enable)

Google Cloud Print

- Register to Google Cloud Print
- Google Cloud Print Settings
 - Using Cloud Service
 - DNS Server (Primary)
 - DNS Server (Secondary)
 - Proxy
 - Proxy Server
 - Proxy Server Port No.
 - Proxy User ID
 - Proxy Password

Wireless(Infrastructure) Setting*

- Admin Password
 - Wireless(Infrastructure)
 - Network Setting
 - Automatic Setup (WPS)
 - Wireless Network Selection
 - Wireless reconnection

Admin Setup

Copy Setup

Default Settings

- Scan Size (A4)
- Duplex Copy (OFF(Simplex))
- Zoom (100%)
- Sort (ON)
- Image Settings
 - Density (0)
 - Document Type (Text&Photo)
 - Resolution (Normal)
 - Background Removal (Auto)
 - Show-Through Removal (Middle)
 - Contrast (0)
 - Hue (0)
 - Saturation (0)
 - RGB
 - Red (0)
 - Green (0)
 - Blue (0)
- Direction (Portrait)
- ID Card Copy (OFF)
- Continuous Scan (OFF)
- Mixed Size (OFF)
- Margin (OFF)
- Edge Erase (ON)

Fax Setup

Default Settings

- Resolution (Normal)
- Background Removal (Auto)
- Density (0)
- Scan Size (A4)
- Continuous Scan(Document Glass) (OFF)
- Continuous Scan(ADF) (OFF)
- Edge Erase (OFF)
- TTI (ON)
- Transmit Confirmation Report (OFF)
- Memory Tx (ON)

Fcode Box

- Edit/Register
 - Confidential Box
 - Box Name
 - Sub-Address
 - Hold Time
 - I.D.Code
 - Bulletin Box
 - Box Name
 - Sub-Address
- Delete

Security Function

- ID Check Tx (OFF)
- Broadcast Destination (ON)
- Confirm Dial (OFF)
- Secure Receive
 - Setting (OFF)
 - Password

Other Settings

- Redial Tries (2 times)
- Redial Interval (1 minute)
- Block Junk Fax List
 - Setting (OFF)
- Ring Response (1 Ring)
- Dialing Pause Duration (2 seconds)

- Rx Reduc. Rate (*Auto*)
- Reduc. Margin (*24 mm*)
- ECM Mode (*ON*)
- PreFix
- Received Time Stamp (*OFF*)
- Print Check Message (*ON*)
- Duplex (*OFF*)
- Distant Station Priority (*Type 1*)
- Fax Setting
 - Service Bit (*OFF*)
 - Country Code (*International*)
 - A/R Full Print (*ON*)
 - Daily Tx/Rx Log Report
 - Setting (*OFF*)
 - Print time (*0 Hour 0 Minute*)
 - H/Modem Rate(For Tx) (*33.6 Kbps*)
 - H/Modem Rate(For Rx) (*33.6 Kbps*)
 - PBX Line (*OFF*)
 - Forwarding Setting (*OFF*)
 - TAD Mode (*Type 3*)
 - Tel Priority Mode (*OFF*)
 - CNG Detection (*OFF*)
 - T/F Timer Programming (*35 seconds*)
 - Soft Ringer Volume (*High*)
 - Remote Receive Number (*OFF*)
- FaxServer Function
 - Environmental Settings
 - FaxServer Function (*OFF*)
 - Prefix
 - Suffix (*@faxserver*)
 - Text (*OFF*)
 - Default Settings
 - Scan Size (*A4*)
 - Density (*0*)
 - Resolution (*Normal*)
 - Background Removal (*Auto*)
 - Continuous Scan (*OFF*)
 - Compression Rate (*Low*)
 - Security Function
 - Broadcast Destination (*ON*)
 - Confirm Dial (*OFF*)
- Internet Fax Setup
 - Default Settings
 - Scan Size (*A4*)
 - Density (*0*)
 - Resolution (*Normal*)
 - Background Removal (*Auto*)
 - Continuous Scan (*OFF*)
 - Compression Rate (*Low*)
- Scanner Setup
 - Default Settings
 - Scan Size (*A4*)
 - Direction (*Portrait*)
 - Image Settings
 - Density (*0*)
 - Document Type (*Text&Photo*)
 - Background Removal (*Auto*)
 - Show-Through Removal (*Middle*)
 - Resolution (*200dpi*)
 - Contrast (*0*)
 - Hue (*0*)
 - Saturation (*0*)

- └─ RGB
 - └─ Red (0)
 - └─ Green (0)
 - └─ Blue (0)
- └─ Continuous Scan (OFF)
- └─ Grayscale (OFF)
- └─ File Format
 - └─ Color (Multi-PDF)
 - └─ Mono (Grayscale) (Multi-PDF)
 - └─ Mono (Binary) (Multi-PDF)
- └─ Encrypted PDF Setting
 - └─ Document Open Password
 - └─ Permissions Password
 - └─ Display Default Password (Disable)
- └─ Compression Rate / Color,Grayscale (High)
- └─ Edge Erase (OFF)
- └─ E-mail Setup
 - └─ File Name
 - └─ Template
 - └─ Edit Subject
 - └─ Edit Body
 - └─ From / Reply To
 - └─ From
 - └─ E-mail Sender ID
 - └─ Reply To
 - └─ Broadcast Destination (ON)
 - └─ MDN Response (OFF)
 - └─ A/R Full Print (OFF)
 - └─ MCF Report (OFF)
 - └─ Timeout Of MCF Report (15 minutes)
 - └─ Print Check Message (OFF)
- └─ USB Memory Setup
 - └─ File Name
- └─ TWAIN Setup
 - └─ Network TWAIN (ON)
 - └─ Port No. (9967)
- └─ WSD Scan Setup
 - └─ WSD Scan (Enable)
 - └─ Binding (Long Edge Bind)
- └─ PC Scan Mode (Simple Scan Mode)
- └─ Scanner Adjust
 - └─ Scanner Calibration
 - └─ Adjust Scan Position
 - └─ FBS
 - └─ Side Reg. (0)
 - └─ Front Edge (0)
 - └─ ADF(Front-side)
 - └─ Side Reg. (0)
 - └─ Front Edge (0)
 - └─ Back Edge (0)
 - └─ ADF(Back-side)
 - └─ Front Edge (0)
 - └─ Back Edge (0)
 - └─ Adjust ADF Scan Position (0)
- └─ Print From USB Memory Setup
 - └─ Default Settings
 - └─ Paper Feed (Tray 1(A4))
 - └─ Copies (1 Set(s))
 - └─ Duplex (OFF)
 - └─ Fit (ON)

- Print Setup
 - Print Menu
 - Print Setup
 - Copies (1 Set)
 - Duplex (OFF)
 - Media Check (Enable)
 - Override A4/Letter (Yes)
 - Resolution (600dpi)
 - Toner Save Level (OFF)
 - Mono-Print Mode (Auto)
 - Orientation (Portrait)
 - Edit Size (Cassette Size)
 - Trapping (OFF)
 - Width
 - Length
 - Printer Adjust
 - Manual Timeout (60 seconds)
 - Timeout Injob (40 seconds)
 - Timeout Local (40 seconds)
 - Timeout Network (90 seconds)
 - Print Mode Without Color Toner (Alarm)
 - Jam Recovery (Enable)
 - Paper Black Setting (0)
 - Paper Color Setting (0)
 - SMR Setting
 - SMR Setting(Black) (0)
 - SMR Setting(Yellow) (0)
 - SMR Setting(Magenta) (0)
 - SMR Setting(Cyan) (0)
 - BG Setting
 - BG Setting(Black) (0)
 - BG Setting(Yellow) (0)
 - BG Setting(Magenta) (0)
 - BG Setting(Cyan) (0)
 - HU Setting (OFF)
 - VL Cleaning
 - Gloss Mode (OFF)
 - Print Position Adjust
 - Tray 1
 - X Adjust (0 mm)
 - Y Adjust (0 mm)
 - Duplex X Adjust (0 mm)
 - Duplex Y Adjust (0 mm)
 - Tray 2*
 - X Adjust (0 mm)
 - Y Adjust (0 mm)
 - Duplex X Adjust (0 mm)
 - Duplex Y Adjust (0 mm)
 - Tray 3*
 - X Adjust (0 mm)
 - Y Adjust (0 mm)
 - Duplex X Adjust (0 mm)
 - Duplex Y Adjust (0 mm)
 - MP Tray
 - X Adjust (0 mm)
 - Y Adjust (0 mm)
 - Duplex X Adjust (0 mm)
 - Duplex Y Adjust (0 mm)
 - Drum Cleaning (OFF)
 - Hex Dump (OFF)

- Color Menu
 - Density Control (*Auto*)
 - Adjust Density
 - Color Tuning/Print Pattern
 - Cyan Tuning
 - Cyan Highlight (*0*)
 - Cyan Mid-Tone (*0*)
 - Cyan Dark (*0*)
 - Magenta Tuning
 - Magenta Highlight (*0*)
 - Magenta Mid-Tone (*0*)
 - Magenta Dark (*0*)
 - Yellow Tuning
 - Yellow Highlight (*0*)
 - Yellow Mid-Tone (*0*)
 - Yellow Dark (*0*)
 - Black Tuning
 - Black Highlight (*0*)
 - Black Mid-Tone (*0*)
 - Black Dark (*0*)
 - Color Density
 - Cyan Density (*0*)
 - Magenta Density (*0*)
 - Yellow Density (*0*)
 - Black Density (*0*)
 - Adjust Registration
 - Ink Simulation (*OFF*)
 - UCR (*Low*)
 - CMY100% Density (*Disable*)
 - CMYK Conversion (*ON*)
- System Configuration Menu
 - Personality (*Auto Emulation*)
 - Alarm Release (*Manual*)
 - Auto Continue (*OFF*)
 - Error Report (*OFF*)
- PCL Setup
 - Font Source (*Resident*)
 - Font No. (*10*)
 - Font Pitch (*10 CPI*)
 - Font Height (*12 point(s)*)
 - Symbol Set (*PC-8*)
 - A4 Print Width (*78 Column*)
 - White Page Skip (*OFF*)
 - CR Function (*CR*)
 - LF Function (*LF*)
 - Print Margin (*Normal*)
 - True Black (*OFF*)
 - Pen Width Adjust (*ON*)
 - Tray ID#
 - Tray 1 (*1*)
 - Tray 2* (*5*)
 - Tray 3* (*20*)
 - MP Tray (*4*)
- PS Setup
 - L1 Tray (*Type 1*)
 - Network PS-Protocol (*RAW*)
 - USB PS-Protocol (*RAW*)
 - PDF Paper Size (*Current Tray Size*)
 - PDF Print Mode (*Quality priority*)

- XPS Setup
 - DigitalSignature (*OFF*)
 - DiscardControl (*Auto*)
 - MC Mode (*ON*)
 - Unzip Mode (*Speed*)
 - White Page Skip (*OFF*)
- SIDM Setup
 - SIDM Manual ID# (2)
 - SIDM Manual2 ID# (3)
 - SIDM MP Tray ID# (4)
 - SIDM Tray1 ID# (1)
 - SIDM Tray2 ID# *(5)
 - SIDM Tray3 ID# *(6)
- IBM PPR Setup
 - Character Pitch (*10CPI*)
 - Font Condense (*12CPI to 20CPI*)
 - Character Set (*SET-2*)
 - Symbol Set (*IBM-437*)
 - Letter O Style (*Disable*)
 - Zero Character (*Normal*)
 - Line Pitch (*6 LPI*)
 - White Page Skip (*OFF*)
 - CR Function (*CR*)
 - LF Function (*LF*)
 - Line Length (*80 Column*)
 - Form Length (*11.7 inch*)
 - TOF Position (*0 inch*)
 - Left Margin (*0 inch*)
 - Fit To Letter (*Disable*)
 - Text Height (*Same*)
- EPSON FX Setup
 - Character Pitch (*10 CPI*)
 - Character Set (*SET-2*)
 - Symbol Set (*IBM-437*)
 - Letter O Style (*Disable*)
 - Zero Character (*Normal*)
 - Line Pitch (*6 LPI*)
 - White Page Skip (*OFF*)
 - CR Function (*CR*)
 - Line Length (*80 Column*)
 - Form Length (*11.7 inch*)
 - TOF Position (*0 inch*)
 - Left Margin (*0 inch*)
 - Fit To Letter (*Disable*)
 - Text Height (*Same*)
- Private Print Setup
 - Verify job option (*Disable*)
 - Erase job option (*No Overwrite*)
 - Keep job for (*2hours*)
 - Job Limitation (*Disable*)
 - Job Password Authentication(*OFF*)
- Network Menu
 - Network Setup
 - Network Setting
 - Enabling Default Gateway (*Wired*)
 - Wired (*Enable*)
 - TCP/IP (*Enable*)
 - NetBIOS Over TCP (*Enable*)
 - IP Address Set (*Auto*)
 - IPv4 Address
 - Subnet Mask
 - Gateway Address

- DHCPv6 (*Disable*)
- DNS Server (Primary) (*0.0.0.0*)
- DNS Server (Secondary) (*0.0.0.0*)
- WINS Server (Primary) (*0.0.0.0*)
- WINS Server (Secondary) (*0.0.0.0*)
- Proxy (*Disable*)
- Proxy Server
- Proxy Server Port No. (*8080*)
- Proxy User ID
- Proxy Password
- Web (*Enable*)
- Telnet (*Disable*)
- FTP (*Disable*)
- SNMP (*Enable*)
- Network Scale (*Normal*)
- Gigabit Network (*Disable*)
- HUB Link Setting (*Auto Negotiate*)
- Wireless(Infrastructure) Setting*
 - Wireless(Infrastructure) (*Disable*)
 - Network Setting
 - Automatic setup (WPS)
 - Wireless Network Selection
 - Wireless reconnection
- Wireless(AP Mode) Setting*
 - Wireless(AP Mode) (*Disable*)
 - Automatic connection (push-button)
 - Manual Setup
 - SSID
 - Password
 - Connection Settings
 - SSID
 - Password
 - IPv4 Address
 - AP mode user settings (*Don't disclose user*)
- Factory Defaults
- Save Syslog
- Print Syslog
- Mail Server Setup
 - SMTP Server
 - SMTP Port (*25*)
 - SMTP Encryption (*None*)
 - Receive Setting (*Disable*)
 - POP3 Server
 - POP3 Port (*110*)
 - POP Encryption (*None*)
 - Authentication Method (*No Authentication*)
 - SMTP User ID
 - SMTP Password
 - POP User ID
 - POP Password
- LDAP Server Setting
 - Server Setting
 - LDAP Server
 - Port No. (*389*)
 - Timeout (*30 seconds*)
 - Max. Entries (*100 Entries*)
 - Search Root
 - Attribute
 - Name1 (*cn*)
 - Name2 (*sn*)
 - Name3 (*givenName*)

- E-mail Address (*mail*)
 - Additional Filter
 - Authentication
 - Method (*Anonymous*)
 - UserID
 - Password
 - Encryption (*None*)
- Secure Protocol Server Setting
 - Domain
- Manage Unit
 - Default Mode (*Copy*)
 - Operation Clear
 - Operation Timeout (*After 3 minutes*)
 - Clear After Job (*OFF*)
 - Sound Control
 - Key Touch Tone Volume (*Middle*)
 - Copy Completion Buzzer Volume (*Middle*)
 - Fax Buzzer Volume (*Middle*)
 - Paper Jam Error Buzzer Volume
 - Volume
 - Type
 - AirPrint Buzzer Volume (*Low*)
 - Local Interface
 - USB Menu
 - Soft Reset (*Disable*)
 - Speed (*480Mbps*)
 - Offline Receive (*Disable*)
 - Serial Number (*Enable*)
 - Connected Host (*Normal*)
 - System Setup
 - Access Control (*Disable*)
 - Unit of Measure (*Millimeter*)
 - Default Paper Size (*A4*)
 - Default Scan Size (*A4*)
 - Date Format (*dd/mm/yyyy*)
 - Allow All Reports To Print (*Disable*)
 - Near Life LED (*Enable*)
 - Near Life Status (*Enable*)
 - USB Memory Interface (*Enable*)
 - Panel Contrast (*0*)
 - Power Save
 - Power Save Time (*1 minute*)
 - Sleep Time (*15 minutes*)
 - Auto Power Off Time (*4 hours*)
 - Silent Mode (*ON*)
 - ECO Mode (*ON*)
 - Memory Setup
 - Receive Buffer Size (*Auto*)
 - Resource Save (*OFF*)
 - Storage Maintenance Setup
 - Check File System
 - Initial Lock (*Enable*)
 - Language Maintenance Setup
 - Select Language (*English*)
 - Initialize
 - Admin Password (*999999*)
 - Reset Settings
 - Job Log Setup
 - Clear Job Log

- L Print Statistics
 - ├ Maintenance Counter (*Disable*)
 - ├ Reset Main Counter
 - └ Reset Supplies Counter
- L User Install
 - ├ Time Zone (+00:00)
 - ├ Set Daylight Saving (*OFF*)
 - ├ Time Setup (02/01/2000 00:00)
 - ├ Auto Setup
 - ├ SNTP Server (*Primary*)
 - └ SNTP Server (*Secondary*)
 - └ Manual Setup
 - ├ Power Setup
 - ├ Auto Power Off (*Auto Config*)
 - └ Power Supply Return (*State Continue*)
 - ├ Office Document Mode (*Mode1*)
 - ├ High Humid Mode (*OFF*)
 - ├ Quiet Mode (*OFF*)
 - ├ Drum Near Life Timing (1000)
 - ├ Fuser Near Life Timing (1000)
 - ├ Belt Near Life Timing (1000)
 - ├ MF(Tone)/DP(Pulse) (*Tone*)
 - ├ Reception Mode (*Fax Ready Mode*)
 - ├ DRD Type (*Type 1*)
 - ├ Dial Tone Detection (*OFF*)
 - ├ Busy Tone Detection (*ON*)
 - ├ Monitor Control (*OFF*)
 - ├ Monitor Volume (*Middle*)
 - ├ TTI Register/Edit
 - ├ Standard TTI (*TTI 1*)
 - ├ TTI Number
 - ├ TTI Calendar Type (*dd/mm/yyyy*)
 - ├ Super G3 (*ON*)
 - ├ Wireless Module (*Disable*)
 - ├ Erase Privacy Data
 - ├ Business Phone Setup
 - ├ Business Phone Cooperation (*Disable*)
 - ├ Connection IP Address (*0.0.0.0*)
 - └ Connection Port No. (*59000*)

Status Menu

- System Status
- Device Information
 - Job Lists
 - Fax Job View/Cancel
 - Supplies Status
 - Black Drum (100%)
 - Cyan Drum (100%)
 - Magenta Drum (100%)
 - Yellow Drum (100%)
 - Belt (100%)
 - Fuser (100%)
 - K Toner(7.0K) (100%)
 - C Toner(6.0K) (100%)
 - M Toner(6.0K) (100%)
 - Y Toner(6.0K) (100%)
 - Counter
 - Print Count
 - Tray 1 (00000000)
 - Tray 2* (00000000)
 - Tray 3* (00000000)
 - MP Tray (00000000)
 - Color (00000000)
 - Mono (00000000)
 - Scan Count
 - Total Scanned Pages (00000000)
 - Scanned Pages (00000000)
 - Total Scanned Pages (ADF) (00000000)
 - Scanned Pages (ADF) (00000000)
 - Wireless Information*

Contact Us

Italia www.oki.com/it
Français www.oki.com/fr
Deutschland www.oki.com/de
United Kingdom www.oki.com/uk
Ireland www.oki.com/ie
España www.oki.com/es
Portuguesa www.oki.com/pt
Sverige www.oki.com/se
Danmark www.oki.com/dk
Norge www.oki.com/no
Suomi www.oki.com/fi
Nederland www.oki.com/nl
België/Belgique www.oki.com/be
Österreich www.oki.com/at
Schweiz/Suisse/Svizzera www.oki.com/ch
Polska www.oki.com/pl
Česká www.oki.com/cz
Slovenská www.oki.com/sk
Magyarország www.oki.com/hu
Россия www.oki.com/ru
Україна www.oki.com/ua
Türkiye'ye www.oki.com/tr
Serbia www.oki.com/rs
Croatia www.oki.com/hr
Greece www.oki.com/gr
Romania www.oki.com/ro
OKI Europe www.oki.com/eu

Singapore www.oki.com/sg/
Malaysia www.oki.com/my/
ประเทศไทย www.oki.com/th/printing/
Australia www.oki.com/au/
New Zealand www.oki.com/nz/
United States www.oki.com/us/
Canada www.oki.com/ca/
Brasil www.oki.com/br/printing
México www.oki.com/mx/
Argentina www.oki.com/la/
Colombia www.oki.com/la/
Other countries www.oki.com/printing/

