

ES94x5 MFP Series Paper Handling Accessories

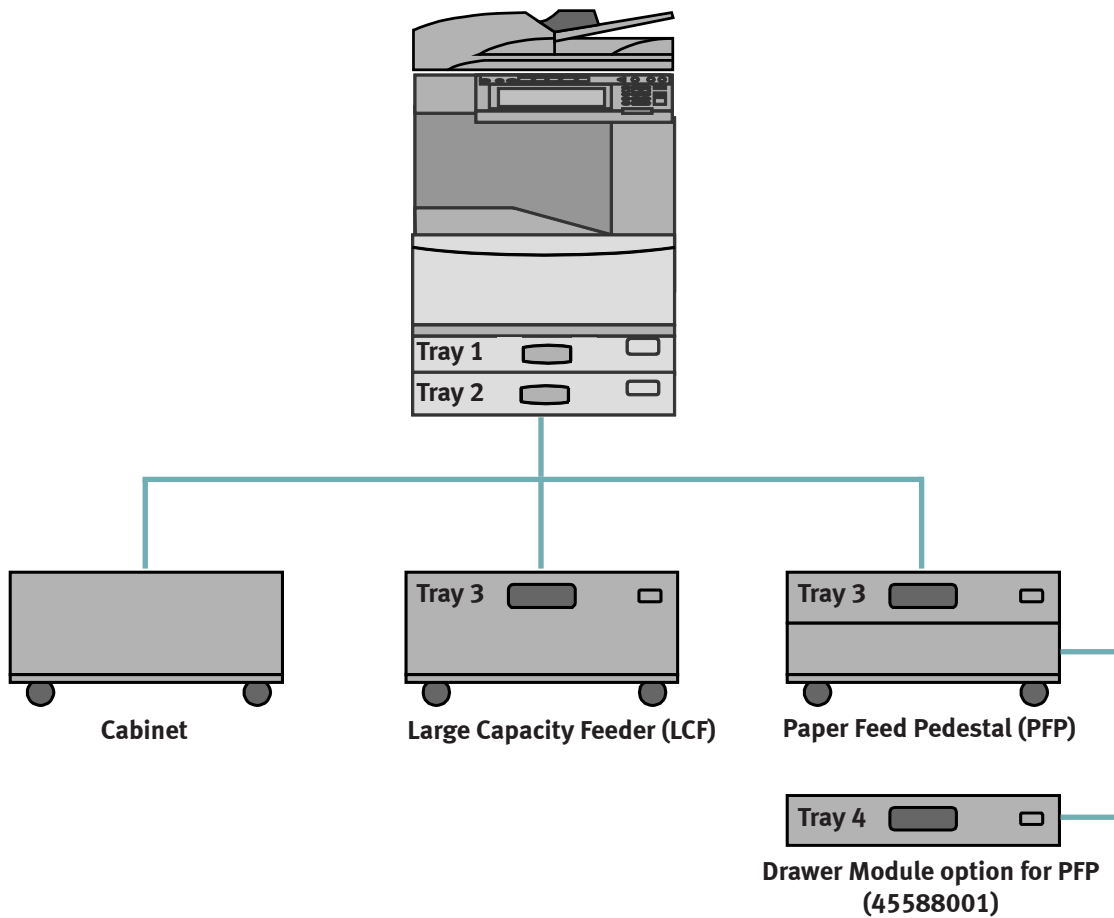

Choose the correct Paper input configuration to meet your business needs.



Large Capacity Feeder (LCF) - Tray 3	
Choose the LCF to provide a 3rd, 2,000 sheet paper tray for efficient printing of high volumes of A4/Letter documents.	
Paper Size	A4, LT
Paper Weight	64 to 105gsm
Paper Capacity	2,000 sheets 80gsm, stack height 110mm x 2

Paper Feed Pedestal (PFP) - Tray 3	
Choose the PFP to provide a 3rd paper tray and the option to add an additional 4th paper tray (Draw Module) for flexibility.	
Paper Size	A3, A4, A4-R, A5-R, B4, B5, B5-R, LD, LG, LT, LT-R, ST-R, 8K, 16K, 16K-R, Folio, Computer, 13" LG, 8.5" x 8.5"
Paper Weight	60 to 163gsm
Paper Capacity	550 sheets 80gsm, stack height 60.5mm

Draw Module option for PFP – Tray 4	
Choose the 4th paper tray (Draw Module) for additional paper capacity or additional paper feeding flexibility.	
Paper Size	A3, A4, A4-R, A5-R, B4, B5, B5-R, LD, LG, LT, LT-R, ST-R, 8K, 16K, 16K-R, Folio, Computer, 13" LG, 8.5" x 8.5"
Paper Weight	60 to 163gsm
Paper Capacity	550 sheets 80gsm, stack height 60.5mm

ES9455 MFP - Paper Output Accessories

The ES9455 MFP has been designed to provide the flexibility to choose the most efficient document finishing to maximise productivity in your application.

Saddle-Stitch Finisher (SSF) - Material No. 45587201

Tray 1 - Movable Tray

- Simple Stack mode
- Job Offset mode
- Staple Stack mode
Staple-2400 (44954102)
- Punch Mode (option)

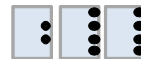

Tray 2 - Saddle Tray

- Staple, Fold & Stack mode
Staple-600 (44954104)

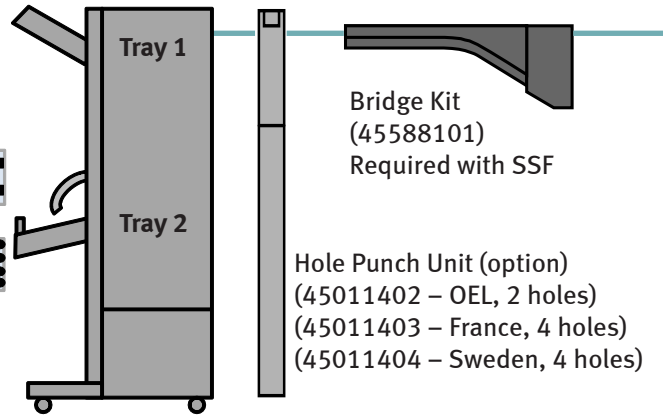

Job Separator - Material No. 45588201

Separator Tray

- Simple Stack mode



Inner Finisher - Material No. 45587001

Tray 1 - Stationary Tray

- Simple Stack mode
- Punch Mode (option)

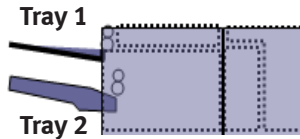
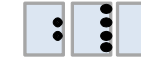

Tray 2 - Movable Tray

- Simple Stack mode
- Job Offset mode
- Staple Stack mode
Staple-2400 (44954102)
- Punch Mode (option)



Internal Hole Punch Unit (option)
 (45011202 - OEL, 2 holes)
 (45011203 - France, 4 holes)
 (45011204 - Sweden, 4 holes)

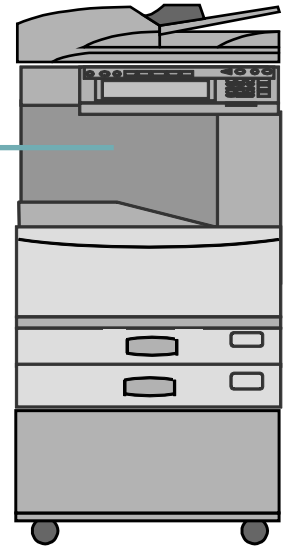

ES9465/75 MFP - Paper Output Accessories

The ES9465 MFP and ES9475 MFP Series offer a full range of document finishing options to suite your business needs and maximise productivity.

Saddle-Stitch Finisher (SSF) - Material No. 45587101

Tray 1 - Stationary Tray

- Simple Stack mode
- Punch Mode (option)

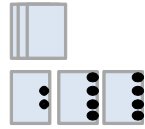

Tray 2 - Movable Tray

- Simple Stack mode
- Job Offset mode
- Staple Stack mode
Staple-2400 (44954102)
- Punch Mode (option)

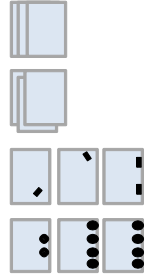

Tray 3 - Saddle Tray

- Staple, Fold & Stack mode
Staple-3100 (44954103)

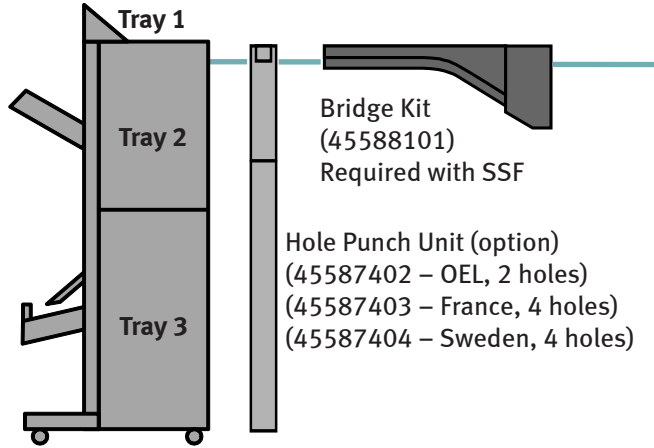

Multi-Staple Finisher (MSF) - Material No. 45587301

Tray 1 - Stationary Tray

- Simple Stack mode
- Punch Mode (option)

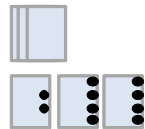

Tray 2 - Movable Tray

- Simple Stack mode
- Job Offset mode
- Staple Stack mode
Staple-2400 (44954102)
- Punch Mode (option)

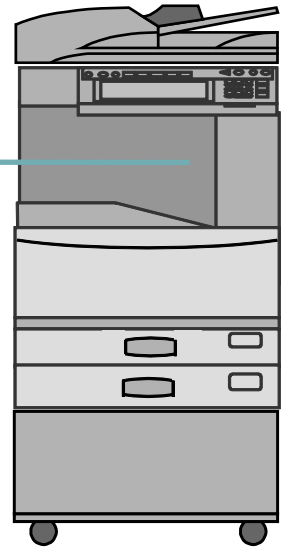
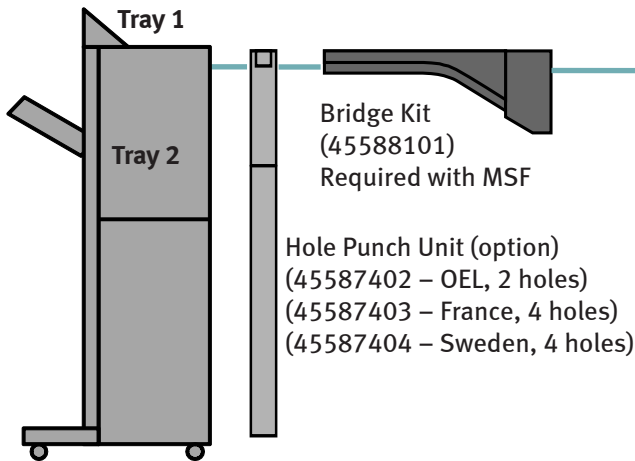
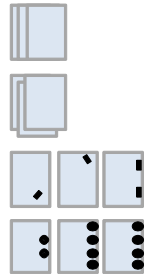

Job Separator - Material No. 45011902

Job Separator Tray

- Simple Stack mode



Inner Finisher - Material No. 45587001 (ES9465 MFP only)

Tray 1 - Stationary Tray

- Simple Stack mode
- Punch Mode (option)

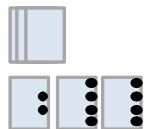

Tray 2 - Movable Tray

- Simple Stack mode
- Job Offset mode
- Staple Stack mode
Staple-2400 (44954102)
- Punch Mode (option)

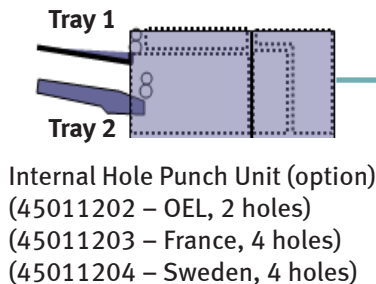
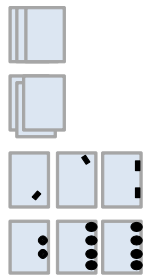

Specifications

Stacking	Paper Size	A5-R to A3
	Paper Weight	60 to 163gsm
	Paper Capacity	Upper Tray: 150 sheets 80gsm, stack height 25mm Lower Tray: 250 sheets 80gsm, stack height 40mm



Job Separator
ES9455 MFP: 45588201
ES9465/75 MFP: 45011902

Stacking	Paper Size	A5-R to A3
	Paper Weight	52 to 209gsm
	Paper Capacity	Tray 1: 100 x A4 / 50 x A3 sheets (80gsm) Tray 2: 500 x A4 / 250 x A3 sheets (80gsm)
Stapling	Stapling	50 x A4 sheets / 25 x A3 sheets (80gsm)
	Paper Weight	64 to 105gsm; 2 x 106 to 209gsm cover pages
	Staple-2400	3 x 5,000 staples cartridges per box (44954102)
Hole Punch (Option)	Versions	2 hole and 4 hole units available
	Paper Weight	64 to 128gsm
	Hole Diameter	6.5mm
	Hole Position	80 mm apart



Inner Finisher
ES9455/65 MFP: 45587001

Stacking	Paper Size	A5-R to A3
	Paper Weight	52 to 209gsm
	Paper Capacity	Tray 1: 1,000 x A4 / 500 x A3 sheets (80gsm)
Stapling	Stapling	50 x A4 sheets / 30 x A3 sheets (80gsm)
	Paper Weight	64 to 105gsm; 2 x 106 to 209gsm cover pages
	Staple-2400	3 x 5,000 staples cartridges per box (44954102)
Saddle-Stitch	Stapling	Up to 15 sheets (80gsm)
	Paper Weight	64 to 105gsm; 2 x 106 to 209gsm cover pages
	Paper Capacity	Tray 2: 20 booklets (5 sheets per book, folded)
	Staple-600	3 x 2,000 staples cartridges per box (44954104)
Hole Punch (Option)	Versions	2 hole and 4 hole units available
	Paper Weight	52 to 209gsm
	Hole Diameter	6.5mm
	Hole Position	80 mm apart



Saddle-Stitch Finisher
ES9455 MFP: 45587201

Stacking	Paper Size	A5-R to A3
	Paper Weight	52 to 209gsm
	Paper Capacity	Tray 1: 250 x A4 / 125 x A3 sheets (80gsm) Tray 2: 3,000 x A4 / 1,500 x A3 sheets (80gsm)
Stapling	Stapling	50 x A4 sheets / 30 x A3 sheets (80gsm)
	Paper Weight	64 to 105gsm; 2 x 106 to 209gsm cover pages
	Staple-2400	3 x 5,000 staples cartridges per box (44954102)
Saddle-Stitch	Stapling	Up to 15 sheets (80gsm)
	Paper Weight	64 to 105gsm; 1 x 106 to 209gsm cover pages
	Paper Capacity	Tray 3: 25 booklets (5 sheets per book, folded)
	Staple-3100	4 x 2,000 staples cartridges per box (44954103)
Hole Punch (Option)	Versions	2 hole and 4 hole units available
	Paper Weight	52 to 209gsm
	Hole Diameter	6.5mm
	Hole Position	80 mm apart



Saddle-Stitch Finisher
ES9465/75 MFP: 45587101

Stacking	Paper Size	A5-R to A3
	Paper Weight	52 to 280gsm
	Paper Capacity	Tray 1: 250 x A4 / 125 x A3 sheets (80gsm) Tray 2: 2,000 x A4 / 1,000 x A3 sheets (80gsm)
Stapling	Stapling	50 x A4 sheets or 30 x A3 sheets (80gsm)
	Paper Weight	64 to 105gsm; 2 x 106 to 209gsm cover pages
	Staple-2400	3 x 5,000 staples cartridges per box (44954102)
Hole Punch (Option)	Versions	2 hole and 4 hole units available
	Paper Weight	52 to 209gsm
	Hole Diameter	6.5mm
	Hole Position	80 mm apart



Multi-Staple Finisher
ES9465/75 MFP: 45587301

OKI EUROPE LTD.
Blays House, Wick Road
Egham, TW20 0HJ
United Kingdom
T +44(0) 20 8219 2190
F +44(0) 20 8219 2199
WWW.OKIEXECUTIVESERIES.COM

OKI
Open up your dreams