

B6250/B6500

OKI
PRINTING SOLUTIONS



User's Guide

B6250/B6500



PREFACE

Every effort has been made to ensure that the information in this document is complete, accurate, and up-to-date. The manufacturer assumes no responsibility for the results of errors beyond its control. The manufacturer also cannot guarantee that changes in software and equipment made by other manufacturers and referred to in this guide will not affect the applicability of the information in it. Mention of software products manufactured by other companies does not necessarily constitute endorsement by the manufacturer .

While all reasonable efforts have been made to make this document as accurate and helpful as possible, we make no warranty of any kind, expressed or implied, as to the accuracy or completeness of the information contained herein.

The most up-to-date drivers and manuals are available from the Oki web site:

<http://www.okiprintingsolutions.com>

Copyright © 2009 Oki Printing Solutions

Oki, Oki Printing Solutions and Microline are registered trademarks of Oki Electric Industry Company, Ltd.

Microsoft, MS-DOS and Windows are registered trademarks of Microsoft Corporation.

Other product names and brand names are registered trademarks or trademarks of their proprietors.

Printer Model No: B6500: JEB-6, B6250: JEB-2



Achieves ENERGY STAR energy savings; product fully qualifies when packaged with (or used with) a duplex unit.



This product complies with the requirements of the Council Directives 89/336/EEC (EMC), 73/23/EEC (LVD) and 1999/5/EC (R&TTE) as amended where applicable on the approximation of the laws of the member states relating to electromagnetic compatibility, low voltage and radio & telecommunications terminal equipment.

IMPORTER TO THE EU

Oki Europe Limited (trading as OKI Printing Solutions)
Blays House
Wick Road
Egham, Surrey
TW20 0HJ
United Kingdom

For all sales, support and general enquiries contact your local distributor.

ENVIRONMENTAL INFORMATION



CONTENTS

Preface	2
Notes, cautions and warnings.	5
Basic Operations	6
Main Components and Their Functions	6
Standard Configuration	6
With Optional Accessories	7
Internal View	8
Control Panel	9
Display	10
Print Screen	10
Menu Screen	10
Switching On and Off the Power	11
Switching On the Power	11
Switching Off the Power	11
Power Save Modes	12
Exiting the Power Save Mode	12
Cancelling/Checking Printing	13
Cancelling Printing	13
Checking Status of Print Data	13
Displaying Optional Accessory Configuration and Paper Tray Settings	14
Printing	15
Printing From the Computer	15
Useful Print Features In Properties Dialog Box	15
Printing on Envelopes	16
Loading Envelopes	16
Printing on Envelopes	17
Printing on Transparencies	18
Loading Transparencies	18
Printing on Transparencies	18
Printing on Custom Size Paper/Long Paper	19
Loading Custom Size Paper	19
Setting Custom Paper Sizes	20
Printing on Custom Size Paper	21
Special Printing Features	22
Print Confidential Document - Secure Print	22
Stored Job	22
Proof Print - Print After Checking Printing Result	22
Print at a Specified Time - Timed Job	22

Direct Printing of PDF Files	23
Printing via Electronic Mail - E-mail Printing.	23
Barcode Printing.	24
Loading Paper	25
Settings on the Control Panel	27
About this Chapter	27
Control Panel Features	27
LCD Display	28
Navigating the Control Panel Menus	28
Changing the Display and Reporting Language.	29
Troubleshooting	30
When Paper Jams	30
Inside Cover A	30
Inside Paper Tray	31
Inside Cover B	32
Inside Cover C (Duplex Unit)	32
Inside Cover D (Offset Catch Trays)	32
When Problems Occur	33
When the Print Quality is Poor	38
Network Related Troubles	40
Using TCP/IP	40
Daily Care	41
Drum/Toner Cartridge Replacement	41
Caution on Handling the Drum/Toner Cartridge . . .	41
Replacing the Drum/Toner Cartridge	42
Cleaning the Printer	44
Cleaning the Exterior	44
Cleaning the Interior.	45
Cleaning the Feed Rolls.	46
When Moving the Printer	49
Index.	51
Oki contact details	53

NOTES, CAUTIONS AND WARNINGS

NOTE

A note provides additional information to supplement the main text.

CAUTION!

A caution provides additional information which, if ignored, may result in equipment malfunction or damage.

WARNING!

A warning provides additional information which, if ignored, may result in a risk of personal injury.

For the protection of your product, and in order to ensure that you benefit from its full functionality, this model has been designed to operate only with genuine OKI Printing Solutions print (toner/drum) cartridges. These can be identified by the OKI Printing Solutions trademark. Any other print cartridge may not operate at all, even if it is described as "compatible", and if it does work, your product's performance and print quality may be degraded.

Specifications subject to change without notice. All trademarks acknowledged.

BASIC OPERATIONS

MAIN COMPONENTS AND THEIR FUNCTIONS

STANDARD CONFIGURATION

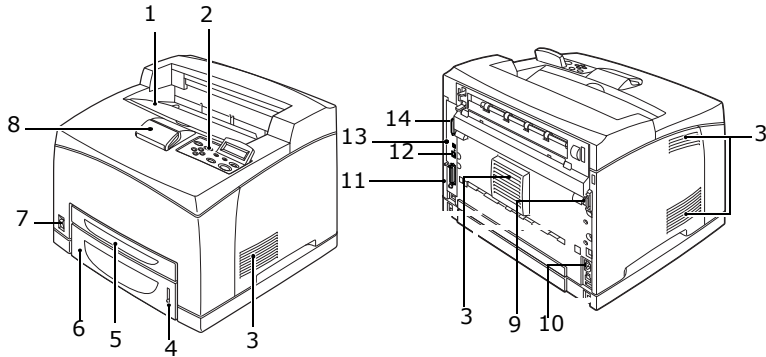

NO.	NAME	DESCRIPTION
1	Centre output tray	Print jobs are output here with the printed side facing down.
2	Control panel	Consists of the essential operation buttons, indicators and display.
3	Ventilation hole	Releases heat to prevent the interior of the printer from heating up.
4	Paper meter	A meter to check the amount of remaining paper. Attached to the 550 tray.
5	Tray 1	Sets the 150 tray.
6	Tray 2	Sets the 550 tray.
7	Power switch	Switches the power of the printer on and off. Pressing the switch to the < > position switches it on and pressing it to the <0> position switches it off.
8	Paper stopper	Raise this when printing on paper larger than Letter/ A4 size.
9	Duplex unit connector	For connecting the optional duplex unit.

NO.	NAME	DESCRIPTION
10	Power cord cable connector	For connecting the power cord cable.
11	Parallel connector	For connecting the parallel cable.
12	Network connector	For connecting the network cable when connecting this printer to the network for use.
13	USB connector	For connecting the USB cable.
14	Serial connector	For connecting the serial cable.

WITH OPTIONAL ACCESSORIES

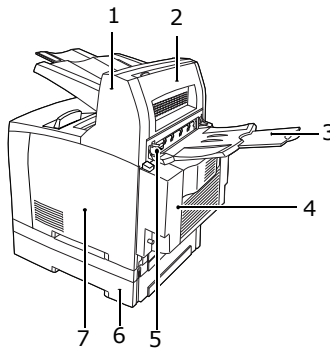

NO.	NAME	DESCRIPTION
1	Offset catch tray (optional)	Allows you to stagger the output position for each print job (offset output).
2	Cover D (optional)	Open this when paper is jammed inside the offset catch tray.
3	Rear tray (optional)	Use this tray if you want to reduce curling of paper when printing heavyweight paper. Print jobs are output here with the printed side facing up.
4	Duplex unit (Cover C)	Enables 2 sided printing. When paper is jammed inside the duplex unit, it is described as cover C.

NO.	NAME	DESCRIPTION
5	Rear output tray lever	When the rear tray has been installed, the paper output location can be switched between it and the centre output tray. Raise the lever to output to the rear tray and lower the lever to output to the centre output tray.
6	A4 universal tray	Can install up to two levels of an Letter/A4 universal tray (550) to this printer.
7	Right detachable cover	Remove this when installing optional accessories such as hard disk and additional memory.

INTERNAL VIEW

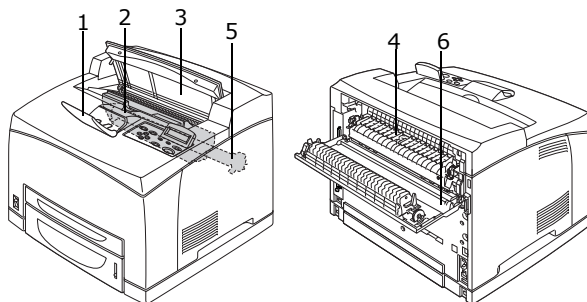

NO.	NAME	DESCRIPTION
1	Paper stopper	Raise this when printing on paper larger than A4 size.
2	Drum/toner cartridge	Contains the toner and the photosensitive drum.
3	Cover A	Open this when replacing the drum/toner cartridge and removing jammed paper.
4	Fuser unit	Fixes the toner on the paper. Do not touch this when using the printer as it is hot.
5	Transfer roll cartridge	Transfers the toner image on the surface of the photosensitive drum to the paper.
6	Cover B	Open this when removing jammed paper.

CONTROL PANEL

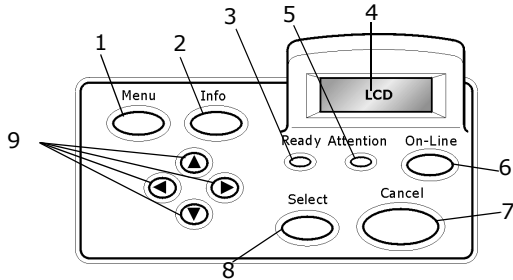

NO.	NAME	DESCRIPTION
1	<MENU> button	Press to move to menu operation.
2	<INFO> button	Press to print the menu map. The menu map (2 pages) will print with all the current printer settings.
3	<READY> indicator	When the light is on, the printer is ready to receive data from the computer.
4	LCD display	Displays the setting items, machine status, and messages.
5	<ATTENTION> indicator	When the light is on, there is a malfunction in the printer.
6	<On-Line> button	Press to enter the off-line status. When in the off-line status, the machine cannot receive data or process printing. Press again to exit the off-line status and enter the on-line status (where the machine can receive data from the computer).
7	<CANCEL> button	Press to cancel printing. Press to exit Menu Mode.
8	<Select> button	Press to select the currently displayed menu on setting.
9	<▲> <▼> <◀> <▶> buttons	Press these to move to the required menu, item and candidate value on the display.

DISPLAY

There are two types of screens shown: Print screen (for displaying printer status) and Menu screen (for setting configuration).

NOTE

The message displayed differs according to the options installed and setting status.

PRINT SCREEN

The Print screen appears when the machine is printing or waiting for data. The following contents are shown on the screen.

Current printer status—Shown at top left, e.g. Online (ready to print), printing, etc.

Port receiving data—Shown at bottom left. Which printer port is currently receiving print data, e.g. USB, Net, etc.

Emulation—Shown at bottom right. Which page description language emulation is currently in use, e.g. PCL, PS, etc.

MENU SCREEN

Screen for configuring settings related to the printer.

This screen appears when you press the <Menu> button. The first of a list of menus appears at top right. Further depressions of the <Menu> button or the <▲> <▼> buttons cycle through the available printers menus.

Refer to:

- > Items that can be set on the Menu screen: "Settings on the Control Panel" on page 28.

SWITCHING ON AND OFF THE POWER

SWITCHING ON THE POWER

1. Press the power switch of the printer to the <|> position.
2. When the power is switched on, various screens will be displayed on the control panel. Check that this display changes to "Online".

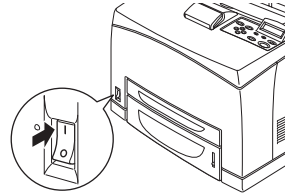

NOTE

When "Please wait..." is displayed, the printer is in the process of warming up. Printing is unavailable during this period. When the printer is ready for printing, "Online" will be displayed.

Important:

- > If error message is displayed, refer to the Message List in the Reference Guide for guidance on how to fix it.

SWITCHING OFF THE POWER

Important:

- > Do not switch off the printer power when printing is in progress. It may lead to a paper jam.
 - > Once the power is switched off, print data remaining in this printer or information saved in the memory of this printer will be deleted.
1. By checking the display on the control panel, confirm that the printer is not processing any data.
 2. Press the power switch to the <O> position to switch the power off.

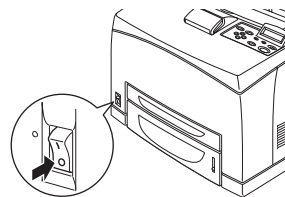

POWER SAVE MODES

This printer is equipped with a Power Save mode to reduce power consumption when it is left idle. The default idle time from last print activity until the printer enters Power Save mode is 5 minutes. This time can be adjusted by the operator to any of the following: 5, 15, 30, 60 or 120 minutes.

When no print data is received within 5 minutes (default) since the last page is printed, the printer will enter Power Save mode. An informative message is displayed on the operator panel indicating Power Save Mode. Consumption of power during Power Save mode is 10 Watts or less, and the time required to exit from Power Save mode to a print-ready status is about 10 seconds.

EXITING THE POWER SAVE MODE

The printer automatically exits from Power Save mode once it receives data from the computer or if any key on the operator panel is pressed.

CANCELLING/CHECKING PRINTING

CANCELLING PRINTING

To cancel printing, you can either cancel the print job at this printer or at the computer.

Canceling a Print Job at the Printer

Press the <CANCEL> button then press the <ON-LINE> button on the control panel. However, pages being printed at the moment will continue to be printed.

Canceling Print Jobs at the Computer

Double-click the printer icon  at the bottom right of the taskbar in Windows.

From the displayed window, click the document name that you wish to delete and press the <Delete> key.

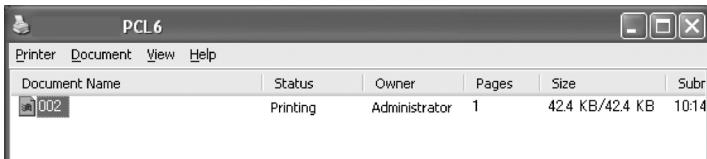

CHECKING STATUS OF PRINT DATA

Checking in Windows

Double-click the printer icon  on the task bar at the bottom right of the screen.

From the displayed window, check the column, [Status].

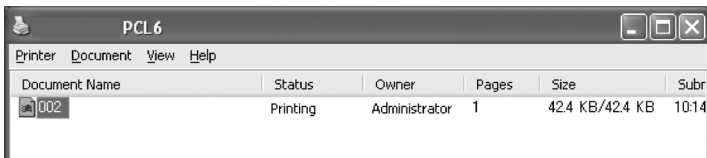

DISPLAYING OPTIONAL ACCESSORY CONFIGURATION AND PAPER TRAY SETTINGS

When using this printer as a network printer and with SNMP protocol enabled, you can display on the printer driver, the optional accessory configuration and settings configured at the control panel such as paper type or size. These settings are displayed on the [Options] tab. This section explains the procedure using Windows XP as an example.

Important:

- > When using USB or Parallel connection to this printer, this feature cannot be used. You have to manually set the items on the printer driver.
- > The rear tray information cannot be obtained. You have to manually set the item.
- > For paper size and paper type settings, you must configure them at the control panel beforehand. Even if you change the settings here, they will not be reflected on the printer itself.

NOTE

- > *When using this feature, you have to activate the SNMP port (default: [Enable]) on the printer using the control panel.*
 - > *For Windows NT 4. 0/Windows 2000/Windows XP, only users with administrator's rights can change the settings. Users without administrator's rights can only check the contents.*
1. From the [Start] menu, click [Printers and Faxes] and then display the properties of the printer to be used.
 2. Click the [Device Options] tab.
 3. Click [Get Information from Printer].

NOTE

- The properties of the printer can be displayed on the printer driver.*
4. Click [OK]. The contents of the [Device Options] tab will be updated based on the data obtained from the printer.

PRINTING

PRINTING FROM THE COMPUTER

This section explains the basic flow when printing from application software in a Windows® environment.

(The procedure may differ according to the computer or system configuration used.)

Important:

- > Do not switch off the power to the printer when printing is in progress. It may lead to a paper jam.

NOTE

- > *This section explains printing with the PCL driver as an example.*

1. From the [File] menu of the application software, select [Print].
2. Select this printer as the printer to be used to start printing. To use the various print features of this printer, display the printer properties dialog box to set the necessary items. For details on each item and how to set them, refer to the Online Help for the printer driver.

Important:

- > If the paper tray information is not correct, change the settings on the [Set Up] tab of the printer driver before continuing. For details on how to do the settings, refer to the Online Help for the printer driver.

USEFUL PRINT FEATURES IN PROPERTIES DIALOG BOX

- > The following selections are available in the [Setup] tab: Paper Size, Media Type, Paper Source, Paper Destination Paper Feed Options*, Finishing Mode**, and 2-sided Printing.

*Paper Feed Options include: Auto Resize, Covers, Auto Tray Change, Media Check, and Skip Blank Pages, Tray 1 Settings, and Media Type.

**Finishing Mode includes: Standard, 2-up, 4-up, 6-up, 8-up, 9-up, 16-up, PosterPrint, and Booklet.

NOTE

- > You can set the print features in the properties dialog box from the printer icon by selecting [Printers and Faxes] (or [Settings] > [Printers] depending on the OS).

PRINTING ON ENVELOPES

For details on the envelopes that can be used, refer to “Usable Paper” in the Reference Guide. The procedure to print on envelopes is as follows.

LOADING ENVELOPES

You have to close the flaps of the envelopes and load them with the address side facing up in the orientation shown in the diagram below.

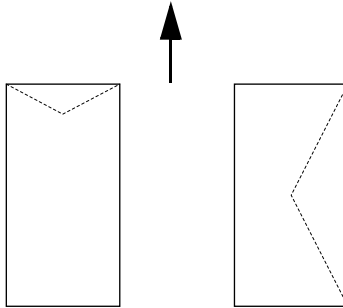

Envelopes should be loaded with the flap side down and to be fed into the printer in the direction indicated by the arrow.

The following explains how to load the envelopes, using COM-10 envelopes as an example, in trays 1 to 4.

Important:

- > The reverse side of the envelope cannot be printed on.

NOTE

- > For details on the procedure to load paper in a paper tray, refer to “Loading Paper” on page 26.

1. Load the envelopes in the portrait orientation so that the flaps are turned to the right side.
2. Slide the length guide and right width guide to the size of the loaded envelopes.
3. On the control panel, change the paper type to [Envelope]. For details, refer to "Setting Paper Types" in the Reference Guide.
4. On the control panel, change the paper size of the tray to [COM-10 Envelope]. For details, refer to "Setting Custom Paper Sizes" in the Reference Guide.

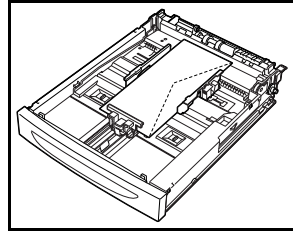

PRINTING ON ENVELOPES

To print on envelopes, display the [Tray/Output] tab and [Basic] tab. This section explains the procedure using WordPad on Windows XP as an example.

NOTE

> *The way to display the printer properties dialog box differs according to the application software. Refer to the manual of each application software.*

1. From the [File] menu, select [Print].
2. Select this printer from the drop down list and click [Properties].
3. Click the [Setup] tab.
4. Select the loaded paper tray from [Source] or click the [Media Type] and then select [Com10].
5. Click [OK].
6. Click [Print] in the [Print] dialog box to start printing.

PRINTING ON TRANSPARENCIES

LOADING TRANSPARENCIES

Load transparencies in trays 1 to 4.

Important

- > Transparencies with white frames or full-colour transparencies cannot be used.

The way to load transparencies in the paper tray is the same as the way to load standard size paper. For details, refer to "Loading Paper" (P. 26).

You must also set paper type for the paper tray to [Transparency] on the control panel.

Refer to "Setting Paper Types" in the Reference Guide to change the setting.

PRINTING ON TRANSPARENCIES

To print on transparencies, click on [Properties] from the [File] [Print] menu, click the [Setup] tab. This section explains the procedure using WordPad on Windows XP as an example.

NOTE

- > *The way to display the printer properties dialog box differs according to the application software. Refer to the manual of your respective application software.*
- > *Printing transparencies continuously may lead to the output transparencies sticking to each other. As a guide, remove the transparencies from the output tray after about 20 sheets and then fan them to lower their temperatures.*

1. From the [File] menu, select [Print].
2. Select this printer as the printer to be used and click [Preferences].
3. Click the Media Type drop down box and click on transparencies.
4. Select the loaded paper tray from Source Drop down and click on the tray that contains the transparencies.
5. Click the Paper Size drop down.

6. From [Paper Size], select the size of the original document.
7. Click [OK].
8. Click [Print] in the [Print] dialog box to start printing.

PRINTING ON CUSTOM SIZE PAPER/LONG PAPER

This section explains how to print on custom size paper such as long paper.

The paper sizes that can be set on this printer are as follows:

	LONG EDGE	SHORT EDGE	REMARKS
Tray 1	127–900mm (5"–35.4")	76–216mm (3"–8.5")	To load long-size paper with the long edge exceeding 356mm, load the paper with the edge protruding from the tray.
Trays 2–4	148–356mm (5.8"–14")	98–216mm (3.9–8.5")	

LOADING CUSTOM SIZE PAPER

The way to load custom size paper with the long edge shorter than 356 mm in trays 1 to 4 is the same as loading standard size paper. For details, refer to "Loading Paper" (P. 26).

To load long paper in tray 1, follow the procedure below:

1. Pull the paper tray out to its maximum.

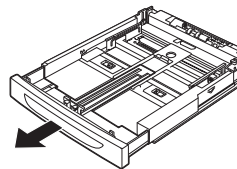

NOTE

> Pull the extendable part out to its maximum. For details on the procedure to extend the paper tray, refer to "Loading Paper" (P. 26).

2. Load the paper with the side to be printed facing up. Curl up the back end of the paper so that it will not fall from the tray.
3. Push the paper tray completely into the printer.

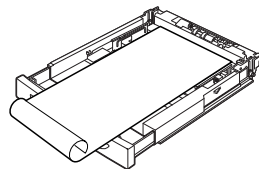

SETTING CUSTOM PAPER SIZES

Before printing, set the custom size on the printer driver.

You have to configure the settings on the control panel too when loading custom size paper in trays 1 to 4 for printing. For details on setting the control panel, refer to "Setting Custom Paper Sizes" in the Reference Guide.

CAUTION!

When setting the paper size on the printer driver and the control panel, specify the size of the actual paper used. Setting the wrong size for printing will cause jam detection. This is especially true if you configure a bigger size when using a narrow width paper.

On the printer driver, set the custom size in the [Paper Size] dialog box. This section explains the procedure using Windows XP as an example.

NOTE

For Windows NT 4.0/Windows 2000/Windows XP, only users with administrator's rights can change the settings. Users without the rights can only check the contents.

1. From the [File] menu, click [Print].
2. Select [Properties] then select the [Setup] tab.
3. Select Option as needed: Source, Media Type, etc.
4. You may select a previously stored custom size from the list or you may add an additional custom size.
5. To add a new custom size:
 - A. Select paper feed options.
 - B. Select Custom Size.
 - C. In the Name Field, Type a name for your custom size.
 - D. Click on the Unit of measure radio button for the units you would like to use (mm for millimetres or inch for inches.)
 - E. In the Width field, enter the width of the custom size paper.

- F. In the Length field, enter the length of the custom size paper.
- G. Click add to store the new custom size.
- H. Click OK to close the Dialog Box.

NOTE

- > *You may use the Modify selection to change a previously stored custom size.*
- > *You may use the Delete Selection to delete a previously stored custom size.*

PRINTING ON CUSTOM SIZE PAPER

The procedure to print on custom size paper is as follows.

This section explains the procedure using WordPad on Windows XP as an example.

NOTE

The way to display the printer properties dialog box differs according to the application software. Refer to the manual of your respective application software.

1. From the [File] menu, select [Print].
2. Select this printer as the printer to be used and click [Preferences].
3. Click the [Setup] tab.
4. Select the appropriate tray from [Source].
5. From [Paper Size], select the size of the original document.
6. From [Media Types], select the registered custom size, and then click [OK].
7. Click [Print] in the [Print] dialog box to start printing.

SPECIAL PRINTING FEATURES

Use of these features requires the optional hard disk or compact flash to be installed in the printer.

Detailed instructions on how to use these features are contained in the User Reference Guide.

IMPORTANT:

- > The hard disk may be damaged and erase important data saved in the hard disk. We recommend you back up your data.

PRINT CONFIDENTIAL DOCUMENT - SECURE PRINT

Secure Print is a feature that allows you to attach a password to a print job on the computer, send it to the printer for temporary storage, and then print the job from the printer control panel. When the printing of a Secure Print job is complete, the job is automatically deleted.

STORED JOB

A stored job is the same as a secure print job except that it is not deleted from the storage device after it is printed unless you specifically ask for this at the printer control panel. By storing frequently-used data in the printer, you can print the job from the printer control panel, without sending it from the computer again and again.

PROOF PRINT - PRINT AFTER CHECKING PRINTING RESULT

Proof Print is a feature that allows you to store the print data of multiple copies in the hard disk or compact flash, print out only the first set to check the print result and if satisfactory, print the remaining copies from the control panel.

PRINT AT A SPECIFIED TIME - TIMED JOB

The delayed print feature allows you to store the data in the printer beforehand and then print it out automatically at the specified time.

DIRECT PRINTING OF PDF FILES

You can send a PDF file directly to the printer for printing without using the printer driver. As the print data is sent directly to the printer, the printing process is simpler than printing with the printer driver and it is done at a faster speed. The way to print a PDF file directly is as follows.

Using PostScript Feature

You can use the PostScript feature to send a PDF file to the printer directly for printing.

PDF Files That Can Be Printed

PDF files that can be printed are those created by Adobe Acrobat 4 and Adobe Acrobat 5 (except one part of the features added by PS 1.4).

NOTE

- > You may not be able to print some PDF files directly by the printer due to the way they were created. When this happens, open the PDF files and use the printer driver to print them.*

PRINTING VIA ELECTRONIC MAIL - E-MAIL PRINTING

When the optional hard disk or compact flash has been installed and the printer is connected to a network, enabling it to receive e-mails via TCP/IP communication, e-mails can be sent from the computer to this printer.

Printing of e-mail contents and TIFF or PDF attachments can be done from this printer.

This feature may need to be enabled via the webpage under Networking/Receive Settings.

BARCODE PRINTING

This printer uses standard PCL font selection commands to enable printing of algorithm generated bar codes.

Benefits:

- > Any size barcode generation
- > Automatically generates checksums
- > Automatically adds stop and start characters

Intelligent barcoding

Unlike some barcode solutions, which merely add fonts to a PC or printer, this printer actually extends the PCL5 language. Barcode formatting, error detection and checksum calculation are performed by the printer, reducing the load on the host and the network. Barcodes can be printed in almost any size or rotation, bar width and height. Caption text can be embedded in the bars or printed above or below the bars in a variety of fonts and sizes.

NOTE

See the Reference Guide for detailed use information.

LOADING PAPER

1. Place the paper tray on a flat surface and remove the lid (if installed).

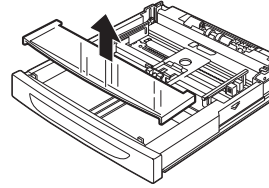

2. If the base plate of the paper tray is raised, push it down.

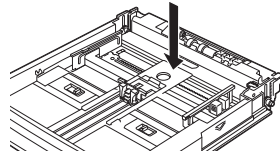

3. When loading paper longer than A4 size, slide the left and right lock tabs in the paper tray outwards to unlock them.

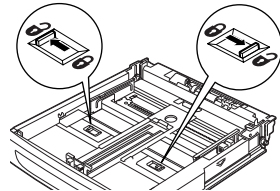

4. Hold the grip of the paper tray and pull its extendable part to the front until it reaches its maximum.

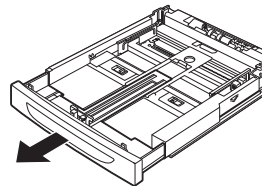

5. Squeeze the length guide and slide it to the desired paper size (1). Squeeze the right width guide and slide it to the desired paper size (2).

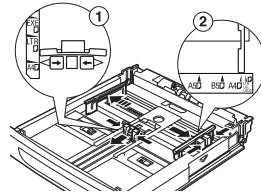

6. Load the paper with the side to be printed facing up and with all four corners aligned.

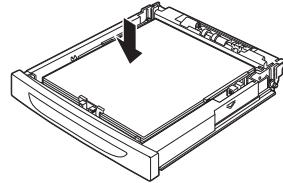

7. Close the lid of the paper tray and push the tray completely into the printer.

CAUTION!

Do not place paper over the right width guide.

Do not load paper exceeding the maximum fill line or the maximum capacity allowed.

Align the right width guide with the paper width correctly. If the right width guide is not in place, the paper will not be properly fed and this may cause paper jams.

The lid of the tray must be firmly closed. If not, the paper might become misaligned.

8. Depending on the types and sizes of the loaded paper, you need to configure settings on the control panel. Change the paper type when non-plain paper such as recycled paper, heavyweight paper or transparencies are loaded. Configure the paper size when custom size paper is loaded.

SETTINGS ON THE CONTROL PANEL

ABOUT THIS CHAPTER

This chapter introduces the control panel and its functions, and also demonstrates how to navigate through the control panel menus and submenus that allow you to view and change the printer settings.

Full details of the menu system are given in the Reference Guide. You can print a menu map showing all current printer settings by pressing the **Info** button on the control panel.

CONTROL PANEL FEATURES

The control panel is located on the front of the printer and contains the display (LCD), indicators and push buttons that allow you to view and change the printer settings.

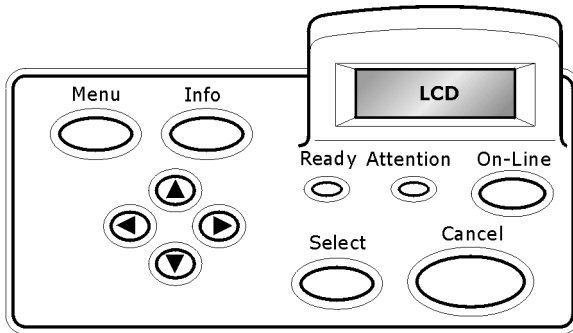

NAME	DESCRIPTION
<Menu> button	Press to move to the menu operation. Once in the menu operation, repeatedly pressing the menu button moves down the menu list.
<Info> button	Press to print the menu map. The menu map (2 pages) will print with all the current printer settings.
<Ready> indicator	When the light is on, the printer is ready to receive data from the computer.

NAME	DESCRIPTION
LCD display	Displays the setting items, machine status, and messages.
<Attention> indicator	When the light is on, there is a malfunction in the printer.
<On-Line> button/indicator	Press to enter the off-line status. When in the off-line status, the machine cannot receive data or process printing. Press again to exit the off-line status and enter the on-line status (where the machine can receive data from the computer).
<Cancel> button	Press to cancel printing. Press to exit the menu mode.
<Select> button	Press to activate the displayed setting. When you are changing the candidate values, pressing the Select button runs the currently displayed activity or saves the currently displayed candidate.
<▲> <▼> <◀> <▶> buttons	Press these to move to the required menu, item and candidate value on the display.

LCD DISPLAY

The LCD display shows status and error messages that inform you of the current status of the printer, and also displays menus, submenus and printer settings when you are in the menu system.

NAVIGATING THE CONTROL PANEL MENUS

When you press the **Menu** button on the control panel, you enter the printer's menu system. At that point, the first line of the display lists the active menu. You can change the active menu by pressing the <▲> or <▼> button or by pressing the **Menu** button.

To move to a sub-menu or to the available settings for the item selected press the <▶> button.

To cycle through the available settings for the currently selected item use the <▲> and <▼> buttons, then press the **Select** button to choose the setting you want.

To move back up a menu level and ultimately to exit the menu system press the **Cancel** button.

CHANGING THE DISPLAY AND REPORTING LANGUAGE

The default language for display messages and printed reports is English. You can change this to a different language as follows.

1. Press the **MENU** button on the control panel.
2. Press the <▼> button repeatedly to display the "**System Configuration Menu**".
3. Press the <▶> button to enter the "**System Configuration Menu**".
4. Press the <▼> button repeatedly to display the "**Language**" sub-menu.
5. Press the <▶> button to display the current language.
6. Press the <▲> or <▼> button repeatedly until the language you want is displayed.
7. Press the **Select** button to choose your preferred language, then press the **Cancel** button to exit the menu system.

TROUBLESHOOTING

WHEN PAPER JAMS

CAUTION!

When removing jammed paper, make sure that no pieces of torn paper are left in the machine. If a sheet of paper is wrapped around the heat roller, or when clearing a jammed paper that is difficult or impossible to see, do not try to remove it by yourself. Doing so can cause injuries or burns. Switch off the machine immediately, and contact your dealer or service.

Following the message on the control panel, open the cover and remove the jammed paper. If paper is torn, check for any remaining torn pieces of paper.

INSIDE COVER A

When the optional offset catch tray is installed, fold the tray first before opening cover A.

Open Cover A when a message to remove the drum/toner cartridge is displayed.

1. Open cover A (1), and holding the drum/toner cartridge by the grip, remove it from the printer (1).
2. Turn the roll as shown and remove any jammed paper inside (2).
3. Return the drum/toner cartridge and cover A to their original positions.

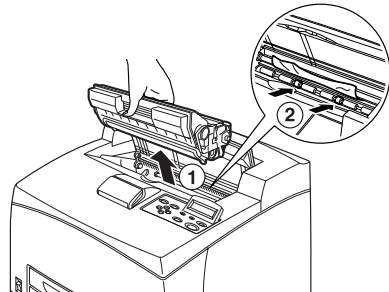

NOTE

- > When the optional offset catch tray is installed, close cover A first before returning the tray to its original position.
- > If you continue to print with the offset catch tray folded, this may cause a paper jam. Always use the printer with the tray open.

INSIDE PAPER TRAY

Pulling out paper trays

1. Pull out all paper trays and remove any wrinkled paper.
2. Examine the inside of the printer and remove any jammed paper.

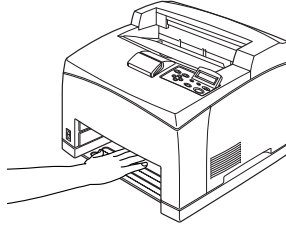

After removing paper,

1. Push the paper trays completely back into the printer.
2. Open and close cover A. Doing this will clear the error message.

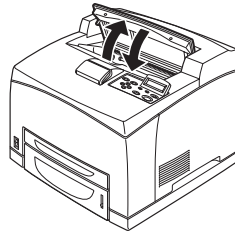

INSIDE COVER B

Remove the rear tray when opening the back cover.

Raise the lever as shown in the diagram and open the cover B (1). After opening cover B, open the cover of the fuser unit (2) and remove any jammed paper.

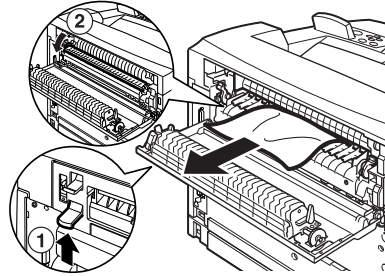

CAUTION!

The fuser unit is hot. You may get burned if you touch it directly.

INSIDE COVER C (DUPLEX UNIT)

Remove the rear tray when opening the back cover.

Push up the lever shown in the diagram to open the cover.

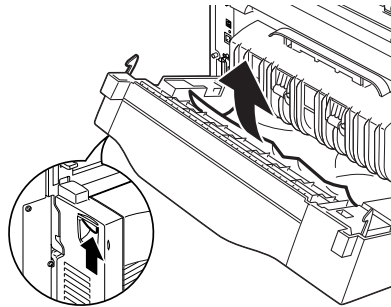

INSIDE COVER D (OFFSET CATCH TRAYS)

Open the cover and remove paper as shown.

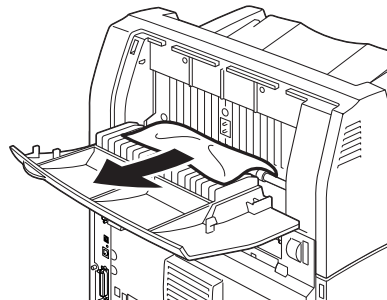

WHEN PROBLEMS OCCUR

Before treating the problem as a machine breakdown, refer to the following table and check the printer condition again.

WARNING!

- > **Never open or remove machine covers that are secured with screws unless specifically instructed in the user guide. A high voltage component can cause electric shock.**
- > **Do not try to alter the machine configuration, or modify any parts. An unauthorized modification can cause smoke or fire.**

NOTE

- > *Information on incorrect print processing will be stored in the [Error Log]. When no print processing is carried out, print the [Error Log] and check the print status. Print data that cannot be correctly processed may be discarded. Refer to the Information Menu in the Reference Guide for instructions on how to print the [Error Log].*
- > *Limitations of the printer and incorrect settings at the printer, computer and server corresponding to your network environment may also result in printing problems.*

SYMPTOM	REASON/ACTION
No power.	Is the power of the printer switched off? Push the power switch to the < > position to switch on the power.
	Is the power cord disconnected or not securely connected? Switch off the power of the printer and connect the power cord to the power outlet again. Then, switch on the power to the printer.
	Is the power cord connected to a power outlet with the correct voltage? Connect the printer exclusively to a power outlet with a suitable voltage and current rating.

SYMPTOM	REASON/ACTION
Cannot print.	Is the light of the <READY> indicator off? If so, the printer is off-line or in menu setting mode. Press the <ON LINE> button to return the printer to its on-line status.
	Is there a message displayed on the control panel? Follow the message to rectify the problem. A list of messages and guidance on how to deal with them is given in the Reference Guide.
	When a parallel cable is used for connection, are you using a computer that supports bi-directional communication? See instructions on the Parallel Menu in the Reference Guide.
	If the printer has insufficient memory, use one of the following methods to rectify the problem. When the printer driver is set to [1200dpi] on the [Graphics] tab, set it to [600dpi]. Install the additional memory (optional) to increase the memory. Reduce the complexity of the print job. See [Print Mode] / [Page Print Mode] in the Online Help for the printer driver.
Print job sent but the light of the <READY> indicator is not blinking or on.	Is the interface cable disconnected? Switch off the power and check the connection of the interface cable.
	Is the interface configured? Check the port status of the interface.
	Is the computer environment correctly set up? Check the computer environment, such as the printer driver.
Light of <ATTENTION> indicator is on.	Is there an error message displayed on the control panel? Check the displayed message and rectify the error. A list of messages and guidance on how to deal with them is given in the Reference Guide.
Light of <ATTENTION> indicator is blinking.	An error that you cannot rectify yourself has occurred. Record the displayed error message or error code, switch off the power, pull out the power plug from the outlet, and then contact service.
Although no print job is sent, the message "Printing" is displayed on the control panel (when using the parallel interface).	Did you switch on the power of the computer after switching on the power to the printer? Pressing the <Cancel> button cancels the printing. Check that you switch on the power of the computer when switching on the power to the printer.

SYMPTOM	REASON/ACTION
Poor print quality.	There may be a problem with the image. Refer to the section after this, "When the Print Quality is Poor" to rectify the problem. " When the Print Quality is Poor" (P. 39)
The correct characters are not printed (printing garbage).	The printer is printing with non-standard built-in fonts. Check the fonts used in the application. Download the necessary fonts when using PostScript.
The printout is different from what is displayed on the screen.	Did you change the TrueType font settings to printer fonts? Change to TrueType font printing for [Font Substitution] on the [Setup] tab of the printer driver. Online Help for the printer driver
The light of the <READY> indicator is on and blinking but there is no print output.	There are jobs remaining in the printer. Cancel printing or force the remaining data to be printed. To forcibly print the job, press the <ON LINE> button to set the printer in off-line mode, then press the <FEED/SELECT> button. After the job has been printed, press the <ON LINE> button again to return the printer to online mode. When a parallel/USB port is used, data may be transmitted in the middle of a job depending on when the <ON LINE> button is pressed. In this case, subsequent print data received after the <FEED/SELECT> button is pressed, will be recognized as a new job. The data will be printed after the off-line mode has been cancelled. Furthermore, it may not be printed properly. Cancelling printing: " Cancelling/Checking Printing" (P. 14)
Printing is very slow.	The receive buffer is insufficient. When printing documents of high resolution, reduce the memory capacity of items not in use. It is recommended to disable ports not in use, and channel the memory to other purposes.
	Is the printer driver set to [1200dpi] on the [Graphics] tab? Changing the setting to [600dpi] will shorten the print time. For guidance refer to the online help in the printer driver.
	Printing with TrueType fonts may take up printing time. Change the printing method for TrueType fonts in [Specify Font] on the [Detailed Settings] tab of the printer driver. For guidance refer to the online help in the printer driver.
Top section of printed document is missing. Text is reduced.	Are the paper tray guides set in the correct positions? Set the length guide and the right width guide in the correct positions. See "Loading Paper" on page 26.

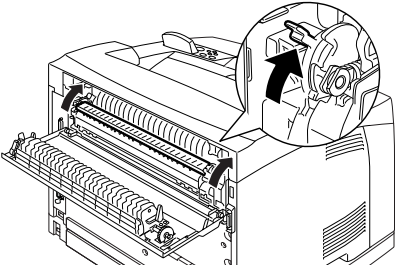
SYMPTOM	REASON/ACTION
<p>Paper cannot be fed. Paper jam. Multiple papers are fed. Papers are fed at an angle. Paper is wrinkled.</p>	<p>Is the paper correctly set? Load the paper correctly. For labels, transparencies or envelopes, fan them well first to allow air to enter between each sheet before loading. See "Loading Paper" on page 26.</p>
	<p>Is the paper damp? Replace with paper from a new ream. See "Loading Paper" on page 26.</p>
	<p>Is the correct type of paper used? Load the correct type of paper. See "Usable Paper" in the Reference Guide.</p>
	<p>Is the paper tray set correctly? Push the paper tray completely into the printer.</p>
	<p>Is the printer placed on a flat location? Place the printer on a flat stable surface.</p>
	<p>Are the paper tray guides set in the correct positions? Set the length guide and right width guide in the correct positions. See "Loading Paper" on page 26.</p>
	<p>Have you used any picture papers? Clean the feed roll. See "Cleaning the Feed Rolls" on page 47.</p>
	<p>Papers are fed in more than 1 sheet at a time. Fan the paper to be loaded and load again. Replenish paper only when the paper tray is empty.</p>
<p>Envelope is wrinkled.</p>	<p>Envelopes can get wrinkled depending on the type used. Open cover B of this printer and lift up the levers at both ends of the fuser unit. The wrinkles can be reduced.</p>  <p>After printing the envelope, remember to return the levers to their original positions.</p>

SYMPTOM	REASON/ACTION
Strange noise.	Is the printer placed on a flat location? Place the printer on a stable surface.
	Is cover A open? Close cover A securely.
	Is the paper tray set correctly? Push the paper tray completely into the printer.
	Are there foreign objects inside the printer? Switch off the power and remove any foreign objects inside the printer. If the object cannot be removed unless the printer is disassembled, contact service.

WHEN THE PRINT QUALITY IS POOR

When the print quality is poor, select the closest symptom from the following table to rectify the problem.

If the print quality does not improve after carrying out the appropriate action, contact service.

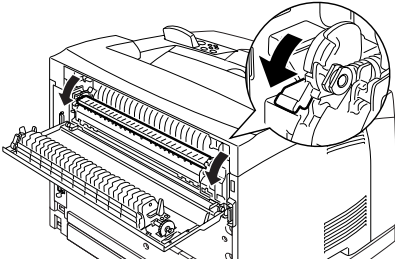
SYMPTOM	REASON/ACTION
Printing is light. (faded, blurred).	The paper is damp. Replace with paper from a new ream. " Loading Paper" (P. 26)
	The drum/toner cartridge is defective/damaged or there is no more toner inside the cartridge. Replace with a new drum/toner cartridge. " Drum/Toner Cartridge Replacement" (P. 42)
	The Toner Saving feature is on. Uncheck the [Toner Saving] checkbox on the [Graphics] tab of the printer driver. Online Help for the printer driver
	Levers on both sides of the fuser unit are raised. Open cover B of this printer and push down the levers at both ends of the fuser unit. 
Black spots or streaks are printed.	The drum/toner cartridge is defective or damaged. Replace with a new drum/toner cartridge. " Drum/Toner Cartridge Replacement" (P. 42)
Dirt appears at equal intervals.	The feed route of the paper is stained. Print a few pages to remove the stains.
	The drum/toner cartridge is defective or damaged. Replace with a new drum/toner cartridge. See "Drum/Toner Cartridge Replacement" on page 42.

SYMPTOM	REASON/ACTION
White dots appear in black filled areas.	The paper used is not suitable. Load the correct type of paper. See "Usable Paper" in the Reference Guide.
	The drum/toner cartridge is defective or damaged. Replace with a new drum/toner cartridge. See "Drum/Toner Cartridge Replacement" on page 42.
Printed image smudges when rubbed with your finger. The toner is not fixed on the paper. Paper is smeared with toner.	The paper loaded in the paper tray does not match the paper type set on the control panel. Set the appropriate paper type of the paper loaded in the paper tray on the control panel. See "Usable Paper" and "Setting Paper Types" in the Reference Guide.
	The paper is damp. Replace with paper from a new ream. See "Loading Paper" on page 26.
	The paper used is not suitable. Load the correct type of paper. See "Usable Paper" in the Reference guide.
The whole piece of paper is printed black.	The drum/toner cartridge is defective or damaged. Replace with a new drum/toner cartridge. See "Drum/Toner Cartridge Replacement" on page 42.
	This may be due to breakdown of high voltage power. Contact service.
Nothing is printed.	Multiple sheets of paper are fed simultaneously. Fan the paper well and reload. See "Loading Paper" on page 26.
	The drum/toner cartridge is defective/damaged or there is no more toner inside the cartridge. Replace with a new drum/toner cartridge. See "Drum/Toner Cartridge Replacement" on page 42.
Spots of missing text.	This may be due to breakdown of high voltage power. Contact service.
	The paper is damp. Replace with paper from a new ream. See "Loading Paper" on page 26.
	The paper used is not suitable. Load the correct type of paper. See "Usable Paper" in the Reference Guide.
Text is blurred.	The paper used is not suitable. Load the correct type of paper. See "Usable Paper" in the Reference Guide.
	The paper is damp. Replace with paper from a new ream. See "Loading Paper" on page 26.

SYMPTOM	REASON/ACTION
Missing characters throughout the length of the paper.	The drum/toner cartridge is defective/damaged or there is no more toner inside the cartridge. Replace with a new drum/toner cartridge. See "Drum/Toner Cartridge Replacement" on page 42.
Text or images are printed at an angle.	The paper tray guides are not set in the correct positions. Set the length guide and the right width guide in the correct positions. See "Loading Paper" on page 26.
Transparencies and envelopes are not printed clearly.	The type of transparency or envelope loaded cannot be used in this printer. Load the correct type of paper. See "Usable Paper" in the Reference Guide.
	Check that the paper type on the printer driver or the control panel is correctly set. See "Setting Paper Types" in the Reference Guide.
	The Draft Mode feature is turned on and the resolution is set at a low level on the printer driver. Change the settings on the [Detailed Settings] or [Graphics] tab of the printer driver.

NETWORK RELATED TROUBLES

USING TCP/IP

When a problem occurs in the TCP/IP environment refer to the Reference Guide.

DAILY CARE

DRUM/TONER CARTRIDGE REPLACEMENT

The drum/toner cartridge includes the toner and the photosensitive drum. A message will appear on the control panel when it is about time to replace the drum/toner cartridge. If the message indicates that the printer is still ready to print you should still be able to print about 200 pages before actually replacing the cartridge, otherwise you should replace it immediately.

The possible number of pages that can be printed differs according to factors such as the print contents, paper size, paper type, environment used, and the frequency of switching on/off the power of the machine.

If you continue to print with a drum/toner cartridge whose replacement is long overdue, it may affect the functions of this machine, such as the print quality. It is recommended to install a new drum/toner cartridge.

You can set whether to stop printing when the drum/toner cartridge is due for replacement.

WARNING!

Never expose a drum/toner cartridge to an open flame. It can cause an explosion and you can be burnt.

CAUTION ON HANDLING THE DRUM/TONER CARTRIDGE

When handling the drum/toner cartridge, take note of the following points:

- > Do not subject it to direct sunlight or strong light.
- > When installing the drum/toner cartridge, select a location not subject to strong light and try to finish the installation within 5 minutes.
- > Do not touch the surface of the photosensitive drum. Do not let the drum/toner cartridge stand or place it upside down. The drum might be damaged.
- > A drum shutter protects the photosensitive drum from light. Do not open the drum shutter.

- > Although the toner is not harmful to the body, wash it off immediately if your hands or clothes are stained with it.
- > It is recommended to use the drum/toner cartridge within 1 year after opening it.

REPLACING THE DRUM/TONER CARTRIDGE

1. Remove any output paper and open cover A.

NOTE

- > When the offset catch tray (optional) is installed, fold the tray first before opening cover A.
- > Do not touch any parts inside the printer.

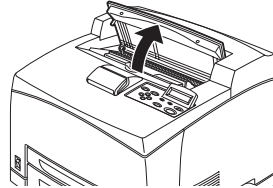

2. Hold the drum/toner cartridge by the grip and pull it out slowly.

NOTE

- > To prevent the toner from dirtying the floor, lay a piece of paper on the floor first before putting the drum/toner cartridge down.

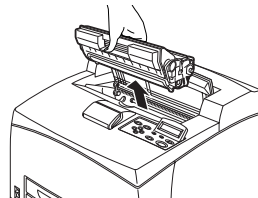

>

3. Take the new drum/toner cartridge out of the packaging box and shake it 7 to 8 times as shown in the diagram.

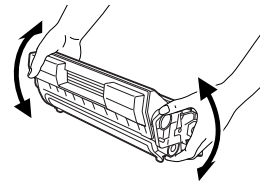

Important:

- > If the toner is not evenly spread out, the print quality may be reduced. Also, if you did not shake the drum/toner cartridge well, there may be operating noise or the interior of the cartridge may be damaged during operation.
- > Do not touch the surface of the photosensitive drum.

- 4.** Place the drum/toner cartridge on a flat surface and pull out the seal horizontally.

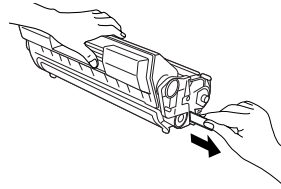

Important:

- > When pulling out the seal, pull it out horizontally. The tape might break if it is pulled out diagonally.
- > After the seal has been pulled out, do not shake or bump the drum/toner cartridge.

- 5.** Hold the drum/toner cartridge by the grip and insert it into the slot inside the printer.

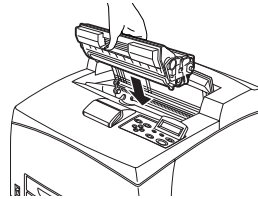

Important:

- > Do not touch any parts inside the printer.
- > Ensure that the drum/toner cartridge is firmly set.
- > After opening cover A, remove any dust or stains inside the printer with a dry clean cloth.

- 6.** Close cover A securely.

Important:

- > If the offset catch tray is folded as in step 1, close cover A and then return the tray to its original position.
- > If you continue to print with the offset catch tray folded, this may cause a paper jam. Always use the printer with the tray open.

CLEANING THE PRINTER

This section describes how to clean the printer in order to maintain it in good condition and print clean printouts all the time.

WARNING!

Be sure to switch off and unplug the machine before accessing the interior of the machine for cleaning, maintenance, or fault clearance. Access to a live machine's interior can cause electric shock.

CLEANING THE EXTERIOR

Clean the exterior of the printer about once a month. Wipe the parts with a wet but well-wrung soft cloth. Then wipe with another dry soft cloth. For stubborn stains, moisten a soft cloth with a small amount of neutral detergent, and gently wipe the stain off.

Important:

- > Do not spray the detergent directly on the printer. The liquid detergent may enter the printer through a gap and cause problems. Never use cleaning agents other than water or neutral detergent.

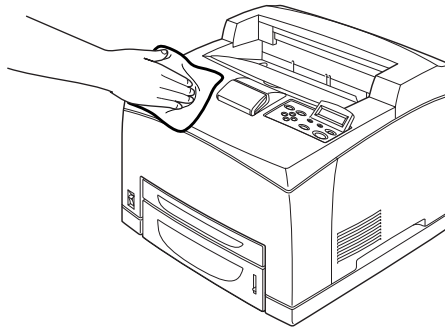

CLEANING THE INTERIOR

After clearing paper jams or replacing the drum/toner cartridge, inspect the inside of the printer before closing cover A.

WARNING!

Never touch a labelled area found on or near the heat roller. You can get burnt. If a sheet of paper is wrapped around the heat roller, do not try to remove it by yourself to avoid injuries or burns. Switch off the machine immediately, and contact service.

- > Remove any remaining pieces of paper.
- > Remove any dust or stains with a clean dry cloth.

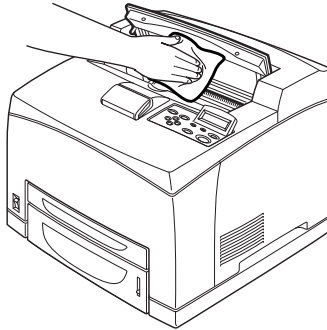

CLEANING THE FEED ROLLS

When feeding cannot be done, follow the procedure below to wipe the feed roll gently with a well-wrung soft cloth.

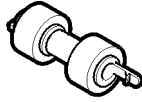

There are feed rolls in the interior of this printer (two locations, total of four), tray module (one location) and paper tray (one location). Follow the **cleaning procedure** (page 48) to clean the feed rolls at each location.

Inside of Machine (Two Locations)

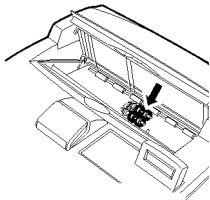

Open cover A and after removing the drum/toner cartridge, clean the feed roll.

Tray Module (One Location)

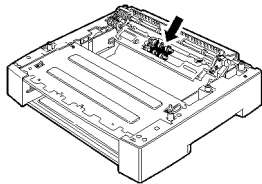

Even without uninstalling the tray module you can clean the feed roll after pulling out the paper tray.

Paper Tray (One Location)

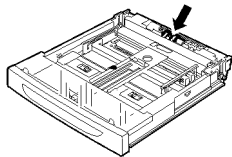

Pull out the paper tray and clean the feed roll.

Cleaning Procedure

The following procedure explains how to clean the feed roll set in the paper tray. Follow this procedure also when cleaning the feed rolls inside of the printer and the tray module.

NOTE

> *The feed roll is a regular replacement part.*

1. Pull the paper tray out of the printer.

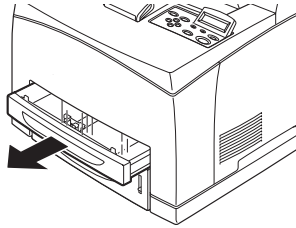

2. While pushing the retard part (see right diagram) down (1), widen the tab on the feed roll to loosen it (2) and then slowly remove the feed roll from the shaft of the paper tray (3).

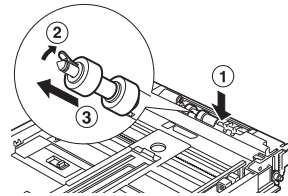

3. Wipe the rubber parts with a wet but well-wrung soft cloth.



4. Turn the short tab of the feed roll to the right and slowly push it onto the shaft of the paper tray.

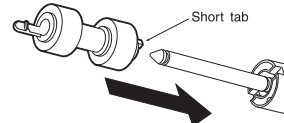

By aligning the slot of the feed roll with that of the shaft, push the feed roll completely in so that the short tab fits into the slot of the shaft.

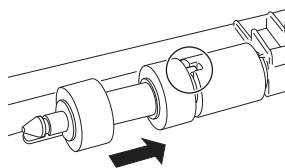

- 5.** Push the paper tray completely into the printer.

WHEN MOVING THE PRINTER

Carry out the following procedure when moving the printer.

WARNING!

- > **The machine, without the optional accessories, paper trays, consumables and paper, weighs 18.8kg. When moving the equipment, make sure that there are two or more persons carrying it.**
- > **If the duplex unit (optional) or A4 universal tray (optional) has been installed, uninstall it before moving the printer. If these are not fixed securely to the printer, they may fall to the ground and cause injuries.**
- > **When lifting the machine, be sure to observe the following points, failure to do so may cause the machine to fall and result in injuries.**
 - **2 persons, one facing the front of the machine (control panel) and the other facing the back, should firmly grip the recessed areas on the bottom part of both sides of the machine. Never try to lift the machine by gripping any other areas.**
 - **Bend your knees to avoid possible injuries to your back.**

CAUTION!

Do not tilt the machine more than 10 degrees.

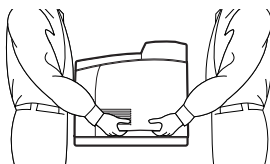

Correct Moving Procedure

Carry out the following procedure when moving the printer.

1. Press the power switch of this printer to the <O> position to switch the power off.
2. Remove all cords, such as the power cord and interface cables.
3. Remove any paper in the centre output tray and return the paper stopper to its original position if it's raised.
4. Pull out the paper tray from the printer and remove any paper in the tray.
Keep the paper wrapped and away from humidity and dirt.
5. Push the paper tray completely into the printer.
6. Open cover A but do not touch any parts inside the printer.
7. Hold the drum/toner cartridge by the grip and pull it out slowly.

CAUTION!

It is necessary to uninstall the drum/toner cartridge. If you move the printer with the drum/toner cartridge installed, the toner may spill out inside of the machine.

Do not shake the drum/toner cartridge after uninstalling it from the printer. The toner will spill.

Put the uninstalled drum/toner cartridge back into its original aluminium bag or wrap it with a thick cloth to prevent it from being exposed to strong light.

8. Close cover A securely.
9. Lift the printer and move it gently. If the printer is to be moved over a long distance, pack it inside a box.

INDEX

A

- A4 universal tray 9
- arrow buttons 10, 29
- <ATTENTION> indicator 10, 29

B

- Barcode printing 25

C

- <CANCEL> button 10, 14, 29
- cancelling printing 14
- centre output tray 7
- cleaning the feed roll 47
- cleaning the printer 45
- configuring optional accessory 15
- control panel 7, 10
- cover A 9
- cover B 9
- cover C 8
- cover D 8

D

- Delayed Print 23
- direct printing of PDF files 24
- drum/toner cartridge 9
- duplex unit 8

E

- E-mail Printing 24

F

- <FEED/SELECT> button 10, 28
- forced printing 36
- fuser unit 9

L

- LCD display 10, 29
- loading paper
 - loading envelope 17
 - loading transparencies 19
- long size 20

M

- <MENU> button 10, 28

O

- offset catch tray 8
- <ON LINE> button 10, 29
- [Options] tab 15

P

- paper meter 7
- paper transport section 32

- Paper trays
 - centre output tray 7
 - tray 1 7
 - tray 2 7
- poor print quality 39
 - black spots or streaks are printed 39
 - dirt appears at equal intervals 39
 - missing characters throughout the length of the paper 41
 - nothing is printed 40
 - printed image smudges when rubbed with your finger/the toner is not fixed on the paper 40
 - printing is light (faded, blurred) 39
 - spots of missing text 40
 - text is blurred 40
 - text or images are printed at an angle 41
 - the whole piece of paper is printed black 40
 - transparency/postcard/envelope not printed clearly 41
 - white dots appear in black filled areas 40
- <POWER SAVE> button/
indicator 10, 29
- power save modes 13
- power switch 7
- print after checking printing result -
sample print 23
- print at a specified time 23
- print confidential document 23
- printing
 - barcode printing 25
 - Delayed Print 23
 - direct printing of PDF files 24
 - E-mail Printing 24
 - printing from the computer 16
 - printing on custom size paper/
long paper 20
 - printing on envelope 17
 - printing on transparencies 19
 - Proof Print 23
 - Secure Print 23
- printing on custom size paper/long
paper 20
- printing on envelope 17
- printing on transparencies 19
- printing via electronic mail 24
- Proof Print 23

R

<READY> indicator	10, 28
rear output tray.....	8
rear output tray lever.....	9
replacing the drum/toner cartridge	42

S

Secure Print.....	23
setting custom paper size	21
switching off the power	12
switching on the power.....	12

T

transfer roll cartridge	9
troubleshooting	28, 31

W

when moving the printer	50
when paper jams.....	31
when problems occur	34
cannot print	35
envelope is wrinkled	37
light of <Error> indicator is blinking	35
light of <Error> indicator is on.....	35
network related troubles	41
no power	34
paper cannot be fed/paper jam/ multiple papers are fed/papers are fed at an angle/paper is wrinkled	37
printing is taking up a lot of time	36
strange noise.....	38
the correct characters are not printed (printing garbage).....	36
the light of the <READY> indicator is not blinking or on.....	35
the light of the <READY> indicator is on and blinking.....	36
the printout is different from what is displayed on the screen	36
top section of document is missing/ text is reduced	36

OKI CONTACT DETAILS

Oki Systems (UK) Limited

550 Dundee Road
Slough Trading Estate
Slough, SL1 4LE

Tel: 44 (0) 1753 819819

Fax: 44 (0) 1753 819899

<http://www.oki.co.uk>

Oki Systems Ireland Limited

The Square Industrial Complex
Tallaght, Dublin 24, Ireland

Tel: +353 1 4049590

Fax: +353 1 4049591

<http://www.oki.ie>

Technical Support:

Tel: +353 1 4049570

Fax: +353 1 4049555

E-mail: tech.support@oki.ie

OKI Systems (Ireland) Ltd.

(Northern Ireland)
40 Sydenham Park
Belfast, BT4 1PW

Tel: +44 (0)28 90 20 1110

<http://www.oki.ie>

Technical Support:

Tel: +44 (0)28 90 221919

E-mail: tech.support@oki.ie

OKI EUROPE LIMITED

Blays House

Wick Road

Egham, Surrey TW20 0HJ

United Kingdom

Tel: +44 (0) 208 219 2190

Fax: +44 (0) 208 219 2199

WWW.OKIPRINTINGSOLUTIONS.COM

