

# OKI

## User's Guide U00122912806

---

Solvent Ink Color Inkjet Printer

# IP-5620/5520

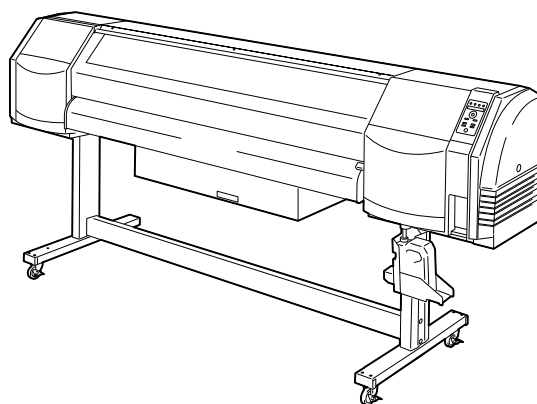

Read this User's Guide before operating the printer.

Keep this manual for future reference.

**OKI Data Infotech Corporation**

IP-5620/IP-5520 Solvent Ink Color Inkjet Printer User's Guide  
Documents Number U00122912806, Seventh Edition, December 2015

Copyright© 2015 OKI Data Infotech Corporation.

All rights reserved.

The contents of this manual may be changed without prior notice.

OKI Data Infotech Corporation. reserves the right to make changes without notice to the specifications and materials contained herein and shall not be responsible for any damages (including consequential) caused by reliance on the materials presented, including but not limited to typographical, arithmetic, or listing errors.

Please address any questions, comments, and suggestions to the regional office on:

<http://www.okidata-infotech.com/>

This guide acknowledges the following trademarks :

All other trademarks are the properties of their respective companies.

This equipment has been tested and found to comply with the limits for a Class A digital device, pursuant to Part 15 of the FCC Rules. These limits are designed to provide reasonable protection against harmful interference when the equipment is operated in a commercial environment. This equipment generates, uses, and can radiate radio frequency energy and, if not installed and used in accordance with the instruction manual, may cause harmful interference to radio communications. Operation of this equipment in a residential area is likely to cause harmful interference in which case the user will be required to correct the interference at his own expense.



The CE mark, that shows that the products sold in the EU are conformed to the requirements of EC directive, is statutorily obliged to be affixed to the products.

In each directive, the scope of directive to be applied to equipment is explicitly defined. Our company's product IP-5620/IP-5520 conforms the EMC directive, low voltage directive and RoHS Directive.

Inquiry of CE mark:

**OKI Europe Ltd.**

**Wide Format Division**

Siemensstrasse 9 , D-63263 Neu-Isenburg

Germany

Tel.: +49 (0)6102 297 400

Fax: +49 (0)6102 297 50 400

**OKI Data Infotech Corporation**

8 Nakase 1-chome, Mihama-ku, Chiba-shi, Chiba 261-8507, Japan

Phone : +81 43 211 1363

Fax : +81 43 211 8709



# ***Introduction***

---

Thank you very much for purchasing the IP-5620/IP-5520 Color Inkjet Printer (hereafter simply called the printer.)

IP-5620 supports media up to 64 inch width and IP-5520 media up to 54 inch width. The printer is a color inkjet printer using solvent ink and equipped with USB 2.0 interface.

The printer has two types of specifications, 6 color specifications and 4 color specifications, depending on the number of print heads. Also, three different types of solvent ink are supported, GX ink, IX ink, and neon ink.

This guide provides explanations for the IP-5620 6 color specifications model. However, individual information is given when necessary.

This guide, the IP-5620/IP-5520 Solvent Ink Color Inkjet Printer User's Guide, describes the features and functions of the printer and the printing procedure. In addition, troubleshooting is also included. Read the sections suitable for your purpose.

The following items should be read before using the printer to ensure correct and safe operations.

- Components delivered with this product
- Safety precautions
- Handling precautions
- Manual legend (notational rules)

Keep this manual in a place where you can quickly access it at any time.

---

# Components delivered with this product

The following components are delivered with the product.

If any item is missing or damaged, contact the dealer where the printer was purchased or the nearest service representative.

## Basic configuration item

Printer <1 unit>  
- equipped with USB interface

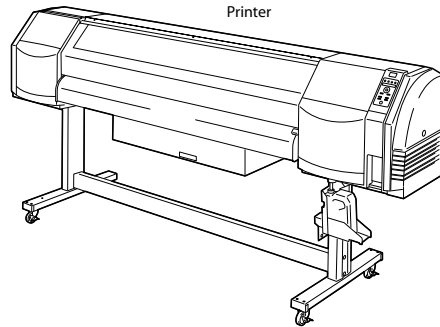

## Supplied Accessories



Power cord  
<1 piece>

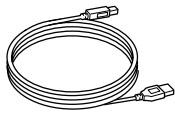

USB 2.0 cable  
<1 piece>

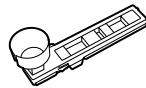

Wiper sponge  
<1 piece>



Waste ink bottle  
<1 bottle>

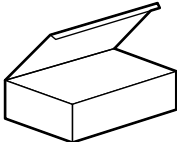

Print head kit  
6 or 4 colors



CD-ROM  
Installation Guide  
<1>



CD-ROM  
- CP Manager  
- User's Guide  
- Quick Reference Guide  
<1 piece>



PS RIP  
<1 piece >

## Required option

### Starter kit

Choose one of the following.

- GX ink 6 colors
- GX ink 4 colors
- GX ink 4 colors and neon ink 2 colors
- IX ink 6 colors
- IX ink 4 colors

\* Use neon ink in combination with GX ink (YMCK). Neon ink cannot be used with IX ink (YMCK).

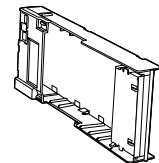

Cartridge holder  
<7 pieces>

- Ink is consumed during the initial filling when the printer is installed. Therefore, all of the ink may not be used for printing.
- Some components may not be included or available depending on the purchase area.

## Options

- Take-up reel unit (64) (IP5-268) (for IP-5620)
- Take-up reel unit (54) (IP5-269) (for IP-5520)
- Blower unit (IP-182)
- 2 inch flange (IP5-261)
- Exhaust attachment (IP-265)
- Cutter unit (64) (IP5-262) (for IP-5620)
- Cutter unit (54) (IP5-263) (for IP-5520)

## Consumables

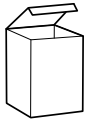

### Daily maintenance kit Type S

for GX ink for IX ink  
(IP5-325 or IP5-324)

<1 set>

- Cap cleaning liquid : 300 ml
- Wiper cleaning liquid : 200 ml
- Cleaning Swab : 10 pieces
- Cleaning stick : 1 piece
- Cleaning roller : 30 pieces
- Wiper blade (Type S) : 1 piece
- Tweezers : 1 piece



### Wiper cleaning liquid set (IP5-291 or IP5-297)

<1 set>

- Wiper cleaning liquid (200 ml) ttles



### Cap cleaning liquid set (IP5-292)

(for both GX ink and IX ink)

<1 set>

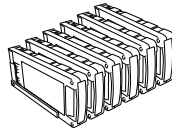

### Cleaning liquid cartridge set

for GX ink for IX ink  
(IP5-294 or IP5-298)

<1 set>

- Cleaning liquid cartridge : 6 pieces

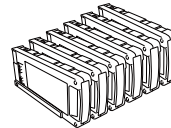

### Storage liquid cartridge set

(IP5-293)  
(for both GX ink and IX ink)

<1 set>

- Storage liquid cartridge : 6 pieces

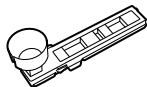

### Wiper sponge (IP5-123)

<1 piece>



### Cleaning roller set (IP5-147)

<30 pieces>



### Waste ink bottle (IP5-299)

<1 piece>



### Wiper blade (Type S) (IP5-321)

<2 pieces>

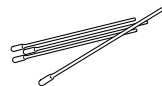

### Cleaning swab (IP6-147)

<300 pieces>

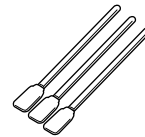

### Cleaning swab (Thick) (IP5-326)

<30 pieces>

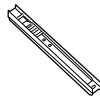

### Cap cleaning stick (IP5-120)

<1 piece>

(1 piece of cleaning roller is supplied.)



### Media cutter blade (IP5-124)

(for cutter unit (64), cutter unit (54))

<1 piece>

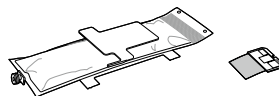

### Ink cartridge for cartridge holder and board (Y, M, C, K/Lc, Lm or Ny, Np)

As to types, refer to P.1-14.

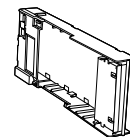

### Cartridge holder (IP5-320)

\* Options and consumables are sold separately.

\* Use the daily maintenance kit, cleaning liquid cartridge set, and wiper cleaning liquid set designed for GX ink with neon ink. Consumables designed for IX ink cannot be used.





# Safety precautions

---

The following symbols are used in this manual to ensure proper use of the printer and to prevent the printer from being damaged.

Follow the instructions marked with these symbols.

 <b>WARNING</b>	Failure to follow the guidelines marked with this symbol could result in serious personal injury or death.
 <b>CAUTION</b>	Failure to follow the guidelines marked with this symbol could result in minor personal injury or product and/or peripheral damage.

Example of symbols:



This symbol () denotes items that require special care while executing a certain procedure or operation.



This symbol () denotes items that are forbidden.



This symbol () denotes items you should follow to prevent accidents or injury.



## WARNING Be sure to read warnings below before use.



Use the power supply voltage specified on the nameplate. DO NOT plug several devices into one electrical outlet as this might result in fire or electric shock.



Make sure the printer is well grounded. If not, an electrical leak may cause fire or electrical shock.

DO NOT use electrical adapters.



DO NOT disassemble or repair the printer yourself. DO NOT block the vent. Doing so may cause an accident or a malfunction.



DO NOT damage, break, process, or heat the power cable. DO NOT pull it, bundle it up or put heavy weights on it. If it is damaged, replace it with a new one. Using a damaged power cable may cause fire or electric shock.



NEVER use the printer in a place of extreme humidity or any place where it can possibly be splashed by any liquids. If any liquids get into the printer, it could lead to fire, electric shock, or personal injury.



DO NOT allow metal or liquids to touch the internal parts of the printer. Doing so may cause fire, electric shock, or personal injury.



DO NOT disconnect or connect the power cable with wet hands. Doing so may lead to electric shock.



Power off the printer, unplug the power cable from the power outlet and ask a service center for repair in any of the following cases. Using the printer in these conditions may lead to personal injuries or fire. Never repair the printer yourself.

- Smoke, strange noise or smells generate from the printer.
- A piece of metal or any liquid touches the internal parts or slot of the printer.
- An error requiring service by a service center occurs.



DO NOT put your hand unnecessarily inside the printer parts such as covers, ventilator opening and ink cartridge slot. Doing so may result in personal injury. Even if you do not operate the printer, it may perform a function automatically. Use caution with the printer even if it is not printing.

---



The ink used for the device contains petroleum solvent. Since the ink is flammable, never operate near open flame.



DO NOT swallow ink, storage liquid, cleaning liquid, cap cleaning liquid, wiper cleaning liquid or waste ink, and avoid contact with eyes. It will cause respiratory distress and can harm the eyes. If it gets into the eyes, rinse with clean water and consult a doctor immediately. If swallowed, do not try to induce vomiting. Consult a doctor immediately.



Keep accessories and consumables such as ink cartridges and waste ink bottles out of reach of children.



DO NOT place the printer on tables or unlevel areas where it could fall. If dropped or falls, it may lead to injury. To prevent falling, lock the casters.



The heater becomes very hot. Be careful not to touch it as it may lead to burn injuries.

---



**CAUTION** Be sure to read cautions below before use.



Since the media rolls are heavy, handle them with care using a dolly or the like. If dropped, personal injury may result.



Always operate the printer in a well ventilated area. Strong ink odor is generated that may cause discomfort for the user.



Always hold the power cord or the USB cable by the plug or the connector when connecting or disconnecting the power cord or the USB cable. Never pull on the cable because this may damage it and create risk of fire, electric shock or personal injury.



DO NOT get ink on your skin or clothes. Wash off any ink immediately with soapy water.

---

**In order to ensure the safe operation of the printer, note all of the cautions and warnings contained throughout this manual.**

# Handling precautions

---

## Power supply

1. Install the printer near an easily accessible electrical outlet.
2. Do not provide power to the printer through the same power line as for noise generating devices, such as a motor.
3. Use the voltage specified on the nameplates of printer and option.
4. Turn off the power of the printer and check the following once a month.
  - 1) The power plug is securely connected to the power outlet.
  - 2) There is no dust on the power plug or the power outlet. Wipe off any dust with a dry cloth.
5. Use only 15 A rated power strips.
6. If a power strip is used with the power cord, change it for a new one every year.

## Printer

1. Do not place anything on top of the printer. Do not rest your elbows on the printer. Handle it with care. Do not do anything that will result in impact to the printer.
2. When opening or closing the cover, hold the center of the cover with both hands and open or close it gently.
3. Before connecting or disconnecting the USB 2.0 cable, turn the printer off.
4. Do not clean the surface of the cover with benzene or paint thinner. The coating may come off or deteriorate. Wipe the cover clean with a soft cloth. If the cover is very dirty, use a cloth moistened with a neutral detergent. If the printer is stained with ink, wipe it off immediately as it may affect the coating or the printer's parts.
5. Handle a print head with care. • Do not touch it unnecessarily or scratch it. • Do not touch the bottom (nozzle surface).
6. The use of consumables, accessories and options other than the products specified by OKI Data Infotech affects the printed image quality, causes damage to the printer and invalidate the warranty.

---

## Maintenance

With regard to characteristics of solvent ink, the following maintenance must be performed.

1. Check visually the remaining wiper cleaning liquid everyday.
2. Clean the Capping unit every week.
3. Perform the Print head cleaning [normal] every week.
4. Perform the service cleaning when leaving the printer for long time (2 weeks or more) in power off state.
5. Perform the head wash and the ink charge before printing after you have left the printer for long time.

For details about each maintenance, refer to **[Section 4 Maintenance and Adjustment / Replacement]**.

## Consumables

1. Using non-genuine ink may affect print quality or cause the printer to malfunction. Note that damage caused by the use of non-genuine ink is not cover by the warranty.
2. Always use the recommended ink. Failure to do this may cause poor print quality or printer damage that that may affect the printer functions.
3. Put a used ink cartridge into a plastic bag and dispose of it as industrial waste. Observe local regulations for disposal.
4. Do not get ink on your skin or clothes. Wash off any ink immediately with soapy water.
5. The level in the waste ink bottle must be periodically checked by visual inspection to prevent overflow.
6. When the waste ink bottle is installed or removed, place a sheet below so as not to stain the floor with spilled ink.
7. Store ink in a dark and cool place. NEVER store ink in a high temperature or direct sunlight. Ink characteristics change if exposed to direct sunlight.
8. Ink and storage liquid cartridges have expiration dates to ensure product quality. Use the ink cartridges and storage liquid cartridges before their expiration date.
9. Do not disassemble the ink cartridge.
10. The printer uses commercially available media designed for solvent ink. Be sure to perform test prints as the print quality varies depending on the media.

# Manual legend (Notational rules)

---

The notations used for text and keys / LCD in this guide are as follows.

## Notations



### **WARNING**

- Boxes marked with a "WARNING" describe points of caution for avoiding serious personal injury.



### **CAUTION**

- Boxes marked with a "CAUTION" describe points of caution for avoiding injury to yourself or damage to the printer.

### **Note**

- They explain the important items and cautions that should be kept in mind when operating the printer. To avoid troubles to the printer or prevent damages or wrong operation, be sure to read them.



### **Hint mark**

The hint symbol describes operations that make using or handling the printer easier.



### **Reference mark**

This mark is followed by a reference section or page number.

## Key / LCD notations

### (Example 1) Keys and LCD notations in a sentence

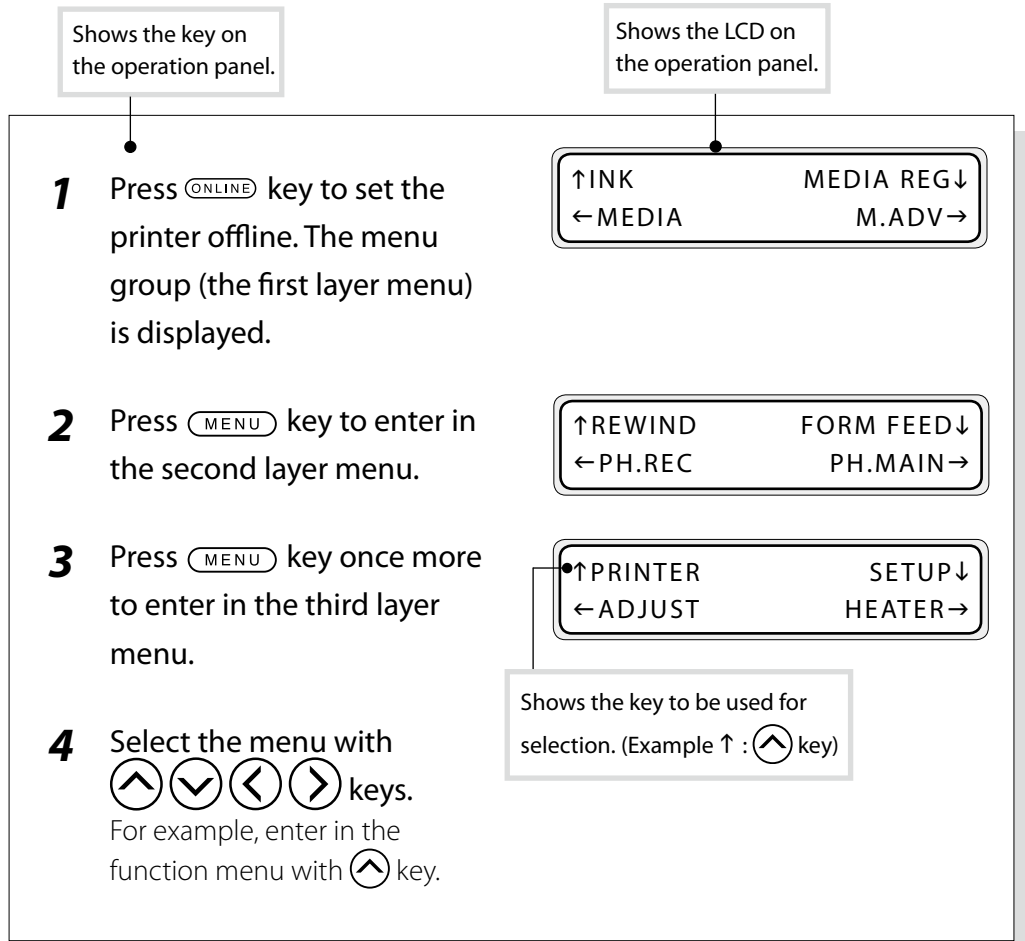

### (Example 2) Transition of LCD state in a sentence and the key operation

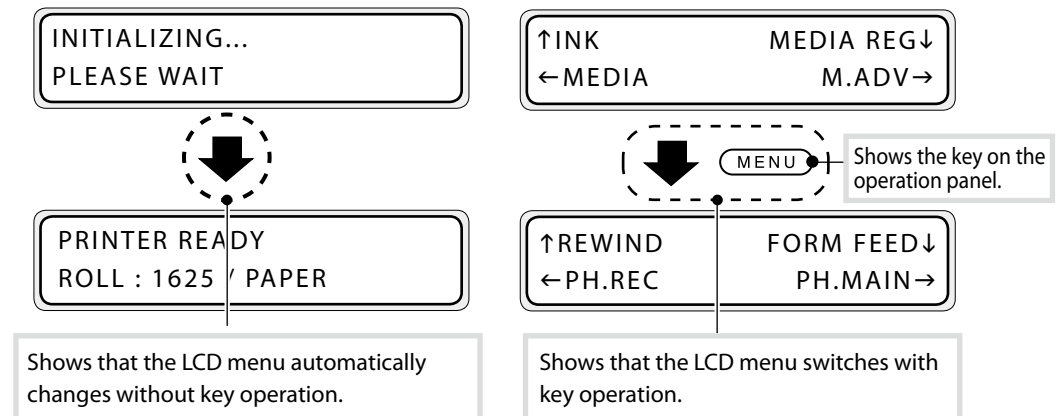

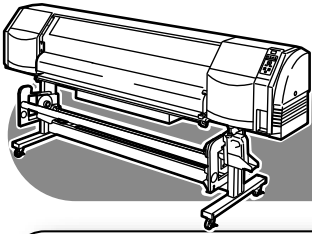

# Starting out...

**Connect to a computer.**

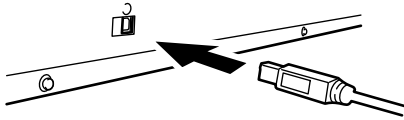

**P.2-2**

**Turn on the power.**

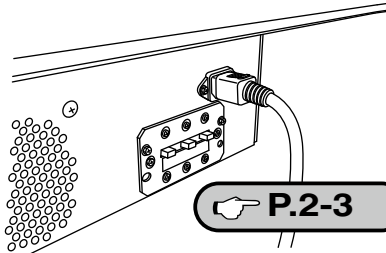

**P.2-3**

**Replace the ink cartridge.**

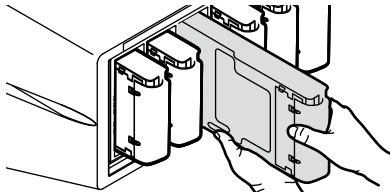

**P.2-30**

**Load the roll media.**

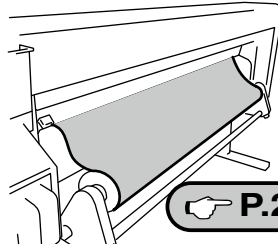

**P.2-7**

**Register the media.**

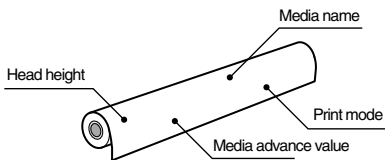

**P.2-12**

**Replace the media.**

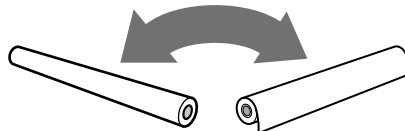

**P.2-15**

**Turn off the power.**

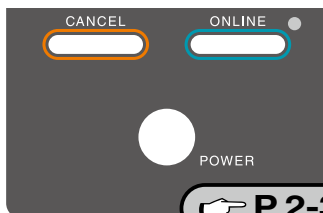

**P.2-3**



# Regular Inspection (Maintenance)

**1** Check the Waste ink bottle.

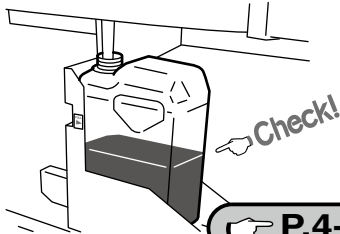

 P.4-3

**2** Check the wiper cleaning liquid.

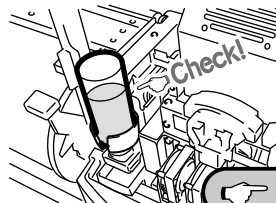

 P.4-3

**3** Check stains on the wiper blade.

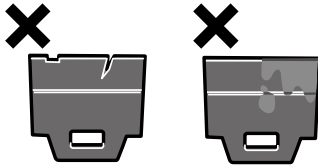

 P.4-4

**4** Clean the capping unit.

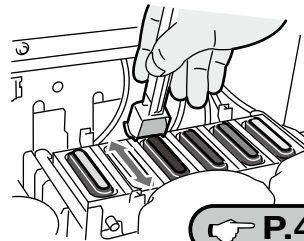

 P.4-6

**5** Perform a print head cleaning [NORMAL].

#PH RECOVERY  
>NORMAL

 P.4-24

**6** Perform a nozzle print.

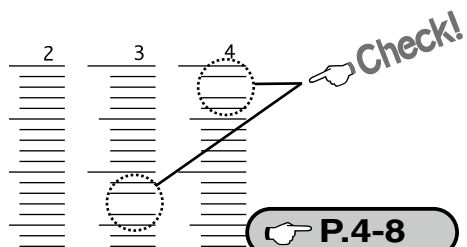

 P.4-8

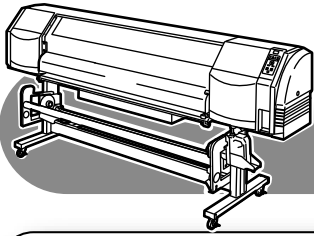

# When you want to . . .

Print on the cut media (sheet).

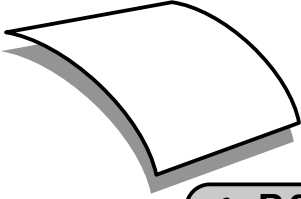

➔ P.2-17

Print on the margin of the media.

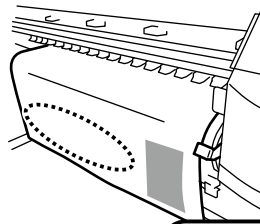

➔ P.2-23

Change the media advance value during printing.

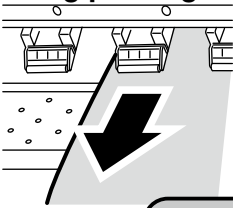

➔ P.4-32

Change the heater temperature during printing.

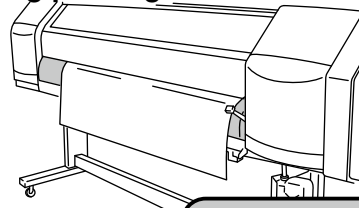

➔ P.2-27

Print on a thick media.

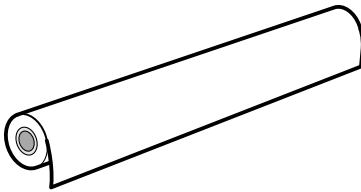

➔ P.2-28

Switch off the printer for a long period of time.

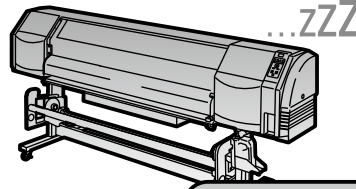

➔ P.4-15

Clean the printer.

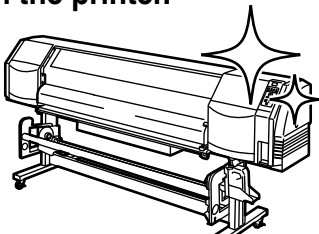

➔ P.4-19

Adjust the media during printing.

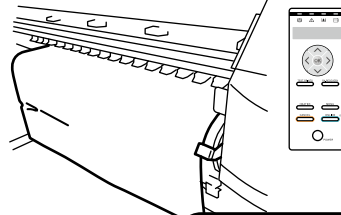

➔ P.4-39

**With new media, the printer needs to be adjusted.**



### **When replacing with a new media**



**Media advance value setting**  **P.4-32**

Adjust the advance amount of the media.



**Adjustment of the print head bidirection position**  **P.4-41**

Adjust the ink target position during bidirectional printing.

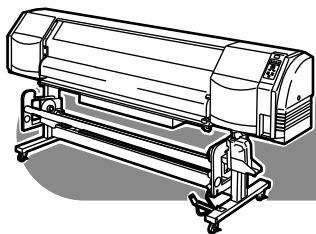

# Replacement and trouble

## Replace consumables.

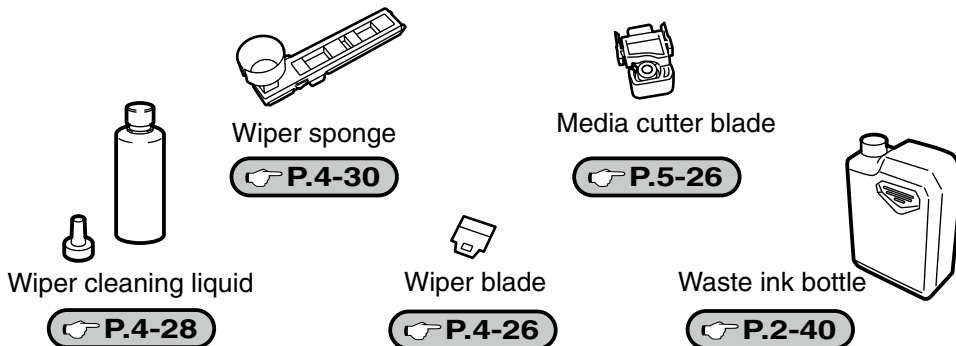

### A warning message is displayed.

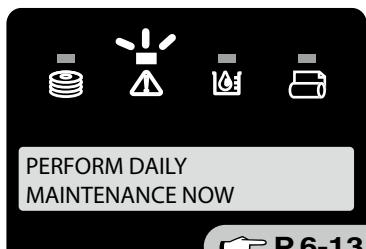

### The panel operation is not possible.

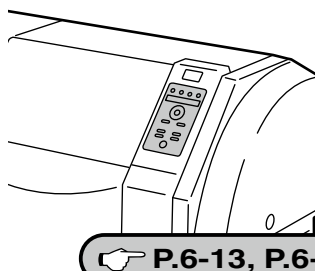

### The media is not straight.

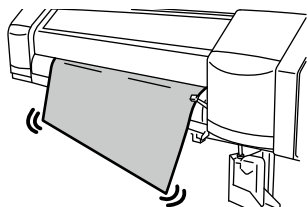

### The heater does not warm up.

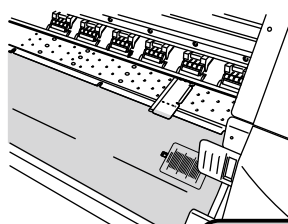

### Smears or stripes appear on the print.

**P.6-15 to**

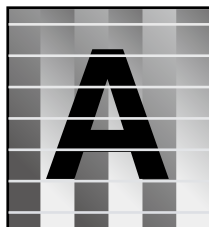
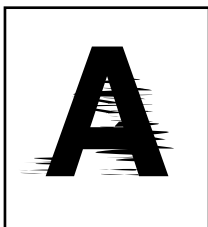
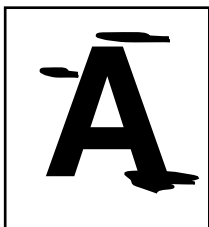

# TABLE OF CONTENTS

Components delivered with this product .....	i
Safety precautions .....	iii
Handling precautions .....	vi
Manual legend (Notational rules) .....	viii

## **Overview**

---

<b>Operating conditions</b> .....	<b>1-2</b>
Installation space .....	1-2
Environmental conditions .....	1-3
<b>Appearance / Name and function of each part</b> .....	<b>1-4</b>
Printer front (Paper exit side) .....	1-4
Printer rear (Paper feed side) .....	1-5
Print head.....	1-6
Capping unit .....	1-6
Heater .....	1-7
Operation panel .....	1-8
<b>CP_Manager</b> .....	<b>1-9</b>
<b>Options</b> .....	<b>1-10</b>
Exhaust attachment (IP-265) .....	1-10
2 inch flange (IP5-261) .....	1-10
Blower unit (IP-182) .....	1-10
Take-up reel unit (64) (IP5-268).....	1-11
Take-up reel unit (54) (IP5-269).....	1-11
Cutter unit (64) (IP5-262) .....	1-11
Cutter unit (54) (IP5-263) .....	1-11
<b>Consumables</b> .....	<b>1-12</b>
Media .....	1-12
Ink .....	1-14
Waste ink bottle .....	1-15
Daily maintenance kit .....	1-16
Cap cleaning liquid .....	1-17
Wiper cleaning liquid set .....	1-17
Cleaning stick .....	1-18
Cleaning roller set .....	1-18
Cleaning swab .....	1-18
Cleaning swab (Thick) .....	1-18
Wiper blade .....	1-18

Media cutter blade .....	1-18
Wiper sponge .....	1-19
Storage liquid cartridge set .....	1-19
Cleaning liquid cartridge set .....	1-19
<b>LCD display and state of printer .....</b>	<b>1-20</b>
How to read LCD .....	1-20

## **Basic operation**

---

<b>Connection to a computer .....</b>	<b>2-2</b>
System configuration (Connection example) .....	2-2
Connecting procedure .....	2-2
<b>Power ON / OFF procedure .....</b>	<b>2-3</b>
Power-on procedure .....	2-4
Power-off procedure .....	2-6
<b>Media replacement .....</b>	<b>2-7</b>
Roll media installation procedure .....	2-7
Roll media removal procedure .....	2-15
When replacing the roll media after it runs out .....	2-16
When replacing the roll media due to jamming .....	2-16
Cut media installation procedure .....	2-17
Cut media removal procedure .....	2-17
When using 2 inch core rolls .....	2-18
<b>How to use the media edge guards .....</b>	<b>2-19</b>
<b>How to switch the pressure .....</b>	<b>2-20</b>
<b>Feeding the media [Feed] .....</b>	<b>2-21</b>
<b>Rewind the media [Back Feed] .....</b>	<b>2-22</b>
<b>How to use the origin setting function .....</b>	<b>2-23</b>
<b>Changing temperature using the heater control menu .....</b>	<b>2-25</b>
<b>Change the Print head height .....</b>	<b>2-28</b>
<b>Ink cartridge replacement .....</b>	<b>2-30</b>
Ink cartridge replacement procedure .....	2-30
When the ink cartridge is empty and it needs to be replaced .....	2-31
When no ink cartridge is installed .....	2-31
When the ink cartridge is not recognized .....	2-31
<b>Reloadable cartridge replacement .....</b>	<b>2-32</b>
Used ink cartridge removal procedure .....	2-33
Ink cartridge installation procedure .....	2-35
<b>Waste ink bottle replacement .....</b>	<b>2-40</b>
Waste ink bottle replacement procedure .....	2-40
When no waste ink bottle is installed .....	2-42
<b>The media was skewed. ....</b>	<b>2-43</b>

## **Menu of Operation panel**

---

Basic menu operation in offline mode .....	3-2
Menu layer structure .....	3-3
Menu tree .....	3-4
Basic operation procedure and keys used .....	3-10
Procedure selection, numerical input, execution and character input .....	3-11
Explanation of each menu operation .....	3-17
INK MENU .....	3-17
MEDIA MENU .....	3-18
MEDIA REG MENU .....	3-20
M.ADV MENU .....	3-40
REWIND MENU .....	3-46
PH.REC MENU .....	3-47
FORM FEED MENU .....	3-48
PH.MAIN MENU .....	3-49
PRINTER MENU .....	3-52
ADJUST MENU .....	3-53
SETUP MENU .....	3-57
HEATER MENU .....	3-62

## **Maintenance and Adjustment / Replacement**

---

Periodic maintenance .....	4-2
Periodic inspection and maintenance guide .....	4-2
Strong cleaning .....	4-11
Fill the cap with ink .....	4-12
Fill the cap with wiper cleaning liquid .....	4-13
Cleaning .....	4-19
Print head cleaning .....	4-24
Operating procedure of print head cleaning .....	4-24
Wiper blade replacement .....	4-26
Wiper cleaning liquid replacement .....	4-28
Wiper sponge replacement .....	4-30
Media advance value setting .....	4-32
Media advance value setting procedure .....	4-32
Change during online printing .....	4-36
Change the media type registered without setting the media again .....	4-37
Adjust the margin to the previous printout before printing .....	4-38
Set the edge guards again during printing .....	4-39
Remove media wrinkles during printing .....	4-40

Head position adjustment .....	4-41
BIDIRECTIONAL ADJUSTMENT method .....	4-42
[PRINT HEAD ADJUST] adjustment procedure .....	4-47
[EDGE SENSOR ADJUST] adjustment procedure .....	4-50

## ***How to use options***

---

How to use the take-up reel unit .....	5-2
Install the media on the take-up reel unit .....	5-3
Tension take-up / Loose take-up setting .....	5-7
Take-up switch setting .....	5-8
Using a 2 inch core .....	5-9
When the media cannot be wound properly in loose take-up using the type without rear sensor .....	5-10
Adjustment of the take-up reel unit .....	5-19
Initial adjustment .....	5-19
Adjustment during operation .....	5-21
How to use the blower unit (option) .....	5-23
Normal utilization.....	5-23
Handling the media .....	5-24
Cut the media .....	5-25
Media cutter blade replacement .....	5-26

## ***Troubleshooting***

---

When encountering a problem .....	6-2
How to clear media jams .....	6-6
When an error message is displayed .....	6-7
Service call error .....	6-7
Operator call error .....	6-8
When a warning message is displayed .....	6-13
How to get good image quality .....	6-15
Abnormal sound .....	6-23

## ***Appendix***

---

Basic specifications .....	A-2
Printer Specifications .....	A-2
Options / Consumables .....	A-3
Options .....	A-3
Consumables .....	A-3



# 1

## Overview



This section describes the information needed before using the printer (basic knowledge). After reading this section, proceed to section 2.

---

(Content in this section)

Operating conditions.....	1-2
Appearance / Name and function of each part .....	1-4
CP_Manager.....	1-9
Options .....	1-10
Consumables .....	1-12
LCD display and state of printer.....	1-20

# Operating conditions

This section describes the operating conditions required for the printer.

## Installation space

The adequate space is required around the printer for normal operations, including consumables replacement, print processing, blower unit shifting and ventilation, as well as parts replacement for repairing. Be sure to secure the space indicated in the picture below.

### ■ Installation and maintenance space

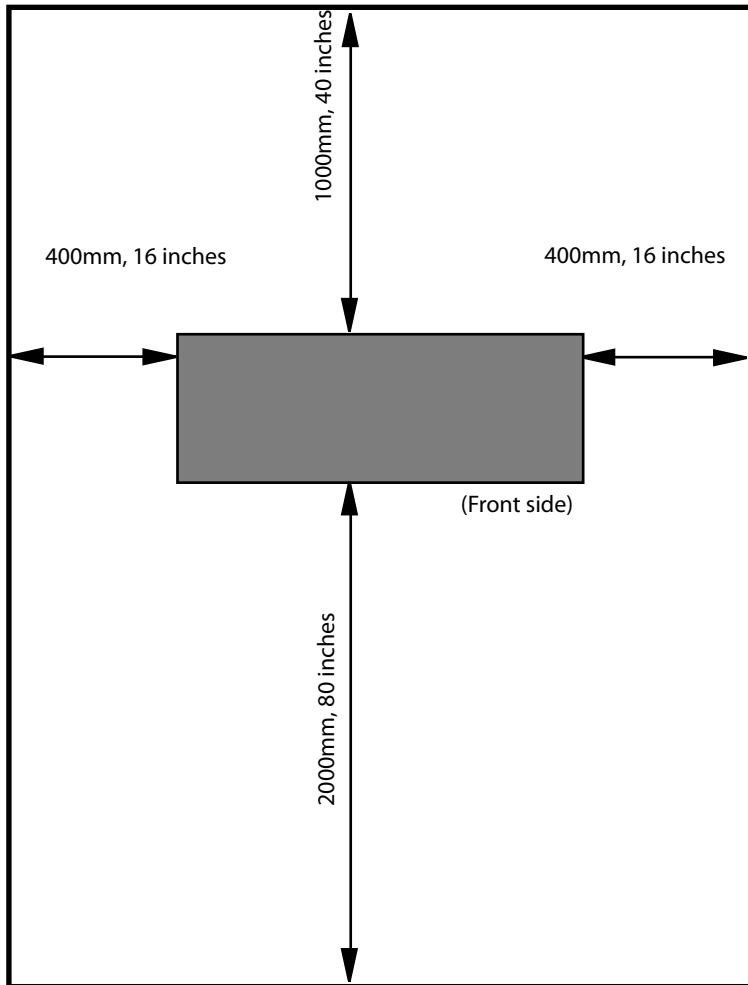

Height direction : 1750  
(Unit : mm)

## Environmental conditions

### ■ Operating temperature and humidity ranges

The printer should be used within the temperature and humidity ranges shown below.

**Temperature : 15 °C to 30 °C (60 °F to 86 °F)**

**Humidity : 30% to 70%**

- ◇ To obtain better print quality, use the printer within temperatures of 20 to 25 °C (68 °F to 77 °F.)
- ◇ To keep a stable and good print quality, the printer slows down the print speed when the operating temperatures exceeds 41 °C (106°F).



#### Note

- **When the printer is used out of the operating temperature and humidity ranges, the print quality may be degraded and/or print may be stopped.**
- **It takes time for the printer to adapt to the operating environment temperature and humidity. To get good printed image quality, it is recommended to keep the room temperature 20 to 25°C , 68 to 77°F and use the printer after at least 1 hour.**

### ■ Places where the printer must not be installed

Do not install the printer in the following places:

- ◇ Places exposed to direct sunlight
- ◇ Places subject to vibration
- ◇ Places with excessive dust
- ◇ Places subject to extreme changes in temperature or humidity
- ◇ Places near an air conditioner or a heater
- ◇ Places where the printer may get wet
- ◇ Places subject to direct air circulation from vents
- ◇ Places near a diazo copier that may generate ammonia gas
- ◇ Places with poor ventilation
- ◇ Unstable places

# Appearance / Name and function of each part

The printer is shown with the name and function of each component.

## Printer front (Paper exit side)

### Front cover

Close it when printing.

### Maintenance cover

Open it when performing the print head maintenance (replacement and height adjustment).

### Pressure roller up/down lever

This lever fixes or releases the media.

### Cap cover

Open it when cleaning the capping unit or replacing the wiper blade.

### Operation panel

Includes the lamps and LCD to display the status of the printer and keys to set the various functions.

### Take-up reel unit (option)

### Media clip (option)

After cutting the media, clip it to not let it fall.

### Front paper guide

Includes the after heater used to dry the ink.

### Media cutter blade (option)

It cuts the media.

### Waste ink bottle

### Media clip (option)

After cutting the media, clip it to not let it fall.

### Grit roller

The grit roller advances or rewinds the media.

### Pressure roller

When lowering the pressure roller up/down lever, it pinches the media.

### Platen

It is the media path. To prevent the media from floating, a suction fan is built in it, as well as a heater to fix the ink.

### Media edge guard

It protects the print head from curls and irregularities at both edges of a media.

### Paper ejection sensor

It detects the presence/absence of a media.

## Printer rear (Paper feed side)

### Pressure roller up/down lever

This lever fixes or releases the media. It is inter-linked with the pressure roller up/down lever on the front of the printer.

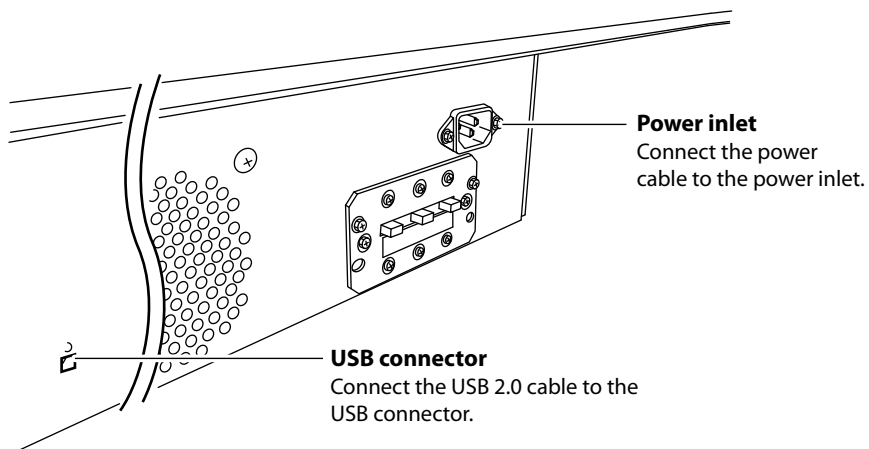
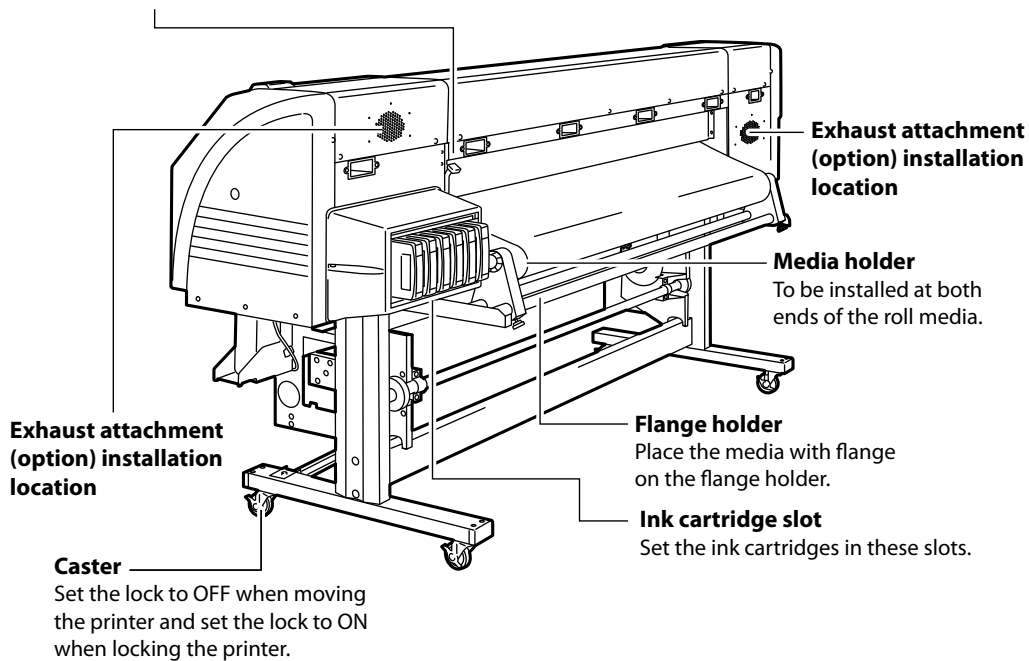

---

## Print head

### Head up down mechanism

By lowering the lever, the print head position rises by 0.5mm.

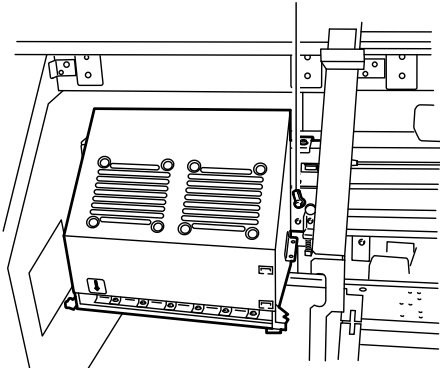

## Capping unit

### Wiper blade

It removes foreign matters on the surface of the nozzles of the print head.

### Capping unit

It prevents the nozzles of the print head from drying.

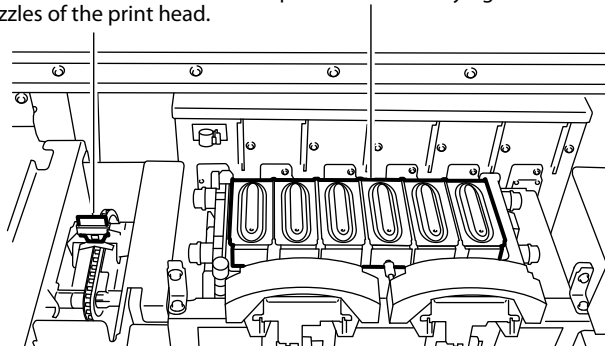

## Heater

This printer is equipped with three heaters for ink fusing and image quality stabilization.

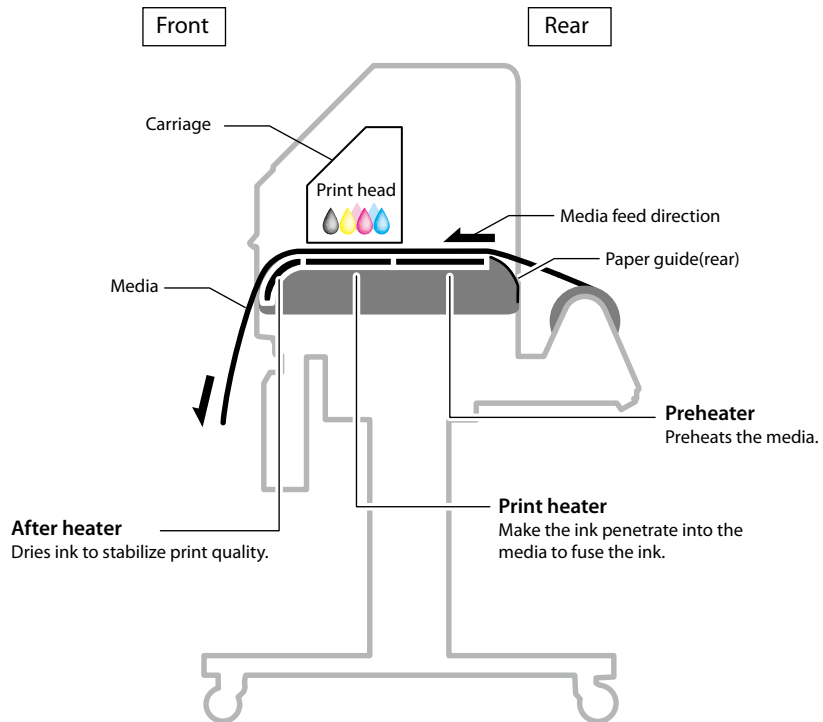

\* These three heaters are controlled independently.

☞ ( P.2-25 [Changing temperature using the heater control menu])

## Operation panel

The keys, LEDs and LCD are laid on the operation panel of the printer as shown below. The buzzer is to notify the operator when an error occurs or an invalid key is pressed.

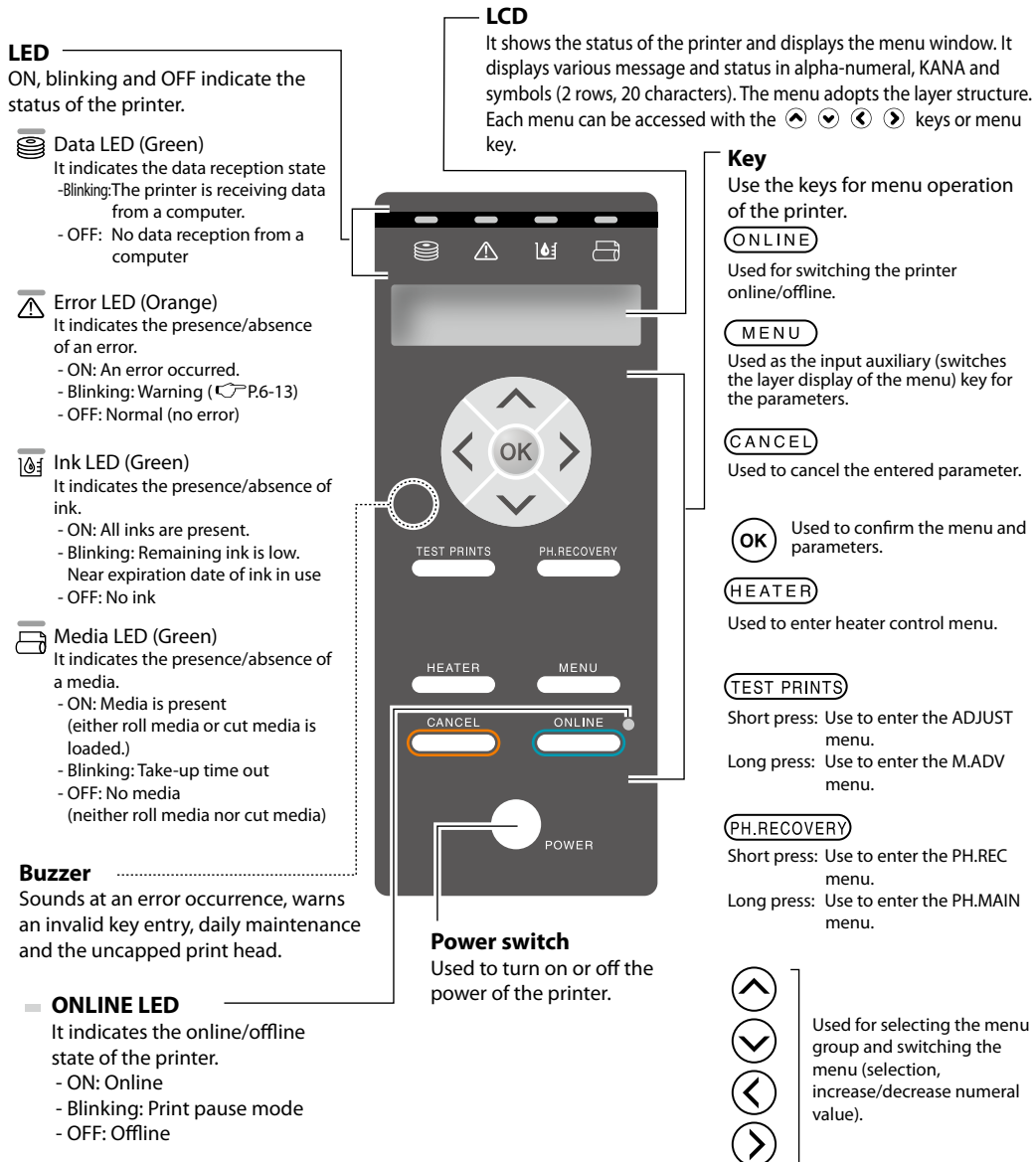



# CP\_Manager

The Printer supports the CP\_Manager software that provides a general view of the Printer status. The following operations can be performed with CP\_Manager™.

### Panel operations

- Display Printer status
- Create media preset, input adjustment values
- Execute nozzle printing, adjustment patterns printing
- Maintenance time notice, maintenance operation.

### Additional functions

- Display operation guidance
- Display the instruction manual (PDF)

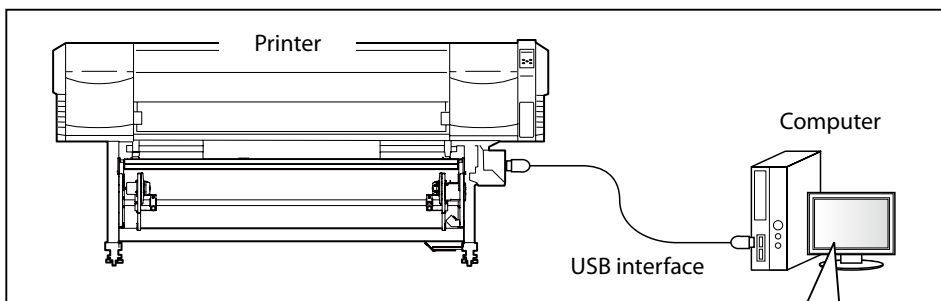

### CP\_Manager display example

The screenshot shows the CP\_Manager software interface. On the left is a 'Printer status display' panel with a 'PAPER' section showing ink levels for Cyan, Magenta, Black, and Yellow, and a 'Heater' section with temperature indicators. The main area is titled 'Media preset' and contains various configuration options such as 'Preset No.', 'Media Name', 'Print Mode', 'Density', 'Print Direction', 'Smart Pass', 'Advance Value Priority', 'Print Mode Priority', 'Heater Temperature Priority', 'PH Rest. Interval', 'PH Rest. Time', 'Remaining Media', 'Media Advance Value', 'Bidr. Adjustment 1', 'Bidr. Adjustment 2', and 'Bidr. Adjustment 3'. A callout box labeled 'Media preset' points to the 'Media Name' field.

Install CP\_Manager™ using the CD-ROM supplied with the Printer.

# Options

## Exhaust attachment (IP-265)

An optional unit to attach an exhaust duct to the printer.

Recommended air flow:

0.1 to 0.6 CMM

\*CMM= Cubic meter per minute

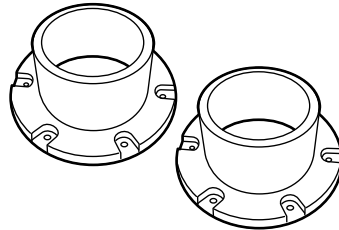

## 2 inch flange (IP5-261)

This flange is used to load the roll media of 2 inch core.

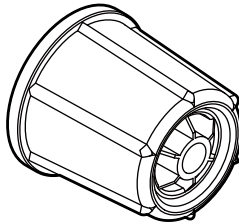

## Blower unit (IP-182)

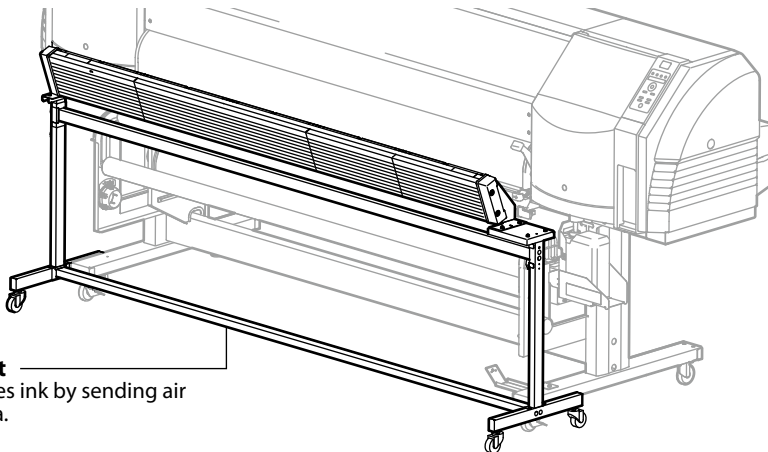

**Blower unit**

This unit dries ink by sending air to the media.

---

**Take-up reel unit (64) (IP5-268)**

This unit is used to reel in the printed media. (For IP-5620)

**Take-up reel unit (54) (IP5-269)**

This unit is used to reel in the printed media. (For IP-5520)

**Cutter unit (64) (IP5-262)**

This unit is used to cut the printed media manually. (For IP-5620)

**Cutter unit (54) (IP5-263)**

This unit is used to cut the printed media manually. (For IP-5520)

# Consumables

---

## Media

### ■ Type of media

The printer uses the following commercially available media for solvent ink. Printing conditions may vary depending on the installation environment and the media lot. We recommend you perform test prints before printing. For more details, contact your dealer or OKI Data Infotech sales.

- Glossy vinyl chloride
- Matte vinyl chloride
- Tarpaulin

### ■ Precautions for storing media

- ◇ Avoid direct sunlight and water regardless of before and after opening the package. Put media in plastic to prevent exposure to dust and store media in a dry, cool and dark place.
- ◇ Avoid rapid change of temperature and humidity and store media in a place with no condensation.
- ◇ Do not store media in standing position to prevent unraveling of media and damage to roll edge.
- ◇ Do not pile up media rolls.
- ◇ Roll media is heavy, so take the necessary safety measures when storing it. If roll media rolls or falls, it may lead to personal injuries.

### ■ Precautions for disposing of media

- ◇ Dispose of media and printouts in a manner consistent with local regulations.

---

## ■ Precautions for preparing media

- ◇ Avoid a change in temperature and humidity after opening the package. Load media after leaving the media in the operation environment for 3 hours or more. Be careful of humidity changes when turning air conditioners ON or OFF.
- ◇ Curl of paper in low humidity and wrinkle of media in high humidity may occur depending on the media characteristics. Use paper in normal temperature and humidity environment (around 23 °C, 73 °F and 50% RH).
- ◇ Do not damage the media. The roll edges are important for media feeding. Also, do not drop or wet the media. Doing so may cause print quality problems or damage to the printer.
- ◇ Hold edges of the media so as not to touch the print surface. Soiling the print surface may cause poor print quality.
- ◇ Fix unraveling of the roll media before loading.

## ■ Precautions for handling prints.

- ◇ Do not touch the print surface before the ink dries. Handle by the edges of the media. Attention must be paid during the first 24 hours.
- ◇ Rubbing print surface causes color fading or color transfer. To prevent color transfer, do not stack prints.
- ◇ Do not stack printed media on printouts from copier or laser printer. This may damage the prints.
- ◇ Do not rub, scratch, or fold the printed surface of media. Color may be lost or the surface (coated layer of the media) may come off.
- ◇ Do not leave the paper in wet environment.

## ■ Other precautions of media

- ◇ Old media may change in quality or cause color fading. Use media in good conditions.
- ◇ Dust and debris produced when cutting the media may damage the media.
- ◇ When an adhesive media is used, the platen may be stained with adhesive from the media. In this case, wipe the adhesive off the platen, referring to **[Section 4 Maintenance and Adjustment / Replacement]**. Otherwise, the adhesive may cause media jams.
- ◇ Print quality varies depending on media. Always check your printouts.

## Ink

### ■ Ink types

Use only the recommended ink cartridges listed below.

(Ink cartridges using the cartridge holder)

Type	Content	Quantity	Type	Content	Quantity
IP5-301	Y (Yellow) (GX ink)	500 ml	IP5-311	Y (Yellow) (IX ink)	500 ml
IP5-302	M (Magenta) (GX ink)	500 ml	IP5-312	M (Magenta) (IX ink)	500 ml
IP5-303	C (Cyan) (GX ink)	500 ml	IP5-313	C (Cyan) (IX ink)	500 ml
IP5-304	K (Black) (GX ink)	500 ml	IP5-314	K (Black) (IX ink)	500 ml
IP5-305	Lc (Light cyan) (GX ink)	500 ml	IP5-315	Lc (Light cyan) (IX ink)	500 ml
IP5-306	Lm (Light magenta) (GX ink)	500 ml	IP5-316	Lm (Light magenta) (IX ink)	500 ml
IP5-451	Ny (Neon yellow) (Neon ink)	500 ml			
IP5-452	Np (Neon pink) (Neon ink)	500 ml			



### Note

- Use only the recommended ink cartridges.
- Failure to use the recommended ink cartridges may lead to a deterioration of the print quality or a printer malfunction. In this condition, proper operation of the printer cannot be guaranteed.
- The GX ink expiration date is 14 months from the date of production.
- The neon ink expiration date is 12 months after the date of production.
- The IX ink expiration date is 12 months from the date of production.
- Using an ink cartridge after the expiration date may lead to a deterioration of the print quality or a printer malfunction.
- Store ink cartridges in cool and dark places.
- Do not agitate ink cartridges before use.
- Install all the 6 ink cartridges (4 when 4 color specifications). If you remove any of the cartridges, install a new one.
- All the used ink cartridges must be of the same type (GX ink or IX ink)
- Use neon ink in combination with GX ink (YMCK).
- Contact your dealer or a sales representative to change the ink type.

Ink cartridges must be installed in all the 6 slots (4 when 4 color specifications). Each color must be installed in its dedicated slot. (See the figure to the right)

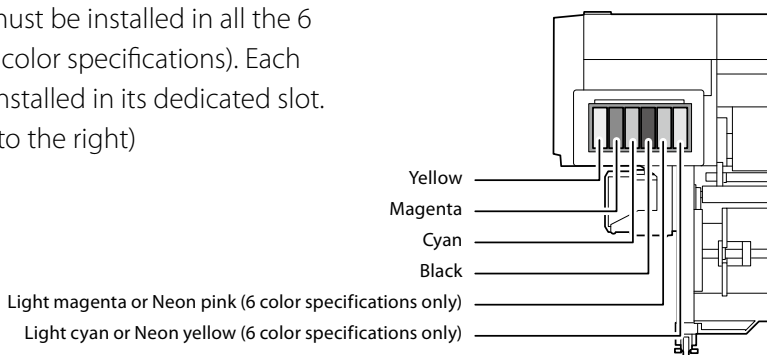



**Note**

- Do not force ink cartridges in the wrong slot.



**WARNING**

- Never place the ink close to open flames. Doing so will create a fire hazard.
- Do not swallow ink and avoid contact with eyes. It will cause respiratory distress and can harm the eyes. If it gets into the eyes, rinse with clean water and consult a doctor immediately. If it is swallowed, do not try to induce vomiting. Seek medical attention immediately.



**Note**

- Do not disassemble the ink cartridge.

■ Precautions for ink storage and processing



**Note**

Put a used ink cartridge into a plastic bag and dispose of it as industrial waste. Observe local regulations for disposal.

**Waste ink bottle**

Use the recommended waste ink bottle listed below.

Type	Content	Quantity
IP5-299	Waste ink bottle	1 piece



**WARNING**

- Never put the waste ink bottle near open flames. Doing so may cause a fire hazard.
- Do not swallow waste ink and avoid contact with eyes. It will cause respiratory distress and can harm the eyes. If it gets into the eyes, rinse with clean water and consult a doctor immediately. If it is swallowed, do not try to induce vomiting. Seek medical attention immediately.



**Note**

- Install the waste ink bottle securely.
- A waste ink bottle must always be installed. If it is removed for replacement, a new one (empty) must be installed.

---

## ■ Precautions for handling the waste ink bottle



### Note

- **After use, securely fasten the attached cap and dispose of this product as industrial waste. Observe local regulations for disposal.**
- **Always wear gloves when you dispose of waste ink.**

## Daily maintenance kit

Use the following cleaning liquid, cleaning stick, cleaning roller, cleaning swab, wiper blade, and tweezers specified by OKI Data Infotech.

Type	Content	Quantity	Type	Content	Quantity
IP5-325	Daily maintenance kit Type S (for GX ink)	1 set	IP5-324	Daily maintenance kit Type S (for IX ink)	1 set
	Cap cleaning liquid	300 ml		Cap cleaning liquid	300 ml
	Wiper cleaning liquid (for GX ink)	200 ml		Wiper cleaning liquid (for IX ink)	200 ml
	Cleaning swab	10 pieces		Cleaning swab	10 pieces
	Cleaning stick	1 piece		Cleaning stick	1 piece
	Cleaning roller	30 pieces		Cleaning roller	30 pieces
	Wiper blade (Type S)	1 piece		Wiper blade (Type S)	1 piece
	Tweezers	1 piece		Tweezers	1 piece



### WARNING

- **Do not swallow cleaning liquid and avoid contact with eyes. It will cause respiratory distress and can harm the eyes. If it gets into the eyes, rinse with clean water and consult a doctor immediately. If it is swallowed, do not try to induce vomiting. Seek medical attention immediately.**
- **Do not keep the cap cleaning liquid and the wiper cleaning liquid in a high temperature place or in direct sunshine. Never place the cap cleaning liquid and the wiper cleaning liquid close to open flames. Doing so will create a fire hazard.**



### Note

- **Use the wiper cleaning liquid only for the designated purpose.**
- **Use the maintenance kit designed for GX ink with neon ink. The maintenance kit designed for IX ink cannot be used.**



## Cap cleaning liquid

Use the following cap cleaning liquid specified by OKI Data Infotech.

Type	Content	Quantity
IP5-292	Cap cleaning liquid (for both GX and IX inks) (300 ml)	1 piece



### WARNING

- Do not swallow cap cleaning liquid and avoid contact with eyes. It will cause respiratory distress and can harm the eyes. If it gets into the eyes, rinse with clean water and consult a doctor immediately. If it is swallowed, do not try to induce vomiting. Seek medical attention immediately.
- Do not keep the cap cleaning liquid bottle in a high temperature place or in direct sunshine. Never place the cap cleaning liquid close to open flames. Doing so will create a fire hazard.

## Wiper cleaning liquid set

Use the following wiper cleaning liquid specified by OKI Data Infotech.

Type	Content	Quantity
IP5-291	Wiper cleaning liquid (for GX ink) (200 ml)	3 pieces
IP5-297	Wiper cleaning liquid (for IX ink) (200 ml)	3 pieces



### WARNING

- Do not swallow wiper cleaning liquid and avoid contact with eyes. It will cause respiratory distress and can harm the eyes. If it gets into the eyes, rinse with clean water and consult a doctor immediately. If it is swallowed, do not try to induce vomiting. Seek medical attention immediately.
- Do not keep the wiper cleaning liquid bottle in a high temperature place or in direct sunshine. Never place the wiper cleaning liquid close to open flames. Doing so will create a fire hazard.



### Note

- Use the wiper cleaning liquid set designed for GX ink with neon ink. The wiper cleaning liquid set designed for IX ink cannot be used.

---

## Cleaning stick

Use the following cleaning stick specified by OKI Data Infotech.

Type	Content	Quantity
IP5-120	Cleaning stick (for both GX and IX inks)	1 piece
	Cleaning roller (for both GX and IX inks)	1 piece

## Cleaning roller set

Use the following cleaning roller specified by OKI Data Infotech.

Type	Content	Quantity
IP5-147	Cleaning roller (for both GX and IX inks)	30 pieces

## Cleaning swab

Use the cleaning swab specified by OKI Data Infotech.

Type	Content	Quantity
IP6-147	Cleaning swab (for both GX and IX inks)	300 pieces

## Cleaning swab (Thick)

Use the following cleaning swab instead of cleaning rollers when cleaning the caps.

Type	Content	Quantity
IP5-326	Cleaning swab (Thick)	30 pieces

## Wiper blade

Use the following wiper blade specified by OKI Data Infotech.

Type	Content	Quantity
IP5-321	Wiper blade (Type S) (for both GX and IX inks)	2 pieces

## Media cutter blade

Use the following media cutter blade specified by OKI Data Infotech.

Type	Content	Quantity
IP5-124	Media cutter blade (for both GX and IX inks)	1 piece

## Wiper sponge

Use the following wiper sponge specified by OKI Data Infotech.

Type	Content	Quantity
IP5-123	Wiper sponge (for both GX and IX inks)	1 piece

## Storage liquid cartridge set

Use the following storage liquid cartridge specified by OKI Data Infotech.

Type	Content	Quantity
IP5-293	Storage liquid cartridge (for both GX and IX inks)	6 pieces



### WARNING

- **The expiration date of storage liquid cartridges is 24 months after the manufacturing date.**
- **Using a storage liquid cartridge with an expired date will not only affect print quality, but may also cause damage to the printer.**

## Cleaning liquid cartridge set

Use the following cleaning liquid cartridge specified by OKI Data Infotech.

Type	Content	Quantity
IP5-294	Cleaning liquid cartridge (for GX ink)	6 pieces
IP5-298	Cleaning liquid cartridge (for IX ink)	6 pieces



### WARNING

- **Use the cleaning liquid cartridge set designed for GX ink with neon ink. The cleaning liquid cartridge set designed for IX ink cannot be used.**

# LCD display and state of printer

This section explains how to read the LCD display and the state of the printer. When using neon ink, Lc is displayed as Ny (neon yellow) and Lm is displayed as Np (neon pink) on the LCD panel.

## How to read LCD

### (1) Initialization display

Shows the initialization of the printer when the start-up is being processed.

- When the printer starts up normally, it automatically enters the idle online mode.

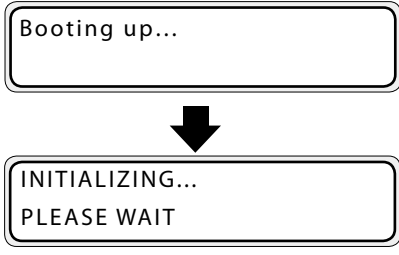

### (2) Online state (idle mode) display

Shows the printer is ready to receive data from the computer (the online LED is on.)

- Select the meter unit system or the inch unit system to display the media width in [LENGTH UNITS] of the system menu (P.3-58). In this manual, the meter unit system is used.

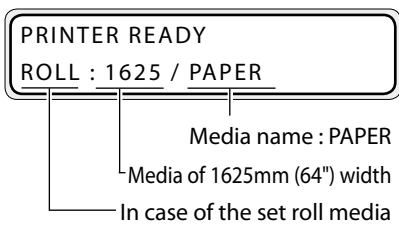

### (3) Online state (print mode) display

Shows that the data is being printed.

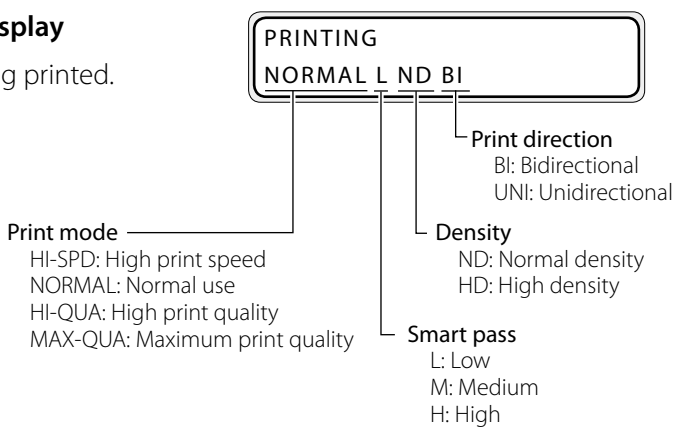

#### (4) Online state (waiting for print) display

Shows that print heads are waiting for printing, data transfer or warm up instruction.



#### (5) Online state (print pause mode) display

Shows an interrupted state during printing.

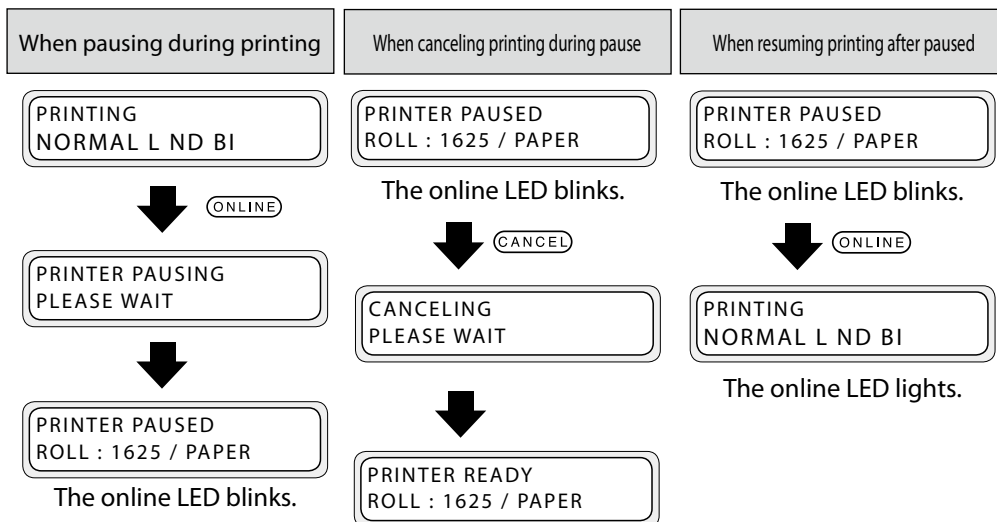

- By pressing the **PH RECOVERY** key during pause (in the state of online LED blinking), cleaning of the print heads can be executed.

#### (6) Online state (preheating)

This message indicates that the heater is in heating process to reach the preset temperature.



#### (7) Online state (during head warming-up)

This message indicates that the heads are warming up.



- Head warming-up is conducted when the head temperature is low.

**(8) Online state (print information mode) display**

Shows the media used, remaining ink, and remaining media.

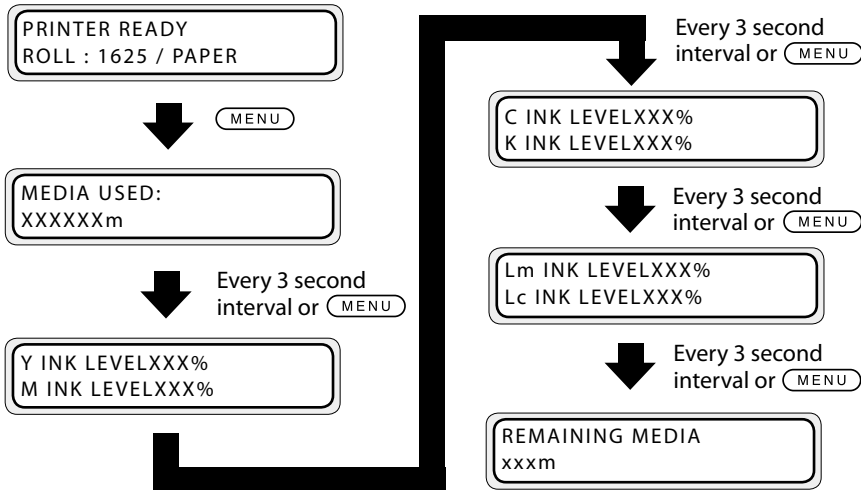

The display next returns to the online state.

- Lm, Lc, Ny, and Np INK LEVEL information is not displayed for 4 color specifications printer.



- [YY INK LEVELLOW] is displayed when the remaining ink becomes low.

When the daily maintenance is not performed or the life and replacement time of consumable parts approaches, the following messages appear.

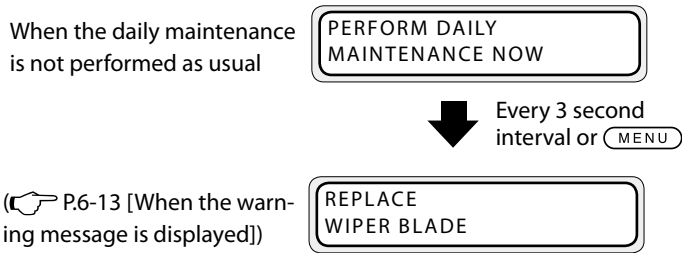

The display next returns to the online state.

**(9) Offline state (menu mode) display**

Shows that the menu operations are available in the offline state.

(☞ P.3-2 [Basic menu operation in offline mode])

- denotes the access key to each menu.

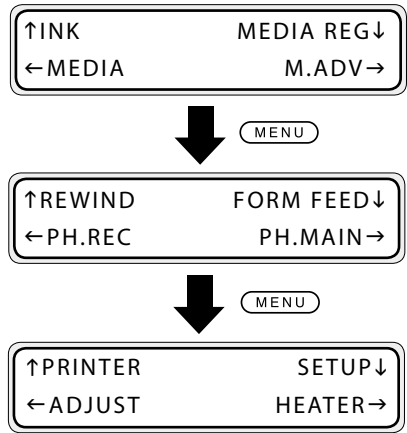

**(10) Shutdown state display**

This message indicates that the shutdown process of the printer is being executed.







# 2

## *Basic operation*

This section describes the basic operation of the printer, such as turning the printer on and off and media replacement.

---

(Content of this section)

Connection to a computer .....	2-2
Power ON / OFF procedure.....	2-3
Media replacement .....	2-7
How to use the media edge guards .....	2-19
How to switch the pressure.....	2-20
Feeding the media [Feed] .....	2-21
Rewind the media [Back Feed].....	2-22
How to use the origin setting function .....	2-23
Changing temperature using the heater control menu.....	2-25
Change the Print head height .....	2-28
Ink cartridge replacement .....	2-30
Reloadable cartridge replacement.....	2-32
Waste ink bottle replacement .....	2-40
The media was skewed.....	2-43

# Connection to a computer

This section describes the procedure to connect the printer to a computer.

## System configuration (Connection example)

See below.

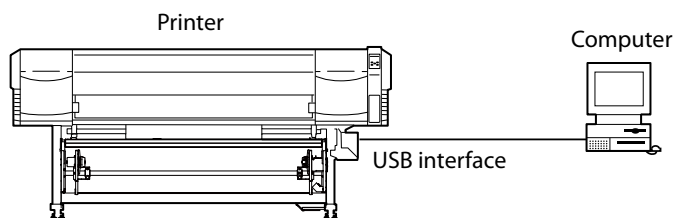

## Connecting procedure

Connect the cable following the procedure below.

- 1 Turn off the power of the printer and computer to be connected.

### Note

- When the printer and a computer are connected, turn on the power of the printer first and turn off the power of printer last when powering them down.

- 2 Connect the specific cable to the USB connector at the rear of the printer.

### Note

- Use a USB 2.0 cable.
- When using a USB hub, use a product that supports USB 2.0.
- For the cable and hub used for USB connection to the system, use USB-IF approved products. When connecting the non-approved USB cable, hub and equipment, the printer may not function properly.
- The maximum length of one cable is 5 m. If you desire to extend longer than 5 m, use a hub. The maximum length configuration is 5 stage hub connection. If a cable longer than 5 m is used or if the cables are merely connected, the printer may not function properly.
- To protect the USB connector, clamp the USB 2.0 cable to the printer body.

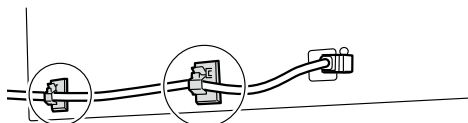
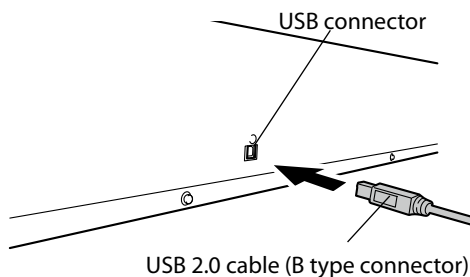

# Power ON / OFF procedure

---

Use the power switch on the operation panel of the printer to turn the power on or off.

---

## Note

- **When the printer and a computer are connected, turn on the power of the printer first and turn off the power of the printer last when powering them down.**

## Power-on procedure

- 1 Connect the supplied power cable to the power inlet of the printer and AC power supply outlet.

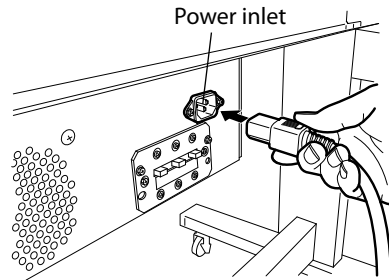

- 2 Turn on the power switch on the operation panel.

When turning on the power, the printer performs the power-on self-diagnostic test and displays the following messages on the operation panel.

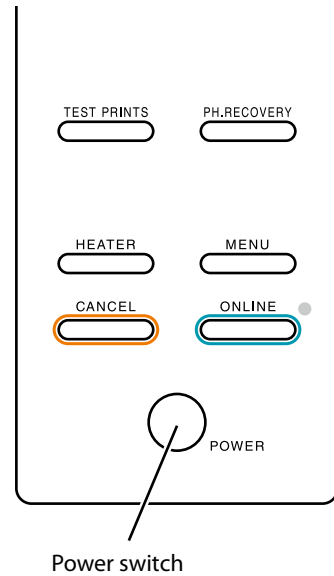
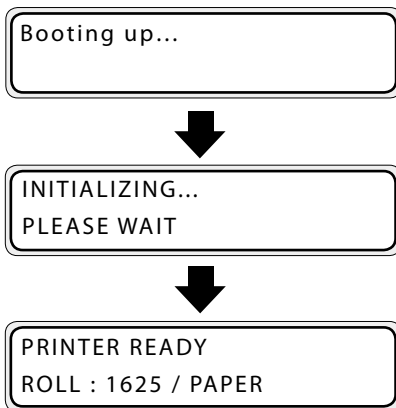

Example of the set roll media of 1625 (mm)

### Note

- When the printer is performing "INITIALIZING..." or "CLEANING", if the power is turned off unnecessarily, ink may drip or the print head may be damaged.



**HINT**

- If the LED on the operation panel does not light when the power switch on the operation panel is turned on, the power supply is defective.
- When a problem is detected in the power-on self-diagnostic test, an error message is displayed on the LCD. Refer to [Section 6 Troubleshooting], for more information.

---

**Note**

- **Do not use a power cable other than the supplied power cable for the printer.**
- **Confirm that the supplied power cable meets the requirements of AC power in your local area.**

---

## Power-off procedure

- 1 To turn off the power of the printer, keep pressing the power switch on the operation panel for 2 seconds.



SHUTTING DOWN  
PLEASE WAIT

The message shown above is displayed on the LCD to show that the shutdown process is being executed. The power is off after the shutdown is finished.

To keep the print head in good condition during shutdown, the fill cap operation (state that the cap is filled with ink) is performed. To quickly turn off the power, press the power switch while holding the **CANCEL** key to skip the fill cap operation and turn off the power. However, generally executing the fill cap operation is recommended.

---

### Note

- **After turning the power off, wait at least 5 seconds before turning it back on.**
- **To keep the print heads in good condition, the printer perform automatically and periodically the fill cap operation while in standby mode. It is recommended to keep on the power switch on the operation panel.**

# Media replacement

This section describes the **roll media installation / removal procedure**. The two situations below require roll media replacement:- When the roll media is finished, the roll media is replaced.

**- When the roll media is jammed, the roll media is replaced.**

The roll media replacement procedure for each case is shown below.

2

Basic Operation

## Roll media installation procedure

- 1 Open the front cover and slide the media edge guards to each end of the platen. Then, close the front cover.

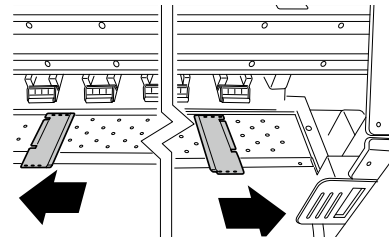

### Note

- Move the media edge guards to both ends so they cannot enter under the media.
- After completing the media replacement work, set the media guards. (☞ P.2-19 [How to use the media edge guard])
- When using media with adhesive applied to the core at the end of the roll, this adhesive may stick to the paper guide or the platen. In this case, always clean up the adhesive before using the media.



**HINT**

If a blower unit is used, move it to a place where it will not disturb the operation.

- 2 Put the left side media holder in position and fix it temporarily by turning the screw.

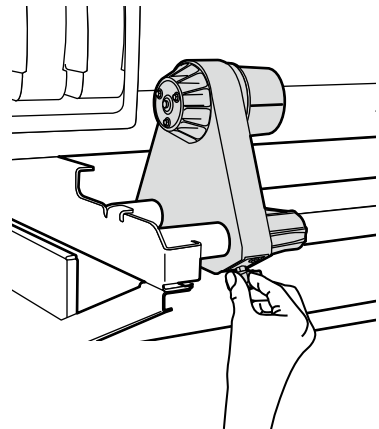

- 3** Move the right side media holder to the right end.

**Note**

- When using media with adhesive applied to the core at the end of the roll, this adhesive may stick to the paper guide or the platen. In this case, always clean up the adhesive.

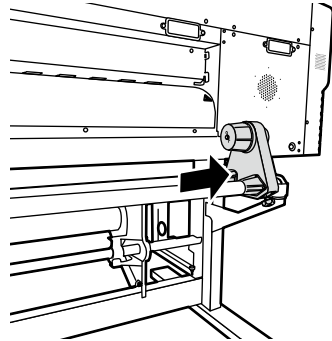

- 4** Set the roll media to the media holder fixed on the left side.

**Note**

- When inserting the roll media in the media holder, be careful not to cause the media to shift on the roll or damage the end surface of roll media.
- Make sure that the core is securely fixed to the roll holder by inserting it completely.

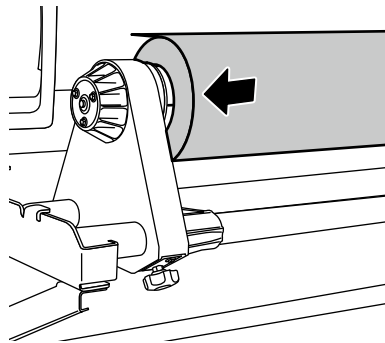

**HINT** Media setting direction

<In case of roll media with print side outside>

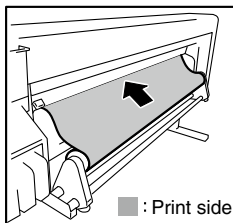

<In case of roll media with print side inside>

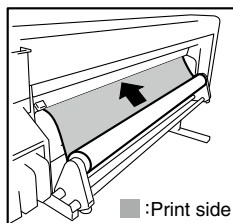

- 5** Set the roll media to the right side media holder.

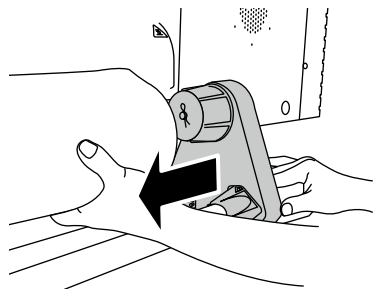



## 6 Raise the pressure roller up / down lever.

### Note

- There are three selectable positions (up, middle and down) on the pressure roller up / down lever. To raise (release) the pressure roller here, raise the pressure roller up / down lever to the top position. (☞ P.2-20 ([How to switch the pressure]))

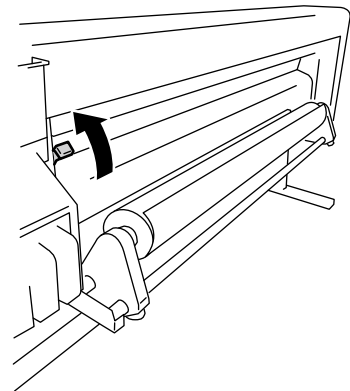

## 7 Feed the media between the pressure roller and grit roller and advance the media until the leading edge of the media comes out of the front cover.

Advance the media until the leading edge of the media comes out at a distance of 200 mm.

When the leading edge of the media comes out of the front cover, a confirmation beep sounds.

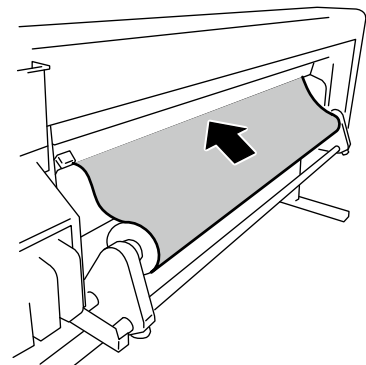

### Note

- Depending on the environment, the media may stick to the paper guide and may be hard to advance. In this case, advance the media while raising it from the paper guide by holding both edges with hands.
- If the leading edge of a media is curled up or curled down, the media may be caught in the printer or may not be properly set. If the media is curled too much, do not use it.
- Be careful that the leading edge of the media does not touch the front cover. If the roll media tends to roll, stretch it to eliminate the rolling before loading.
- Check that the media edge guard does not enter under the media.

- 
- 8** Move the media holders so that the both edges of the media are equally distributed on the pressure roller.

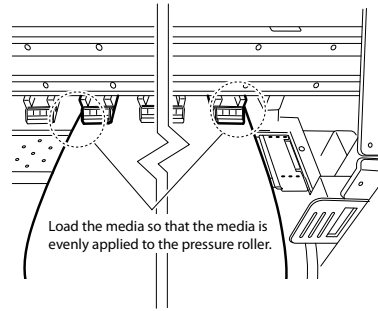

- Noting the relationship between the label gradation (indication line) and the media width will let you easily adjust the position next time you will set the media.

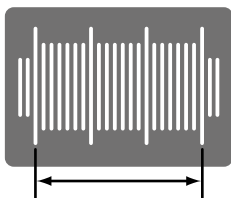

Set so that the end surface of the media comes within this range.

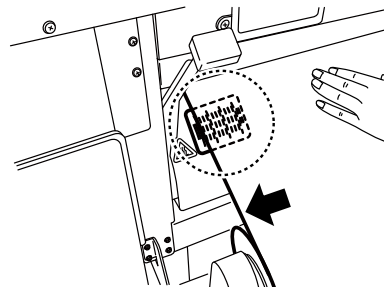

---

**Note**

- **If you shift the media only, skewing will occur. Adjust the load position by moving the media and the media holders together.**

- 9** Secure the positions of the right and left media holders by turning the screws.

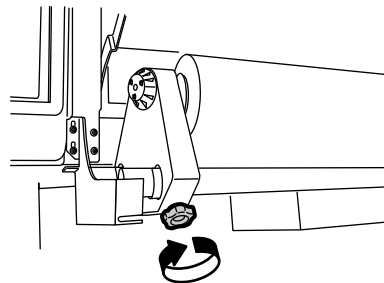

- 10** Hold the center of media with your hand and turn back the flange to eliminate the slack.

---

**Note**

- **Do not forcibly align the edge of media to the indication line. Set the media straight with regard to the roll.**

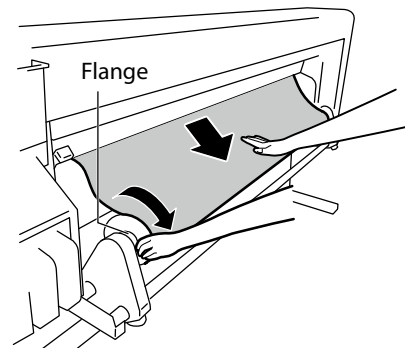

**11** Lower the pressure roller up / down lever.

After this, follow the instructions on LCD screen.

**Note**

- To lower (press) the pressure roller, lower the pressure roller up / down lever to the lowest position. (☞P.2-20 [How to switch the pressure])

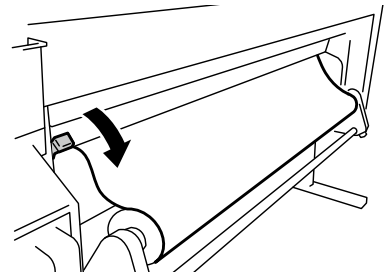
**12** Open the front cover and align the media edge guards over the both ends of the media. Then, close the front cover.

Check that the media edge guards do not go under the media and that thick media is not stuck between them.

After visually confirming that the media edge guards are properly set, press the **OK** key.



CHECK EDGE GUARD  
\*OK ?

**13** Select either the roll media or the cut media (sheet).

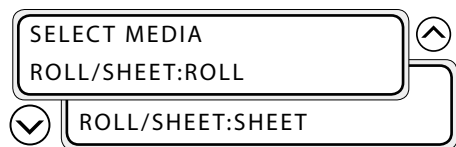
Either [roll] or [sheet] can be selected with **▲** key or **▼** key. Here, select [roll] and press the **OK** key. (To return to the media selection, press the **CANCEL** key.)



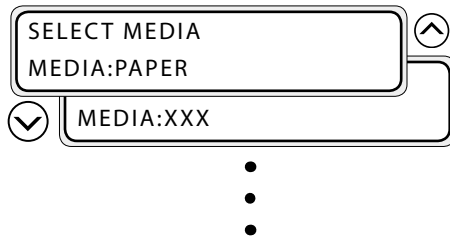

## 14 Select the type of media.

Select the type of media registered with the  and  keys and press the  key. (☞ **P.3-20 [MEDIA REG MENU]**)



### **HINT** To register a new media

[NEW MEDIA ENTRY] is displayed at the end of media registration. Press the  key to enter [MEDIA REG MENU]. The media registration procedure is the same as the registration from the registration menu. (☞ **P.3-20 [MEDIA REG MENU]**) Press  key to return from the media registration menu to the media type selection menu. To return to the value before input, press the  key.

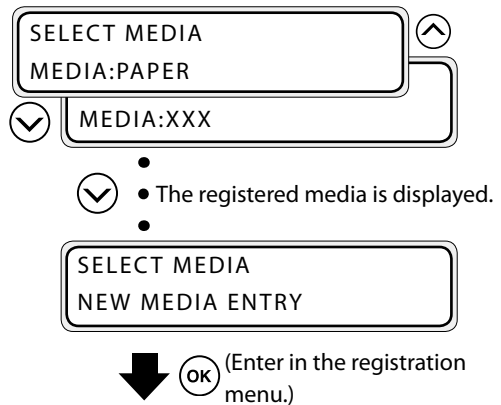

## 15 Enter the remaining length of media.

Enter the remaining length of roll media loaded to the printer. (☞ **P.3-18 [MEDIA MENU]**)



## 16 The media set operation automatically starts.



- When successfully finished, the printer returns to the online state or offline state.
- If an error occurs, an error message is displayed. Go back to step **1** and start the procedure again.

### Note

- After installing the media, check that the media does not enter in the gap of the media cutter blade or is not pinched by the media clip. Also make sure the media on the platen has no curl or wrinkles.

**Note**

- With tarpaulin and other high basis weight media, limit the media slack on the media roll side to 15 cm. The weight of the loose media may unwind the roll media.
- When rewinding more than 30 cm of the media, do not rewind it at once but execute the operation slowly while eliminating the slack by rotating the media by hand.

<Correct installation>

Make sure that the media is stretched tight as shown in the figure below  
 <In case of roll media with print side outside>      <In case of roll media with print side inside>

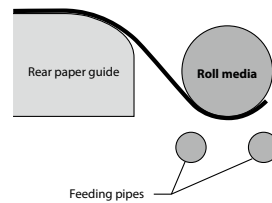
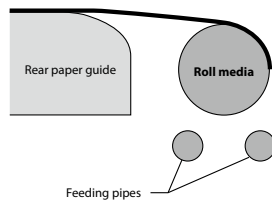
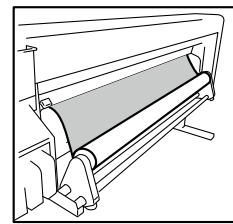
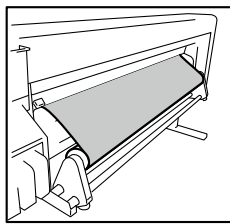

<Incorrect installation>

Eliminate the slack so that the media does not become like in the two examples below.

The figures on the upper parts are perspective views of the printer rear side. The figures on the lower parts are sectional views of the paper feed mechanism.

The slack is in gray in the perspective views and in dashed line in the sectional views.

**Example 1**

<In case of roll media with print side outside>

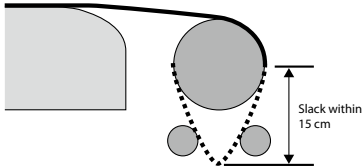
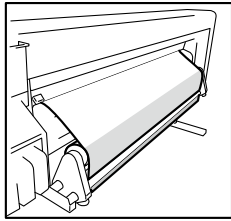

<In case of roll media with print side inside>

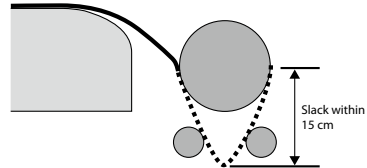
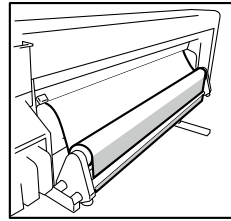

**Example 2**

<In case of roll media with print side outside>

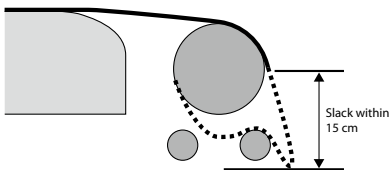
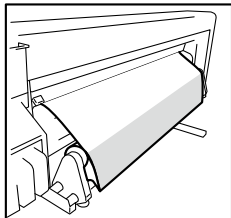

<In case of roll media with print side inside>

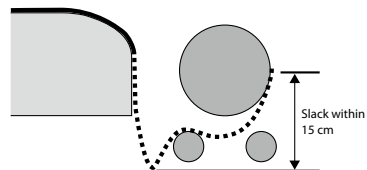
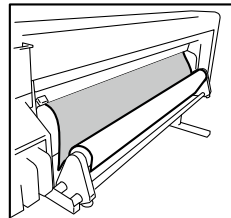

## Roll media removal procedure

- 1 Raise the pressure roller up / down lever.

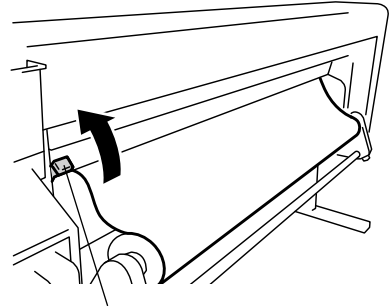

Pressure roller up / down lever

- 2 Rewind the flange to roll back the media.

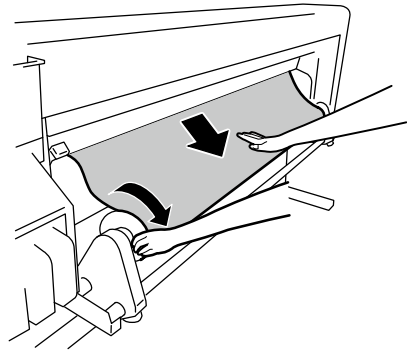

- 3 Loosen the screw of the media holder to the right, and while moving this media holder slightly to the right, remove the roll media from the media holder.

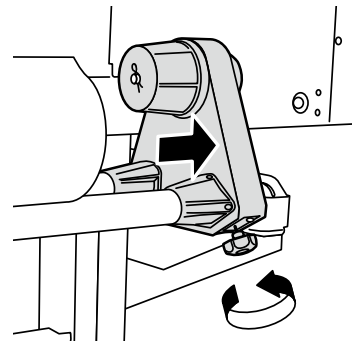

### Note

- When removing the roll media from the media holder, be careful no to let it fall as it may lead to personal injuries.

- 
- 4 Pull the roll media out of the left media holder and remove the roll media.

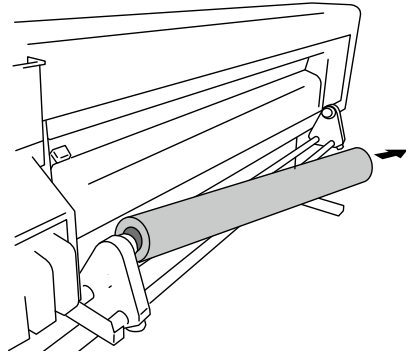

### When replacing the roll media after it runs out

When the printer runs out of media, the printer automatically detects the end and displays a message. Depending on the media's finishing (media glued to core), the printer may not automatically detect it. If printing continues in this condition, the printer may be stained or damaged. Visually check the remaining media.

- 1 The message appears on the LCD screen.

NO MEDIA LOADED  
LOAD MEDIA

- 2 Replace the media according to the media installation and media removal procedures.

### When replacing the roll media due to jamming

Refer to [Section 6 Troubleshooting (How to clear media jams)].



## Cut media installation procedure

- 1** Open the front cover and slide the media edge guards to each end of the platen. Then, close the front cover.
- 2** Raise the pressure roller up / down lever.
- 3** Advance the media until the leading edge of the media comes out of the front cover.
- 4** Move the media so that both ends of media are evenly applied to the pressure roller.
- 5** Lower the pressure roller up / down lever.  
After this, follow the instructions on LCD screen.

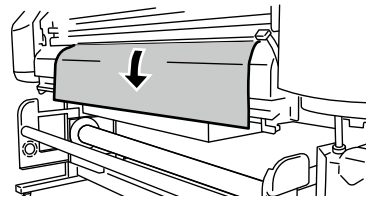

---

### Note

- Select [SHEET] for [SELECT MEDIA].
- When selecting [SHEET], the remaining media cannot be entered.

## Cut media removal procedure

- 1** Raise the pressure roller up / down lever and remove the media.

---

## When using 2 inch core rolls

2 inch core rolls can be used when the 2 inch flange option is installed. This section describe the procedure to install the 2 inch flange.

- 1 Remove the R pin from the 3 inch flange, then remove the flange.

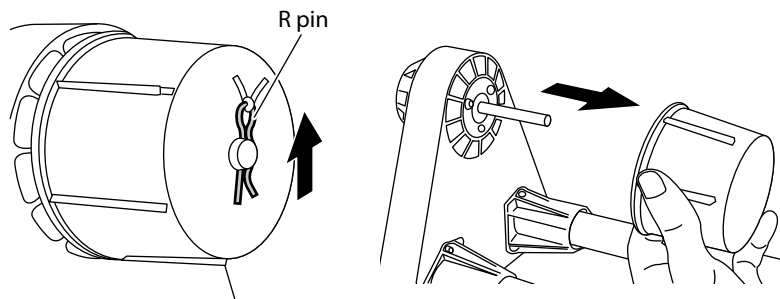

- 2 Install the 2 inch flange

---

### Note

- Make sure that the pins match the grooves.
- A new flange may be hard to insert. Make sure to insert it all the way in.
- Be careful not to lose the R pin and the pins.

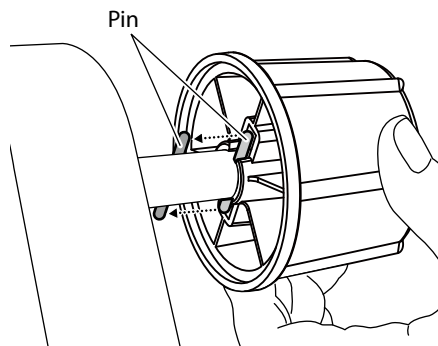

- 3 Replace the R pin.

# How to use the media edge guards

Using the media edge guards protect the print heads from media edges' curls. Slide the edges of the guards over the edges of the media.

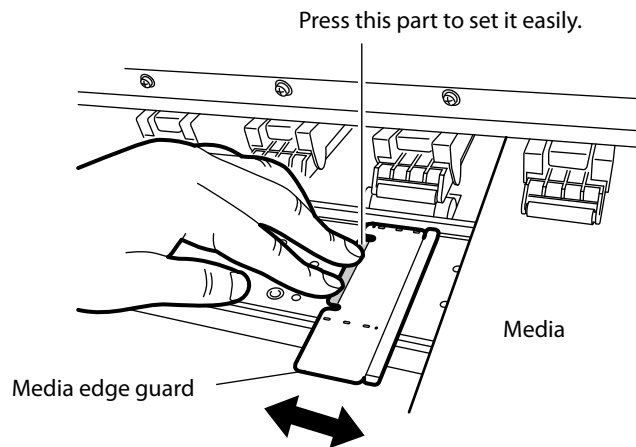

## Note

- Set "use / not-use" for media edge guard in the MEDIA REG MENU. The widths of right and left margins of the media change. (☞ P.3-29 [(8) EDGE GUARD])
- Clean the media edge guards when they get dirty.
- The media edge guards will not prevent curl effects from all media. As it causes print defects, eliminate waves and folds beforehand.
- The media edge guards cannot be used with thick media. Do not insert it forcibly.



- The right and left margins of the print area become 10 mm when using the media edge guards.

# How to switch the pressure

Switch over the pressure between the pressure roller and the grit roller used for media feeding to match different media. The bottom position is normally used. When skew occurs in the media and the media cannot be fed or when using a media with weak elasticity such as a thin cloth, switch to [weak], the center position. The pressure force is switched using the pressure roller up / down lever. (See figure below.)

[Rear]

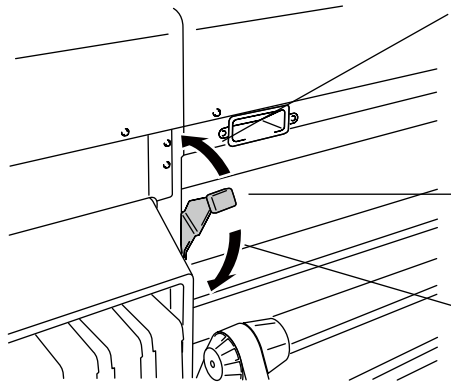

<No pressure> (top)  
When loading the media, raise the lever. This the normal UP position.

<Weak> (in the center)  
The pressure becomes weak.

<Normal Pressure> (bottom)  
When the media is loaded, lower the lever. It is the normal DOWN position.

[Front]

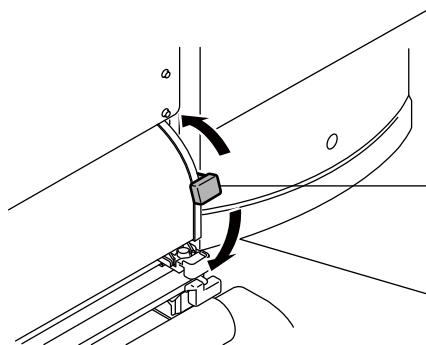

<No pressure> (top)  
When loading the media, raise the lever. This the normal UP position.

<Weak> (in the center)  
The pressure becomes weak.

<Normal Pressure> (bottom)  
When the media is loaded, lower the lever. It is the normal DOWN position.

# Feeding the media [Feed]

This function feeds the media.

- 1** Set the printer to offline.(Press **ONLINE** key.)



- 2** Press **MENU** key to move the menu group to the second layer menu and to display the FORM FEED MENU.



- 3** Keep pressing **▽** key.



While pressing **▽** key, the roll media is fed. When cut sheet media is used, the paper is ejected.

- 4** When releasing the **▽** key, feeding stops and the printer returns to the of-line state (menu mode).



**HINT** - When the online state (idle mode) is displayed, if **▽** key is pressed, the media can be fed without entering the FORM FEED MENU.

# Rewind the media [Back Feed]

This function rewinds the media.

## 1 Set the printer to offline.

(Press **ONLINE** key.)

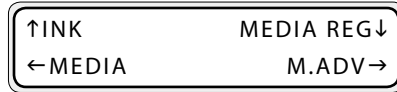

## 2 To display the [REWIND] menu, press

**MENU** key.



## 3 Keep pressing **⏮** key.

While pressing **⏮** key, the roll media is fed back. When the cut media is used, the paper is ejected.



## 4 When releasing the **⏮** key, rewinding stops and the printer returns to the offline state (menu mode).



### HINT

- A paper ejection sensor that detects the media is installed to the front paper guide. If the media covers the paper ejection sensor, the media can be fed back. When you keep pressing **⏮** key, the media can be fed back at a maximum distance of 14 cm from the paper ejection sensor.
- When the online state (idle mode) is displayed, if **⏮** key is pressed, the media can be fed back without entering in the REWIND MENU.

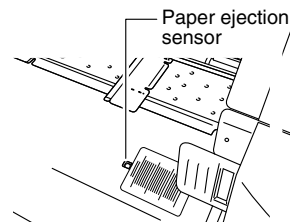

### Note

- When rewinding high basis weight media, the weight of the loose media may unwind the roll media. (For details, P.2-13, P.2-14)

# How to use the origin setting function

## <Origin setting function>

When a small image is printed on, for example, a "64" width media, a large margin is created as shown below.

By returning the printed media and re-setting the origin of print start, another image may be printed in this margin. Re-setting the origin of print is called [Origin setting function].

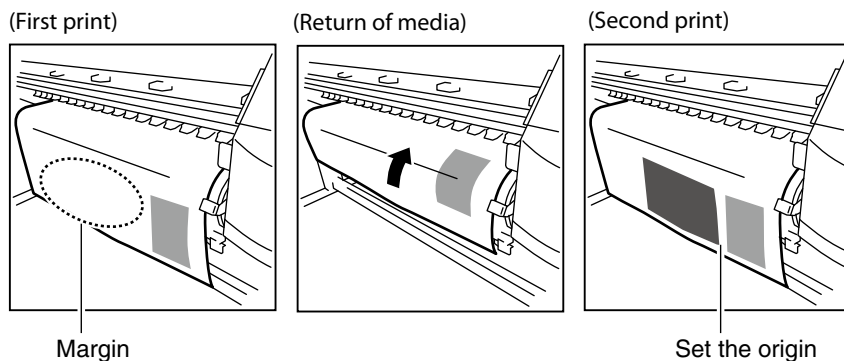



## <Procedure to use the origin setting function>

- 1 Return the media by operating [Back Feed].  
(☞ P.2-22 Rewind the media [Back Feed])

### Note

- Return the media only after the printed image completely dries. The first printed image will be damaged if this function is used before it is sufficiently dry.

- 2 Press and hold the  key for 1.5 seconds in the online state (idle mode) to move the carriage and enable the origin setting.

Align the  label on the carriage front with the origin.

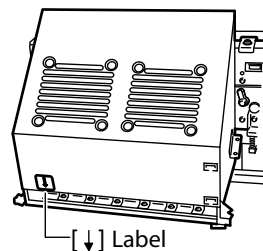

- 
- 3** When [NEST ORIGIN SETTING] is displayed, move the carriage to the desired position as the origin with ◀ and ▶ keys.

NEST ORIGIN SETTING  
CARRIAGE MOVING

- 4** Press **OK** key to confirm the origin setting. The carriage returns and the printer becomes ready to print (online state (idle mode) display).

NEST ORIGIN SETTING  
\*OK ?



NEST ORIGIN SETTING  
PLEASE WAIT



PRINTER READY  
NEST:1625/PAPER

To cancel the set origin, press and hold the ▶ key for 1.5 seconds in the idle mode, or raise the pressure roller up / down lever. When canceled, the display returns from [NEST] to [ROLL] or [SHEET].

<Display when canceled>

PRINTER READY  
ROLL : 1625 / PAPER



# Changing temperature using the heater control menu

The heater initial value that is set in MEDIA REG MENU is automatically set for the temperature of each heater. Therefore, the heater control menu is generally not needed. The heater control menu is used to fine-adjust the heater temperature during printing or to monitor the current heater temperature.

## ■ Heater control menu display

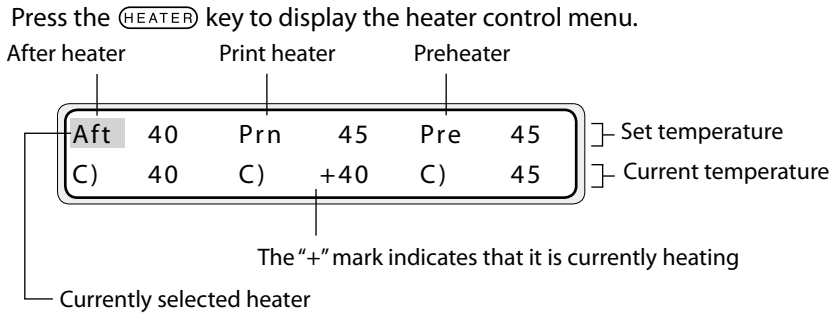

## ■ Key operation in the heater control menu

<b>←</b> and <b>→</b> keys	Select a heater for which temperature is to be set.
<b>↑</b> and <b>↓</b> keys	Set the heater temperature.
<b>MENU</b> key	Selects heater ON or OFF.
<b>OK</b> key	When this key is pressed for 1.5 seconds while the heater control menu is displayed, all the heaters are forcibly activated and left ON even without print operation (heating control is activated). However, the heaters turn OFF automatically if no print operation is done for a while.
<b>CANCEL</b> key	Pressing this key for 1.5 seconds with the heater control menu displayed cancels the heater-on state made forcibly by the <b>OK</b> key. (The heater-on state is canceled and the printer returns to the normal control following delay time and standby time settings.)

## ■ To finish displaying the heater control menu

Press the **HEATER** key while the heater control menu is displayed.



- When no key is pressed for more than 30 seconds with the heater control menu displayed, [HEATER DISPLAY END] is automatically displayed and the heater control menu display is closed.
- Even if heater temperatures are changed in the heater control menu, the initial temperature value of each heater stored in MEDIA REG MENU remains unchanged.
- When the temperature unit in SETUP MENU is set to Fahrenheit, every temperature is displayed in Fahrenheit.

---

## ■ Reference information on media types and heater settings

The heater set temperatures and reference set values (initial values) of print mode for each type of media are shown in the table below. Change the settings according to the media in use.

Media type	Media selection	Recommended heater temperature setting			Print mode
		After heater	Print heater	Preheater	
Glossy vinyl chloride	Glossy	45°C	40°C	45°C	Normal, bidirectional
Matte vinyl chloride	Matte	45°C	40°C	45°C	Normal, bidirectional
Tarpaulin	Banner	45°C	40°C	45°C	Normal, bidirectional

It is recommended that temperature of the after heater, print heater, and preheater be set to less than 50°C, 45°C, and 50°C respectively.

---

### Note

- **Setting a high temperature for the print heater makes ink fusion better, but may cause wrinkles in the media or make the print surface matte. Adjust the heater temperature according to the media type and ambient temperature.**
- **When the print heater is set to a high temperature, the printer lowers the printing speed automatically in some cases to maintain stable print quality.**
- **Set the preheater and after heater temperatures so that they are nearly 5°C higher than the print heater temperature. Bad temperature balance between preheater/after heater and print heater may cause wrinkles in the media.**
- **Setting a high temperature for the print heater may cause print defects.**

## ■ Heater temperature setting procedure

(1) When a media type is selected when setting a media, initial temperature values of each heater for the selected media type are displayed on the menu.

(☞ **P.3-31 [(14) AFTER HEATER T], [(15) PRINT HEATER T], [(16) PREHEATER T]**)

- When the initial temperature value is set, the heater is turned on.  
(Heating does not start until print starts.)
- When the initial temperature value is set to [\*\*], the heater is turned off.  
(The heater set temperature is not displayed.)

- (2) When print data is received from the computer, either of the following is performed before printing.
- If [HEATER PREF] is set to [SOFTWARE] in the MEDIA menu (☞P.3-34 [(22) HEATER PREF]
    - The set temperature on the heater control menu is overwritten by the temperature that is set by the RIP (print data, job), and heating starts.
    - When no temperature is set by the RIP (print data, job), heating starts with the set temperature on the heater control menu.
  - If [HEATER PREF] is set to [HEAT PANEL] in the MEDIA menu (☞P.3-34 [(22) HEATER PREF]
    - The temperature set by the RIP is ignored and heating starts with the temperature set on the operation panel.
- (3) When the current temperatures of the after heater, print heater, and preheater reach temperatures that are 1°C lower than the set temperatures, the printer starts printing.
- When the current temperature is higher than the set temperature, the printer starts printing before the temperature lowers. Temperature control is performed continuously after printing starts to maintain the heaters to their set temperatures.
- (4) The heater temperature can vary during printing by changing the set temperature in the heater control menu. Even after printing is completed, the set temperature changed in the heater control menu remains as "set temperature." However, the initial temperature value of each heater stored in MEDIA REG MENU remains unchanged.
- (5) The subsequent printing returns to (2).



## HINT

- The three heaters work in the state displayed on the LCD regardless of the means used to set their temperatures.
- The following figure shows the heater temperature control system for printing. The delay time and standby time can be changed with the heater menu in the offline mode. (☞P.3-62 [Heater menu])
- The standby set temperature is fixed at 35°C.

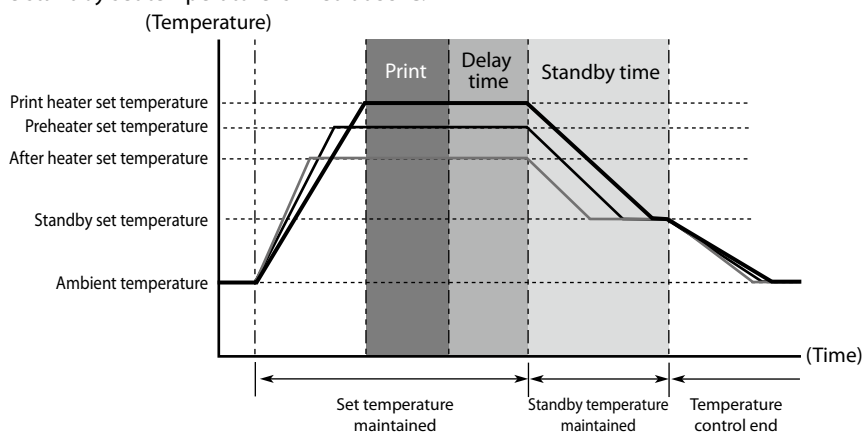

# Change the Print head height

Switch the print head height to match the thickness of the media.  
To switch the height of print head, use the head up down mechanism.

- 1** Set the printer to offline.

(Press **ONLINE** key.)



- 2** Press **MENU** key to display PH.MAIN MENU.



- 3** Press **➤** key and then **✓** key to display [PH HEIGHT ADJ].



- 4** Press **OK** key.



- 5** Open the front cover and the maintenance cover and loosen the two (2) head securing screws.

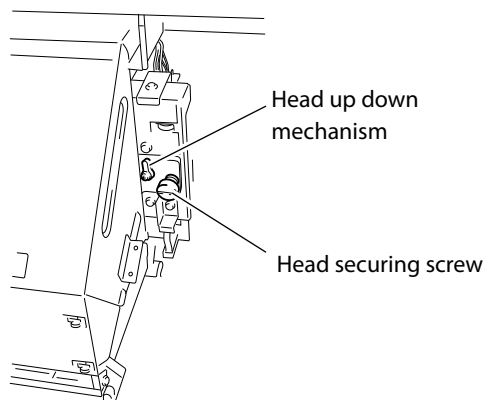
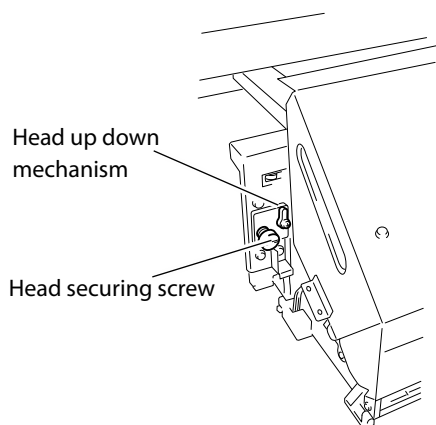

## 6 Switch the height of print head with the head up down mechanism.

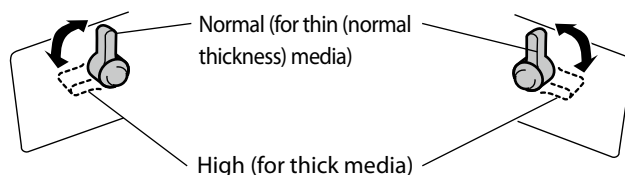

**HINT**

◇ [High] is 0.5 mm higher than [Normal].

Generally, [Normal] is used for glossy and matte vinyl chloride, and [High] is used for tarpaulin and FF. If the media thickness exceeds 0.5 mm, [High] should be used regardless of the media type. Use also [High] even with thin media if it is severely wrinkled or contains irregularities that may touch the print head.

## 7 Tighten the two (2) fixing screws.

### Note

- Do not move the head up down mechanism with the head securing screws tightened. The head up down mechanism may be broken.
- When changing the height of the print head, tighten the head securing screws while pushing lightly the carriage downward.
- When changing the height of the print head, change [PH HEIGHT VAL] in the MEDIA REG MENU also. (☞ P.3-32 [(18) PH HEIGHT VAL])
- A print shift may occur during bi-directional printing after changing the height of the print head. In this case, adjust the bidirectional position in [BIDIR ADJ] of the MEDIA REG MENU. (☞ P.3-35 [(27) BIDIR ADJ1 L] to [(32) BIDIR ADJ3 R])
- As the gap between the side plate of the printer and the carriage is narrow, if it is hard to reach the head up down mechanism and head securing screws, move the carriage to the right (or the left) with your hands.
- Confirm that the right and left head securing screws are tightened. If carriage moves with the head securing screws loosened, they may strike the media or edge guard, causing poor image quality and damage to the printer.
- Always operate the two head up down mechanisms at the same time and be sure that they are set to the same position.



**HINT**

- During adjustment of the head height, the warning beep will be heard. (☞ P.3-58 [(5) BEEP])

# Ink cartridge replacement

This section describes the ink cartridge replacement procedure.

Replace (or remove and insert again) the ink cartridges in the following cases:

- When the ink cartridge is empty and the ink cartridge needs to be replaced
- When no ink cartridge is installed
- When the ink cartridge is not recognized
- When ink cartridges with a large amount of ink are needed for lengthy printing or similar operation

## Note

- **Do not remove the ink cartridge until the ink is used up unless it is absolutely necessary. The ink may leak if the cartridge is removed and reinserted many times.**
- **Ink cartridges can be removed while printing if the print operation has been suspended. Remove ink cartridges during printing only when PRINTER PAUSED is displayed on the operation panel.**
- **Do not touch the green board (IC chip) of ink cartridges.**
- **If, after replacing an ink cartridge, print defects occur in the color of the replaced cartridge, perform the cleaning (normal) after plugging the cartridge in and out 2 or 3 times. (☞ P.4-24)**

## Ink cartridge replacement procedure

- 1** Pull the ink cartridge out of the printer.

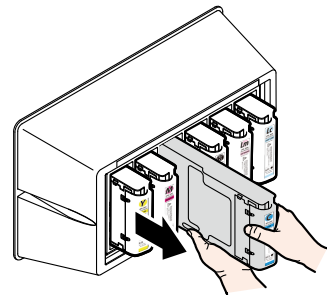

- 2** Insert the new ink cartridge in the correct color slot.

Insert the ink cartridge as far as it goes. The location of ink cartridge installation is determined by its color. (☞ P.1-14 [Ink])

Do not attempt to forcibly insert an ink cartridge in the slot of a different color.

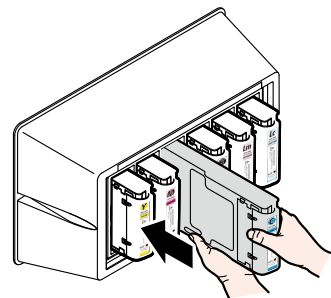

- 3** The replacement is finished.

- When successfully finished, the printer returns to the online state or offline state.
- If an error occurs, an error message is displayed. Go back to step **1** and start the procedure again.

## When the ink cartridge is empty and it needs to be replaced

- 1 The following message is displayed.

REPLACE  
XX INK CARTRIDGE

XX : Ink name  
K : Black                      Lm: Light magenta  
Lc : Light cyan              C : Cyan  
M : Magenta                  Y : Yellow  
Ny: Neon yellow              Np: Neon pink

- 2 Replace the ink cartridge following the ink cartridge replacement procedure.

## When no ink cartridge is installed

- 1 The following message is displayed.

INSTALL  
XX INK CARTRIDGE

XX : Ink name  
K : Black                      Lm: Light magenta  
Lc : Light cyan              C : Cyan  
M : Magenta                  Y : Yellow  
Ny: Neon yellow              Np: Neon pink

- 2 Install the ink cartridge following the ink cartridge replacement procedure.

## When the ink cartridge is not recognized

- 1 The following message is displayed.

CHECK nn  
XX INK CARTRIDGE

XX : Ink name  
K : Black                      Lm: Light magenta  
Lc : Light cyan              C : Cyan  
M : Magenta                  Y : Yellow  
Ny: Neon yellow              Np: Neon pink  
nn : Error code

- 2 Re-install the ink cartridge following the ink cartridge replacement procedure.

### Note

- **A ink cartridge that cannot be recognized cannot be used.**
- **If the message appears again after re-installing the ink cartridge, contact your dealer or a service representative.**

# Reloadable cartridge replacement

This section describes the reloadable cartridge replacement procedure.

## Consumables

For details about reloadable cartridge names and types,  [Appendix 3 Options / Consumables].

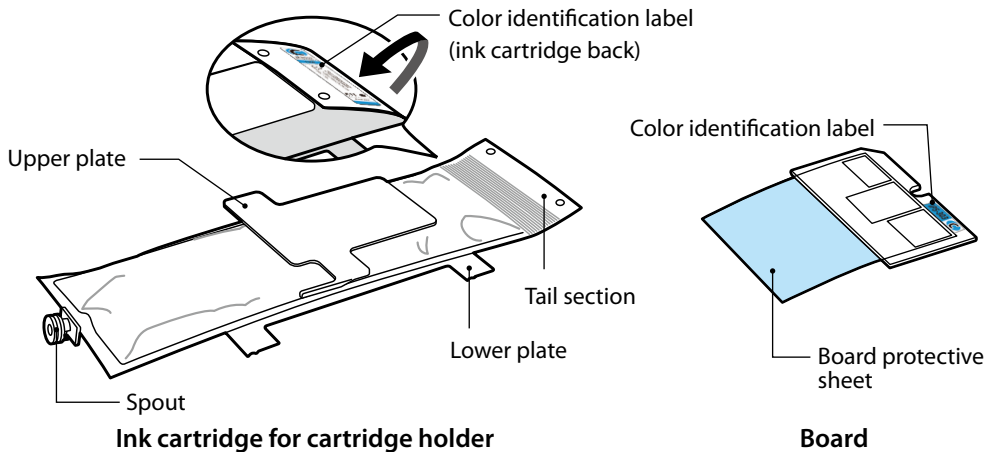

## Cartridge assembly

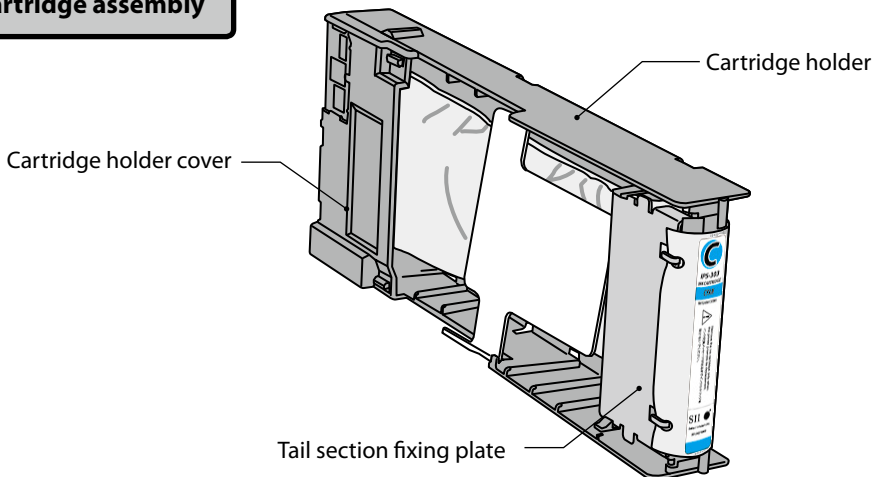

### Note

- Check that the colors and types indicated on the ink cartridge tail section's color identification label and the board's color identification label are the same.
- Usually a small quantity of ink remains in the used ink cartridge removed from the cartridge holder. This is normal.
- Always replace the board together with the used ink cartridge.
- Once an ink cartridge has been set to a cartridge holder, do not remove it until the ink has been entirely used. If a cartridge that still contains ink is removed and inserted again, ink end may not be detected correctly.
- To temporarily put aside an ink cartridge that still contains ink, store it using



the cartridge holder IP5-320 (sold separately) without removing it from the holder.

### Used ink cartridge removal procedure

- 1** Pull the used ink cartridge, together with the cartridge holder, out of the printer.

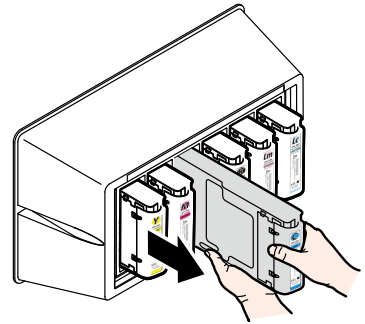

- 2** Remove the cartridge holder cover.

While keeping the two cover securing claws open by moving them to the outside (arrows (1) direction), pull the cartridge holder cover toward the top (arrow (2) direction).

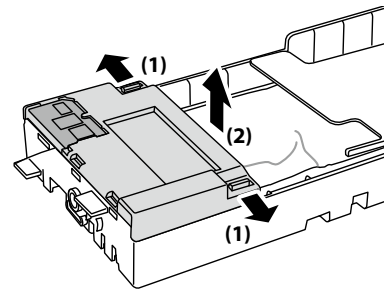

Remove the cartridge holder cover in the arrow (3) direction.

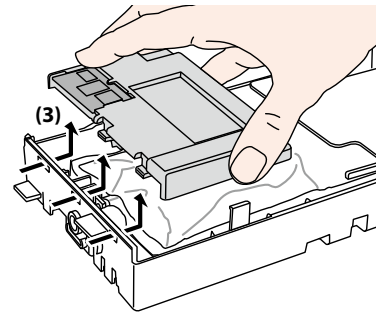

- 3** Remove the board from the cartridge holder cover.

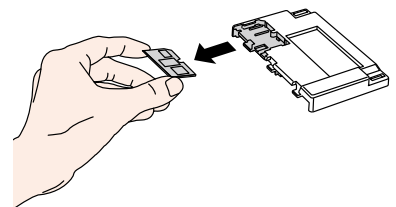

- 4** Remove the tail section fixing plate.

While keeping the two claws securing the plate open by moving them to the outside, pull the tail section fixing plate toward the top.

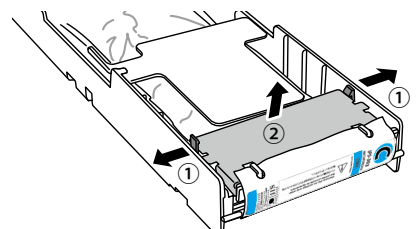

- 
- 5** Remove the used ink cartridge tail section from the tail section fixing plate.

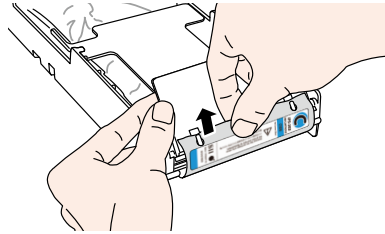

- 6** Remove the used ink cartridge spout from the cartridge holder.

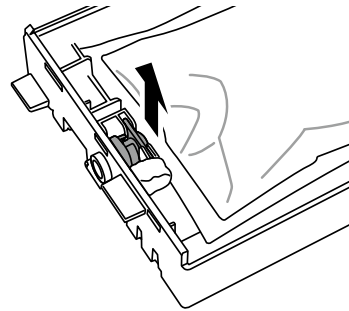

- 7** Referring to the locations on the cartridge holder shown in the figure, slide the four protrusions of the ink cartridge lower plate in the arrow direction, and remove the ink cartridge from the cartridge holder.

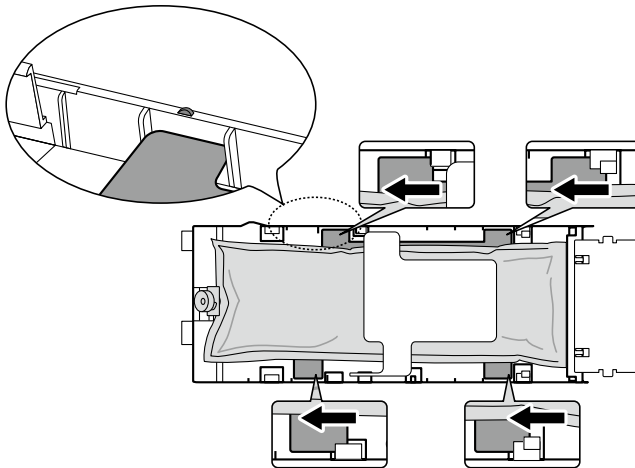

---

**Note**

- Be careful not to take the silver plate off the cartridge holder when removing the used ink cartridge.

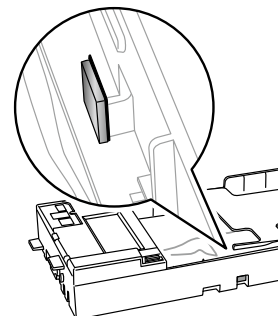

**Ink cartridge installation procedure**

**1** Make sure that the ink cartridge upper plate is face up, and insert the tail section in the hole shown in white in the figure to the right.

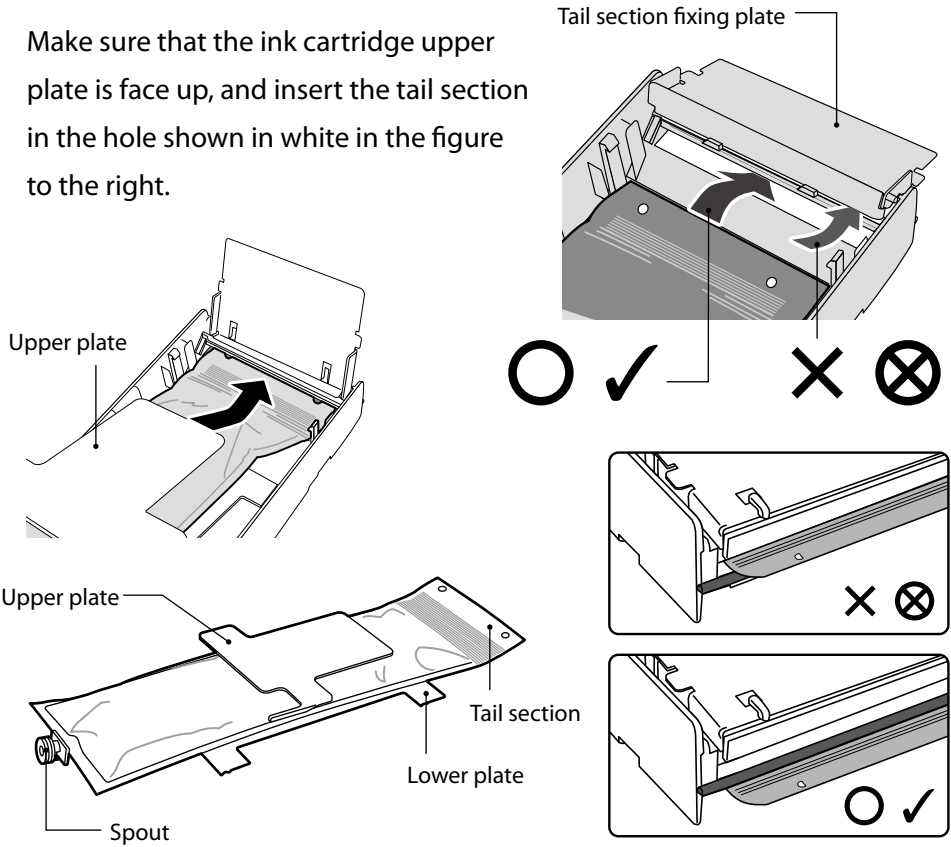

**Note**

- Do not hold the ink cartridge by the upper plate only, as it may be taken off. Hold the cartridge by both the upper and lower plates or from the bottom to insert it.

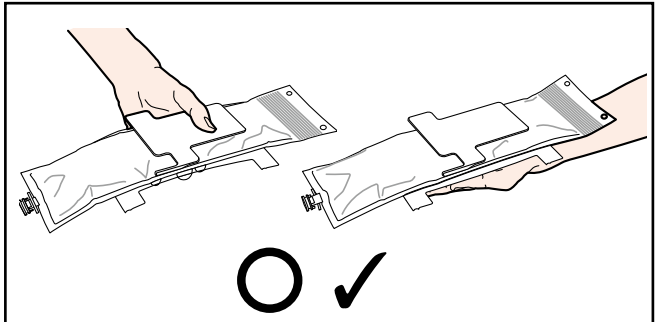
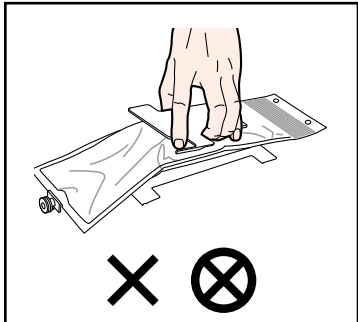

- 
- 2** Referring to the locations on the cartridge holder shown in the figure, insert the four protrusions of the ink cartridge lower plate and slide them under the plate guide following the arrow direction.

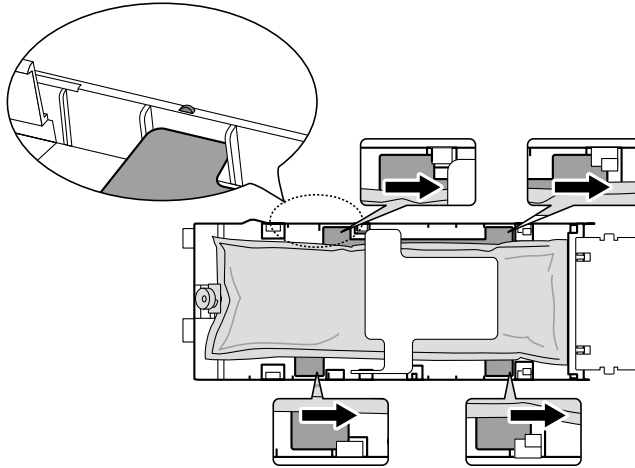

- 3** Insert the ink cartridge spout in the cartridge holder.

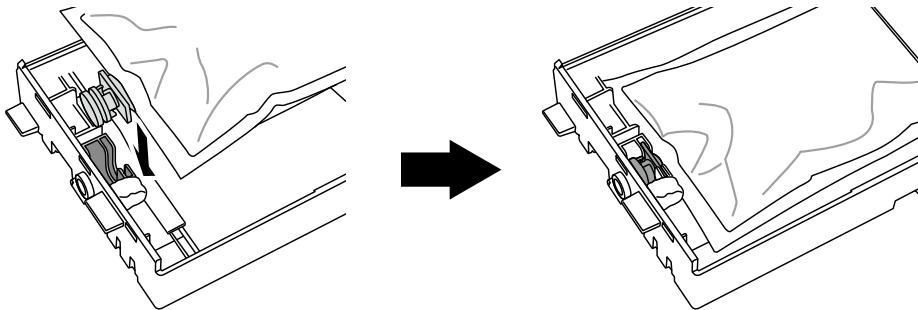

---

**Note**

- Do not install the ink cartridge with the spout tilted.

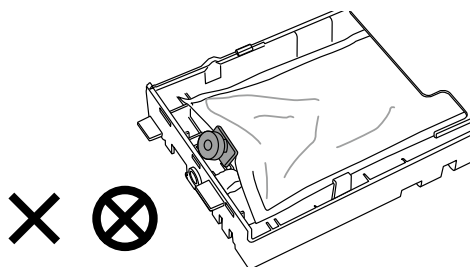

**4** Insert the board in the cartridge holder cover.

With the golden surface of the board facing up, insert it so that the board shape matches the shape of the cartridge holder cover.

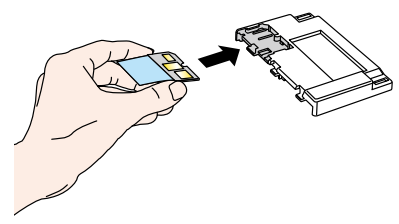

**Note**

- Do not take the board protective sheet off until you install the reloadable cartridge to the printer. This sheet prevents contact failure.

**5** Pull softly the tail section of the ink cartridge.

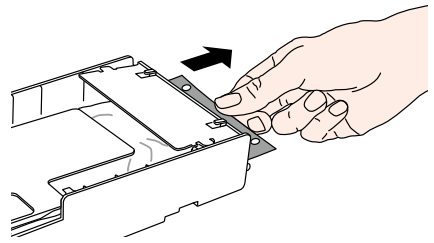

**6** Install the cartridge holder cover.

Insert the three protrusions of the cartridge holder cover in the cartridge holder holes. Hook the cartridge holder cover to the claws to secure it.

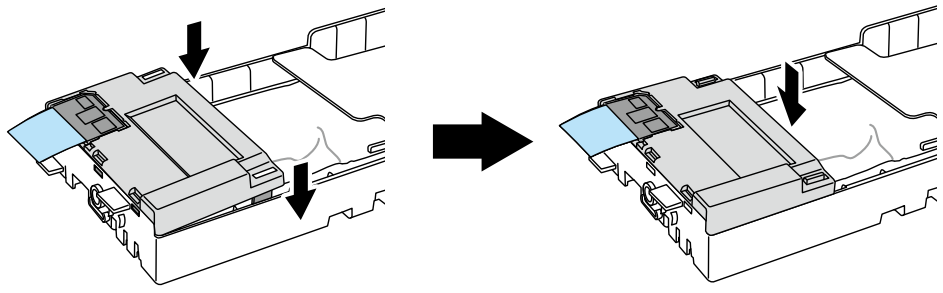
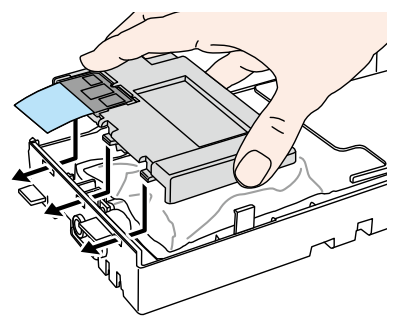

**Note**

- Make sure that the board protective sheet does not get between the cartridge holder and the cartridge holder cover.

- 
- 7** Insert the tail section fixing plate hooks into the ink cartridge tail section holes to attach it.

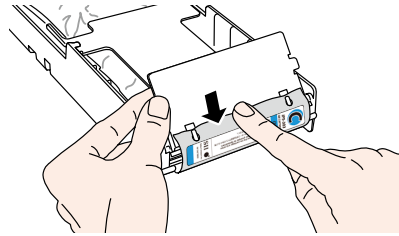

---

**Note**

- Do not apply an excessive force as the ink cartridge holes may be deformed.

- 8** Hook the tail section fixing plate to the cartridge holder claws.

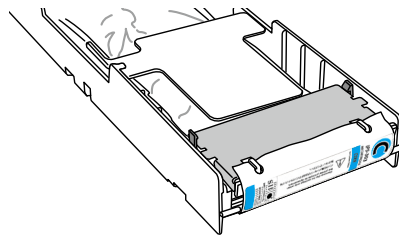
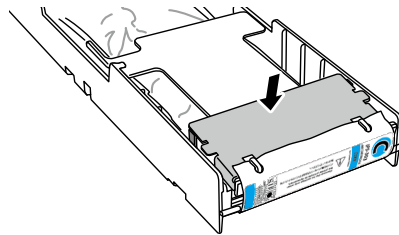

- 9** Remove the board protective sheet.

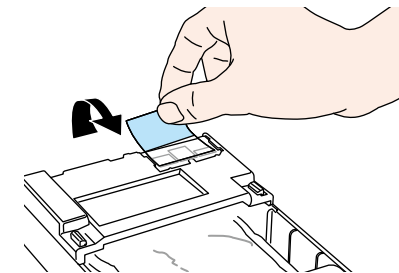

---

**Note**

- Be sure to remove the board protective sheet. Installing the ink cartridge to the printer without removing the board protective sheet may cause a malfunction.

- 
- 10** Insert the reloadable ink cartridge into the slot.

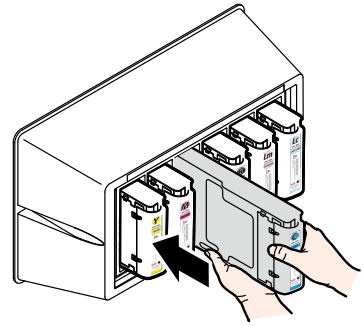

---

**Note**

- Check that the color on the ink cartridge tail section label and the color on the ink box label are the same.
- Do not push strongly the tail section fixing plate toward the inside.
- The Ny (neon yellow) cartridge must be inserted in the slot with the Lc label, and the Np (neon pink) cartridge in the slot with the Lm label.

# Waste ink bottle replacement

This section explains the waste ink bottle replacement procedure. There are two situations that require the waste ink bottle replacement procedure:

- When no waste ink bottle is installed
- When the waste ink bottle is full

The procedure for each case is described below.

## Note

- Do not replace the waste ink bottle during printer operation.
- When replacing the bottle, use caution not to spill the ink. Use protective paper to prevent soiling.

## Waste ink bottle replacement procedure

- 1** Remove the bottle from the waste ink spout (tube) by slightly tilting the full waste ink bottle.
- 2** Put the cap on the bottle and remove the bottle.
- 3** Wipe off any ink stains around the waste ink bottle.
- 4** Install a new (empty) waste ink bottle.

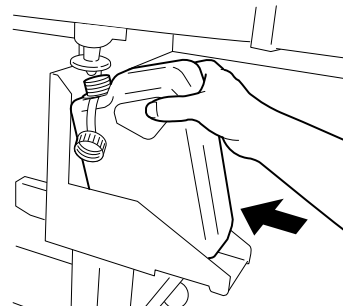
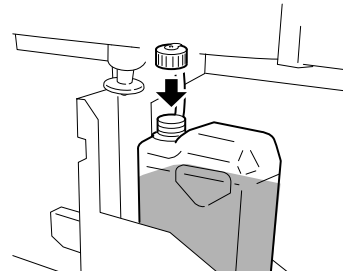
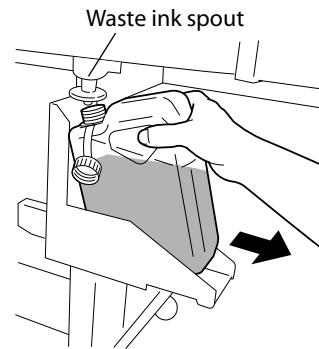



---

**5** The following message is displayed to reset (clear) the waste ink counter.

#BOTTLE EMPTY?  
\*NO

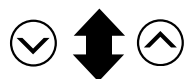

#BOTTLE EMPTY?  
\*YES

---

**Note**

- **The printer automatically calculates waste ink with a counter and displays the message prompting replacement of the waste ink bottle when the waste ink bottle is full. As there is no sensor for the waste ink level, this calculation is just an estimate. Therefore, if the waste ink counter is reset (set to \*YES) and the bottle is not empty, the waste ink may overflow.)**

**6** Select "BOTTLE EMPTY? \*YES" and press  key.

---

## When no waste ink bottle is installed

- 1** The following message is displayed.

BOTTLE OUT  
INSTALL BOTTLE

- 2** Install a waste ink bottle. Refer to  **P.2-40 [Waste ink bottle replacement]** steps **1** to **4**.

- 3** The following message is displayed to reset (clear) the waste ink counter.

#BOTTLE EMPTY?  
\*NO

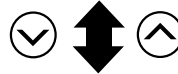

#BOTTLE EMPTY?  
\*YES

- 4** Select "BOTTLE EMPTY? \*YES" and press  key.

---

### Note

- Select **YES** when installing a new (empty) waste ink bottle.
- If the waste ink bottle is removed only to visually check the level in the waste ink bottle, select **\*NO**.

# The media was skewed.

The printer checks for media skew when the printing starts and at every three meters of print (\*). If the printer detects the skew level is larger than specified, the print operation is suspended and an operation panel message appears so that you can select to continue or cancel the print.

(\* When [SKEW CHECK] in [MEDIA REG MENU] is set to ON.)

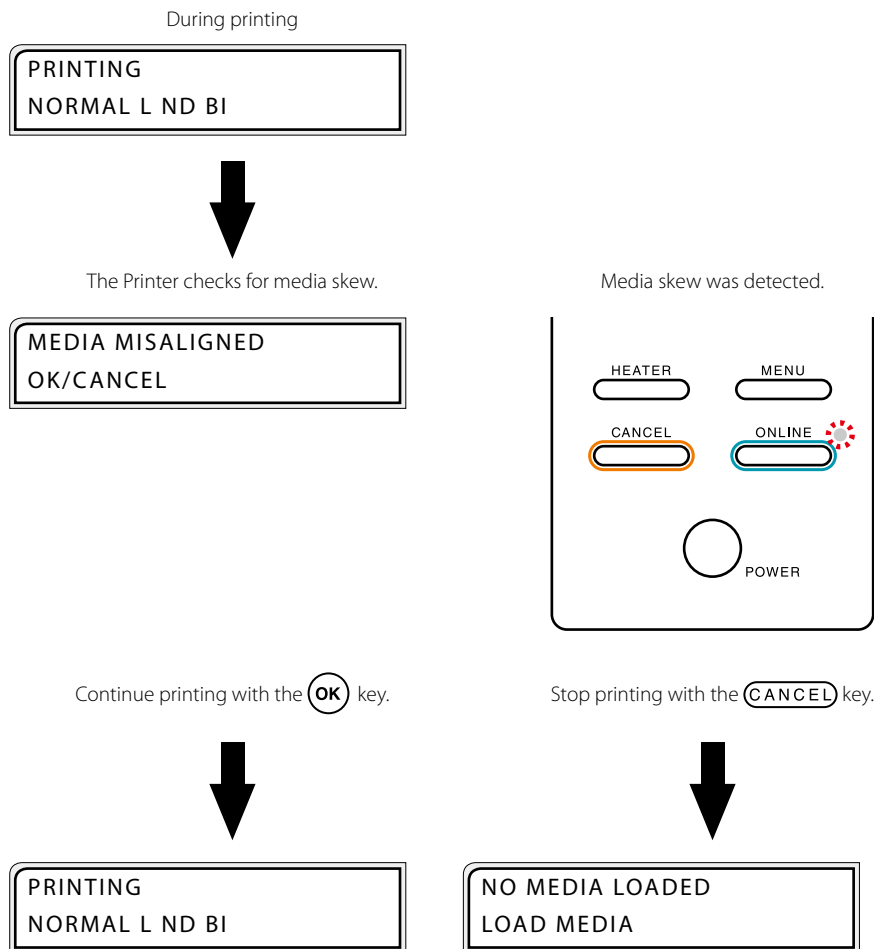

**HINT**

**[CANCEL]** is recommended.

- If you select **[OK]** to continue the print, the rest of the suspended printing job is started. However, the media may be disengaged from the media edge guards, or the media may be jammed. When the printout is lengthy, the skew may be worse, which may damage the Printer.



# 3

## *Menu of Operation panel*



This section explains the basic operations and structure of the operation panel menu, and the operations in each menu.

---

(Content of this section)

Basic menu operation in offline mode ..... 3-2

Explanation of each menu operation ..... 3-17

# Basic menu operation in offline mode

Press **ONLINE** key while the printer is in idle mode (online status) to put the printer in offline mode, display the menu on the LCD and enable menu operations.

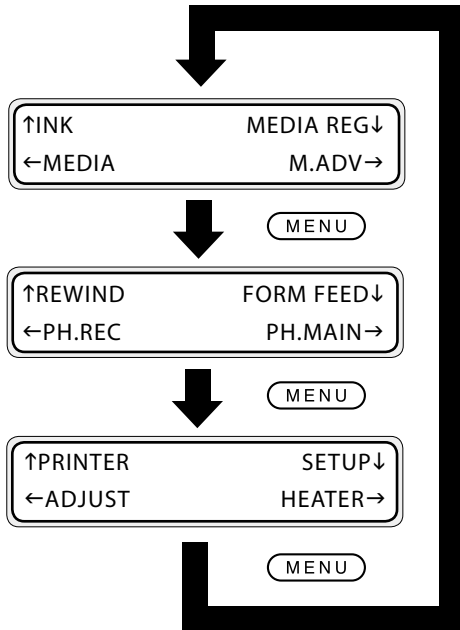

## Note

- If **ONLINE** key is pressed, the printer goes into offline state, even if an error message is displayed. However, depending on the error type and the solution being processed, the offline state may not be available. In this case, solve the error before going to the offline state.

---

## Menu layer structure

The menu consists of the following layers.

### <First layer menu>

This is the menu group displayed first. Several menus may exist on the lower layer.

### <Second layer menu>

This menu group is under the first layer.

### <Third layer menu>

This menu group is under the second layer.

### <Parameter>

This selection is used to select or enter items of the selected menu. Inputs include numerical values, characters, selection and execution.

## Menu tree

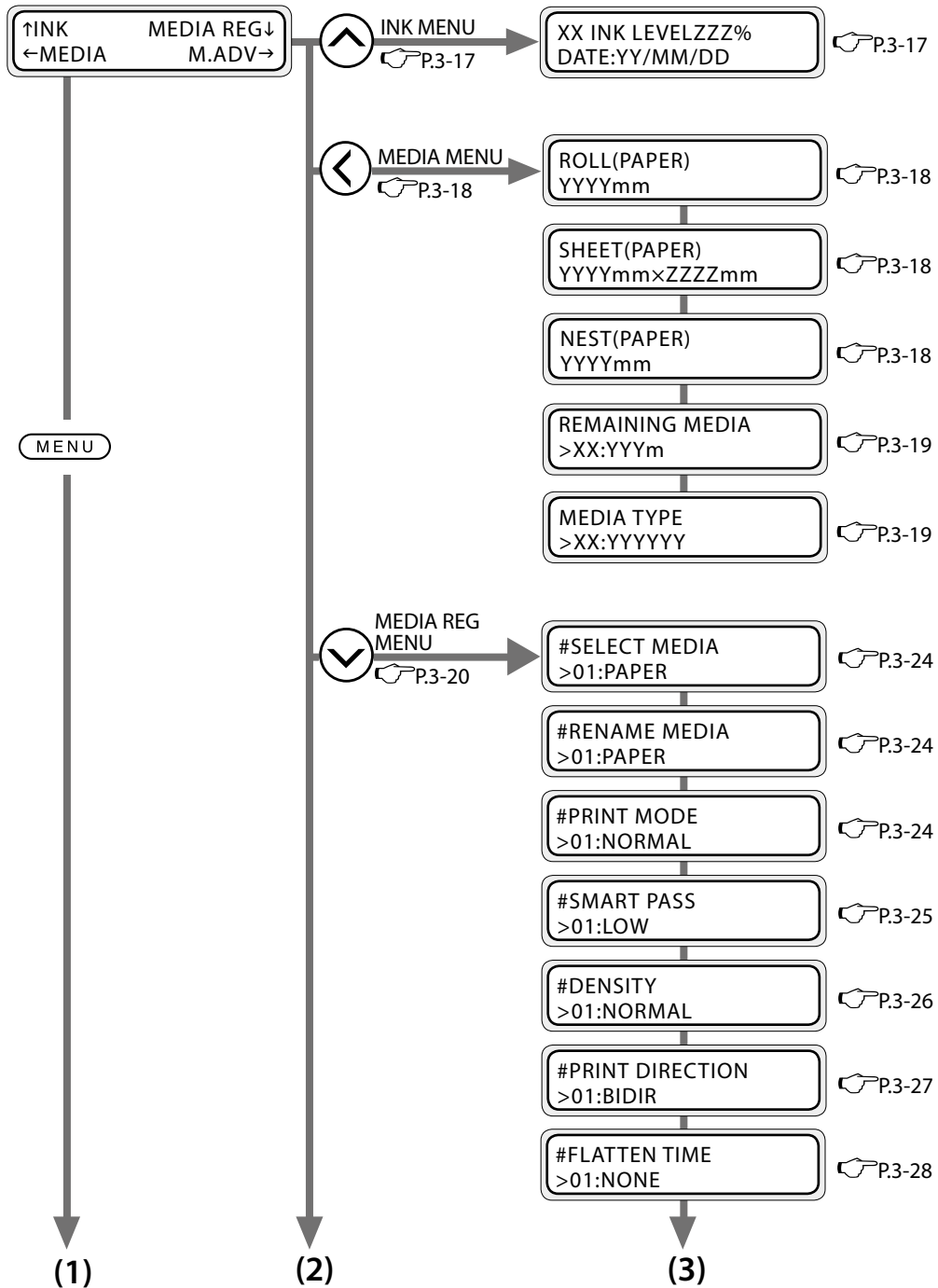



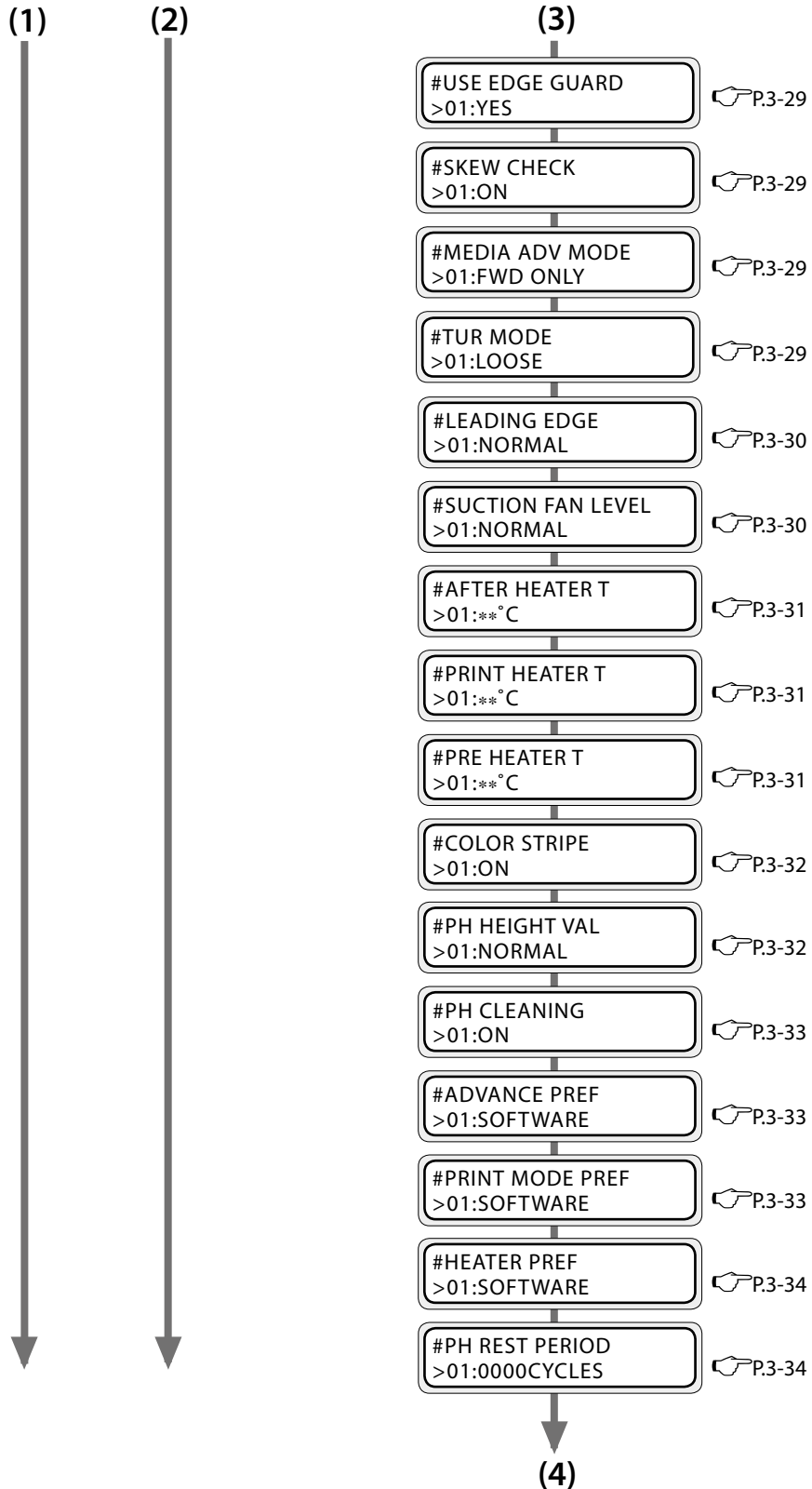

(1)

(2)

(4)

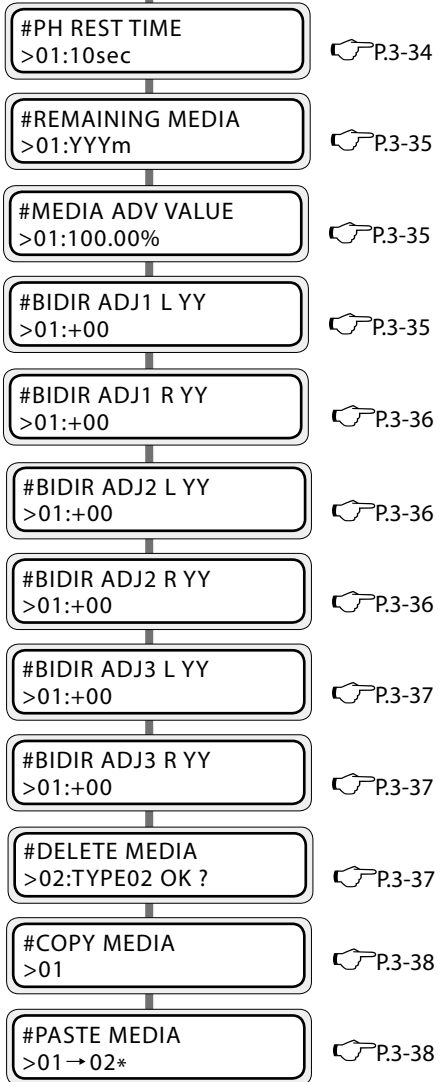

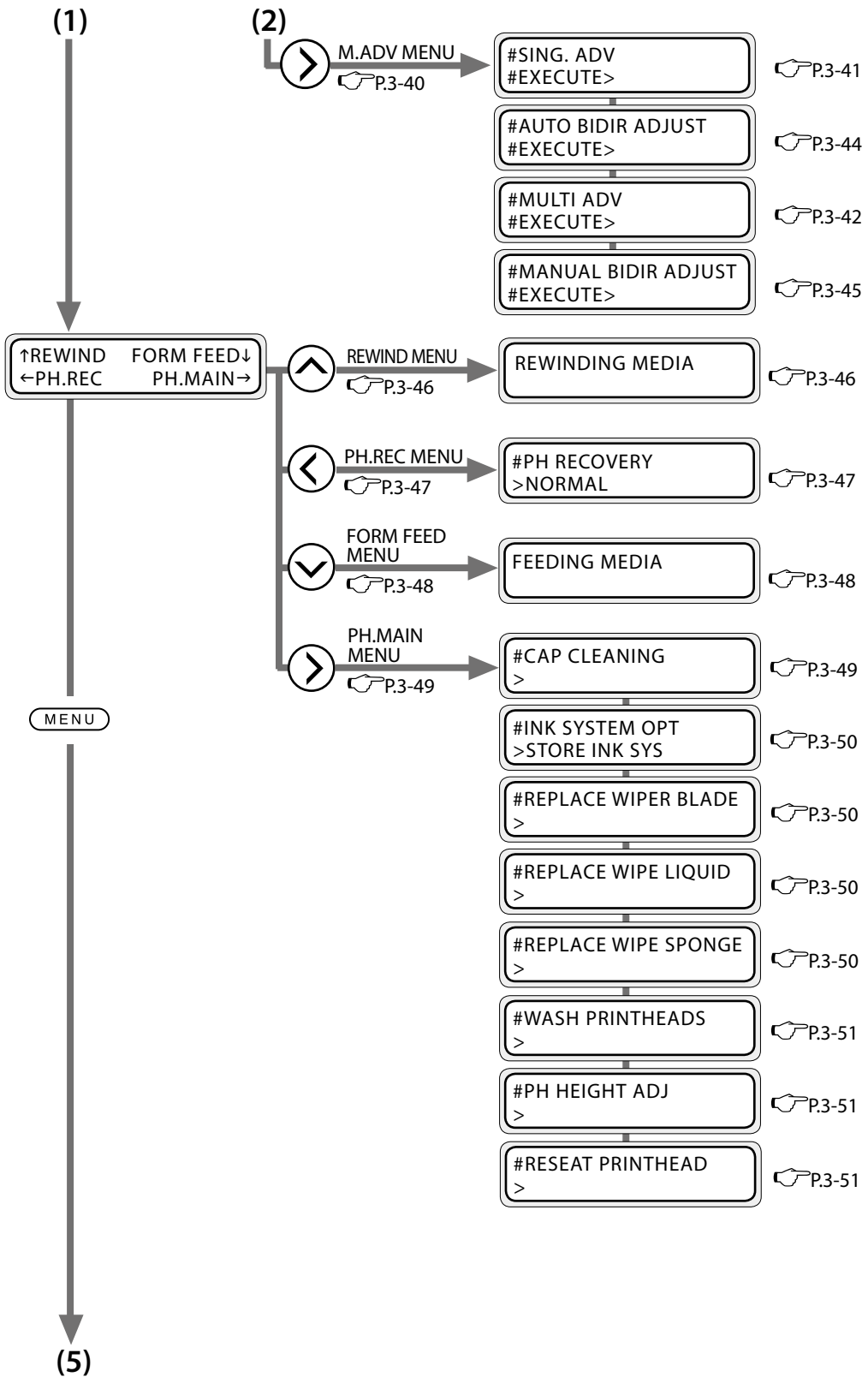

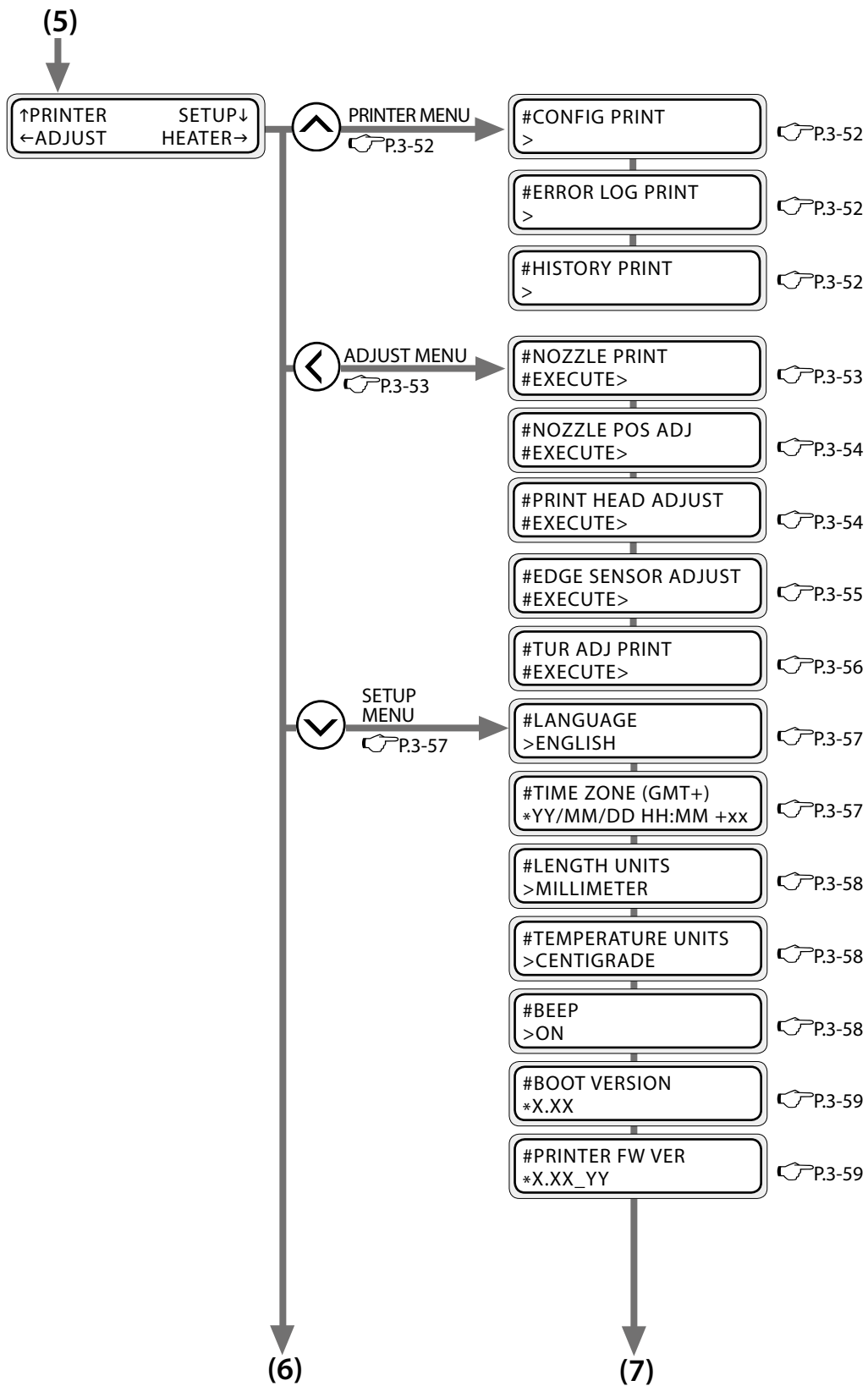

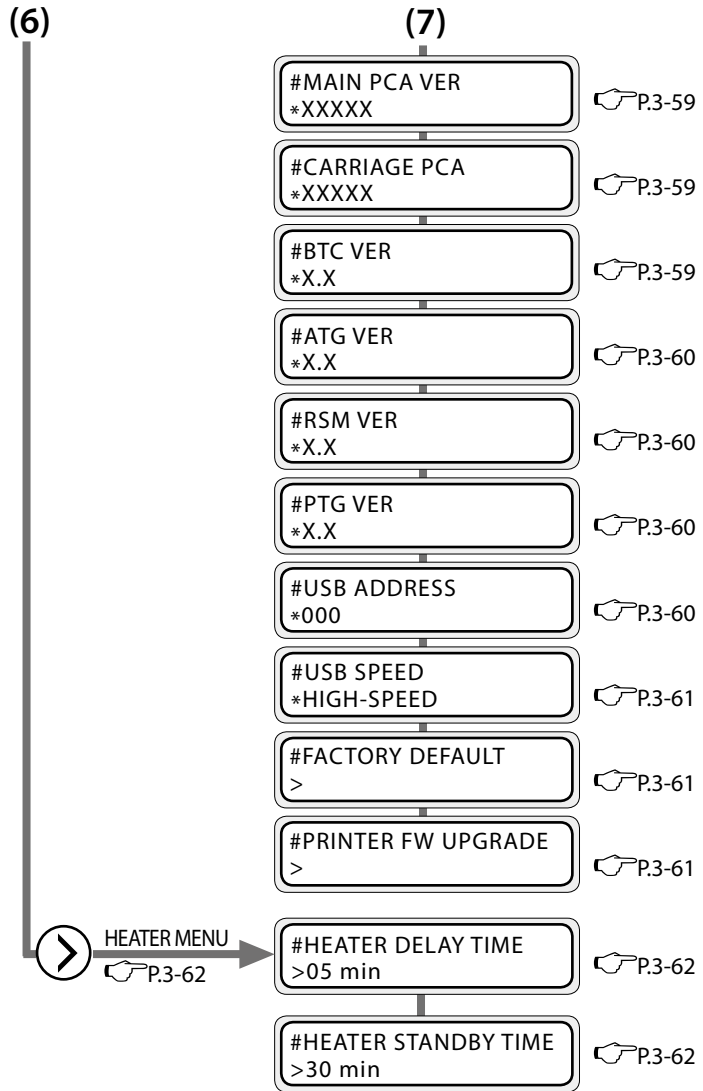

**Note**

- The parameter units displayed in each menu are as specified in the **SETUP MENU**.  
**Length : [LENGTH UNITS] (meter system, inch system) in the SETUP MENU**  
**Temperature : [TEMPERATURE UNITS] (centigrade, fahrenheit) in the SETUP MENU**

---

## Basic operation procedure and keys used

### (1) Set the printer in the menu operable state.

- The menu becomes accessible in the offline state.
- The menu group screen is displayed in the offline state.

### (2) Select the menu group.

, , ,  keys

: These select the desired menu group.

 key

: This steps to the next menu group on the screen.



### (3) Select the menu.

,  keys : These step through menus on the same layer.

 key : The printer returns to the higher menu group.

 key : The menu is selected and parameters can be changed.

### (4) Set or change the parameters.

,  keys : Parameters are changed with these keys. numerical values are increased or decreased with these keys.

,  keys : Digits are selected with these keys when entering numerical values.

### (5) Confirming or canceling the set parameter

 key : This key completes the parameter change.

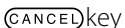
 key : This key cancels the entered parameter and the printer returns to the menu selection state.

### (6) Setting finish

Press  key to return to the online state.

## Procedure selection, numerical input, execution and character input

### ■ When the parameter is the selection input method

The procedure for [PRINT MODE] in the MEDIA REG MENU is explained.

- 1** With  $\uparrow$ ,  $\downarrow$ ,  $\leftarrow$ ,  $\rightarrow$  keys, select the menu group. Select MEDIA REG MENU with  $\downarrow$  key.

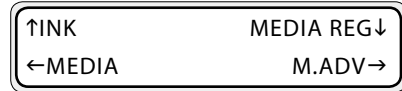

- 2** With  $\uparrow$ ,  $\downarrow$  keys, select the lower layer menu of MEDIA REG MENU.

Here, select [PRINT MODE]. Press the  $\leftarrow$  key, to return to the state in step **1**.



- 3** To change the parameter, press  $\text{OK}$  key.



- 4** With  $\uparrow$ ,  $\downarrow$  keys, select the parameter for the menu.

Here, select [HIGH QUALITY].

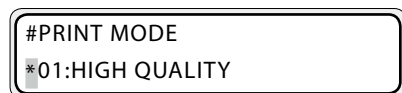

- 5**  $\text{OK}$  Press key. The parameter change is saved and the printer returns to the state in step **2**.

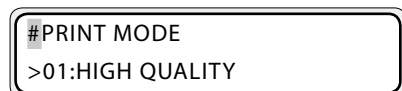

---

## ■ When the parameter is the numeral input method

The procedure for [MEDIA ADV VALUE] in the MEDIA REG MENU is explained.

- 1** With , , ,  keys, select menu group.



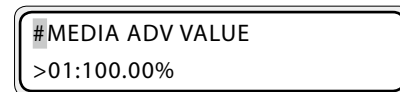

With  key, select MEDIA REG MENU.

- 2** With ,  keys, select the lower layer menu of MEDIA REG MENU.





Here, select [MEDIA ADV VALUE].

Press the  key, to return to the state in step **1**.

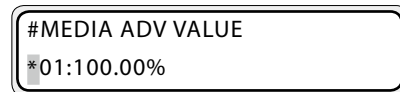
- 3** To change the parameter, press  key.



- 4** With ,  keys, move to the digit to be changed.

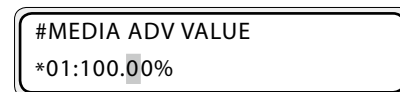

- 5** Press ,  keys to correct the numeral.

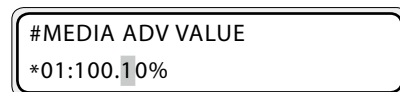

- 6** Press the  key. The parameter change is executed and the printer returns to the state in step **2**.

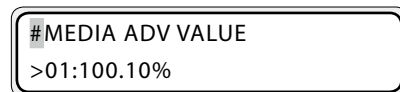



## ■ When the parameter is an execution command

### Case 1 : In case of executing a print

The procedure for [CONFIG PRINT] in the PRINTER MENU is explained.

- 1** With , , ,  keys, select the menu group.

With , select PRINTER MENU.



- 2** With ,  keys, select the lower layer menu of printer menu.

Select [CONFIG PRINT]. Press the , key, to return to the state in step 1.



- 3** Press  key.



- 4** To execute, press  key.

To return to the state in step 2 without executing, press  key.



- 5** After finishing the execution, the printer returns to the state in step 2.

---

## Case 2 : When the parameter is displayed only

The procedure for [BOOT VERSION] menu in SETUP MENU is explained.

- 1** With , , ,  keys, select the menu group.

With  key, select the setup menu.

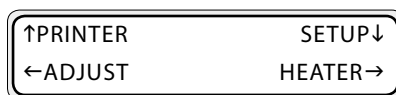

- 2** With ,  keys, select the lower layer menu of setup menu.

When [BOOT VERSION] is selected, the content is displayed.

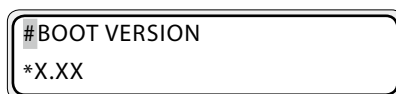

\*X : BOOT version

- 3** With ,  keys, other lower layer menu in SETUP MENU can be selected.

Press the  key, to return to the state in step **1**.

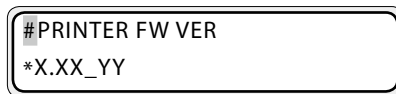

### ■ When the parameter is the character input method

The procedure for [RENAME MEDIA] in the MEDIA REG MENU is explained.

- 1** With , , ,  keys, select the menu group.

With  key, select MEDIA REG MENU.

↑INK	MEDIA REG↓
←MEDIA	M.ADV→







- 2** With ,  keys, select the lower layer menu of MEDIA REG MENU.

Select [RENAME MEDIA].

#RENAME MEDIA
>02:TYPE02



- 3** To change the parameter, press  key.

#SELECT MEDIA
>02:TYPE02

- 4** With  +  keys or  +  keys, change the character code group.
- With  key or  key, change the character.

( Refer to **P3-16 <Character Selection Table>**)

#SELECT MEDIA
>02:ATYPE02





- 5** With ,  keys, move to the digit to be changed and change the character.

#SELECT MEDIA
>02:ABCD02

- 6** To confirm the setting, press  key.

#RENAME MEDIA
>02:ABCDEF

<Character Selection Table>

Character code group		Character  key ← →  key
<p>Backward            ( MENU +  key)</p> <p style="text-align: center;">↕</p> <p>Forward            ( MENU +  key)</p>	Symbols	space, !, . . . .
	Numerals	0 to 9
	Alphabet • Capital letter	A to Z
	Alphabet • Small letter	a to z
	Special characters	a, ä, b, . . . .

# Explanation of each menu operation

- Information regarding Lm (light magenta) and LC (light cyan), or Ny (neon yellow) and Np (neon pink) in each menu is displayed only for 6 color specifications printers. Information regarding these colors is not displayed for 4 color specifications printers.



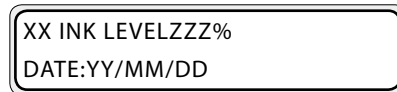
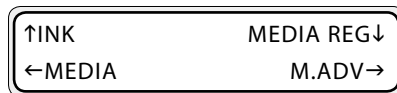

## INK MENU

Displays the ink information. When pressing  key, the ink information of each color is displayed in 3 second intervals.



XX : Ink color (Y/M/C/K/Lm/Lc/Np/Ny)  
ZZZ : Remaining amount of ink  
YY : Year, MM : Month DD : Day

The display order of ink colors is Y → M → C → K → Lm → Lc.  
When using neon ink, the order is Y → M → C → K → Np → Ny.

- (1) INK LEVEL shows the remaining ink.  
DATE shows the production date of ink cartridges.
- (2) By pressing  key, the display proceeds to the next color without resting for 3 seconds.
- (3) When pressing  key or  key, the printer returns to the offline state (menu mode) display.
- (4) To move to the online state (idle mode) display, press  key.

### Note

- [YY INK LEVELLOW] is displayed when the remaining ink becomes low.

## MEDIA MENU

Shows the media information. When pressing  key, the following media information is displayed.

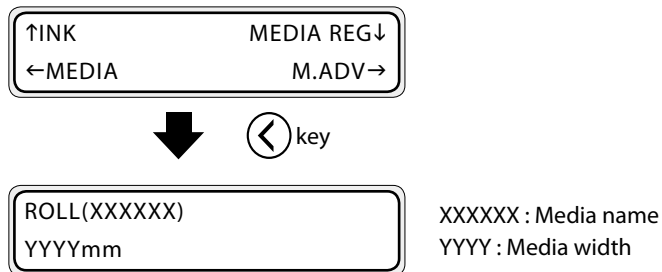

### (1) Media

Displays information about the media currently set.

When roll media or nest is set, the media name and width are displayed.

When sheet media is set, the media name, width and length are displayed.

<For roll media>

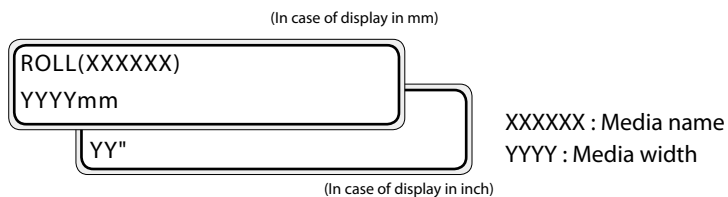

<For cut media (sheet)>

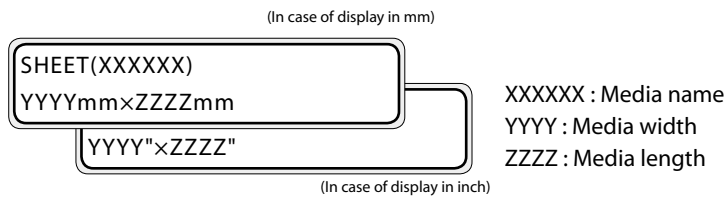

<In case of nest (the print origin is set with the origin setting function)>

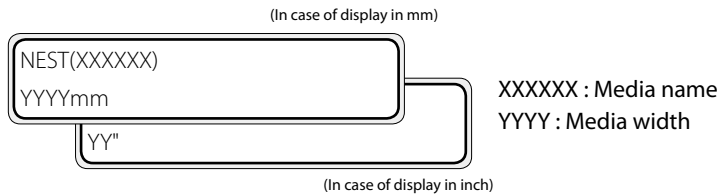

## (2) Remaining media

Set the amount of remaining media.

Remaining media is displayed according to the set length unit.



<Parameter (numeral input)>

000 to 999	When length is displayed in millimeter
0000 to 3278	When length is displayed in inch

When \*\*\* or \*\*\*\* is displayed, the remaining media information is not available.

### Note

- The REMAINING MEDIA setting menu is available only when the media is set to [ROLL] or [NEST].

## (3) Media type

Set the registration number (media type) for the current media.

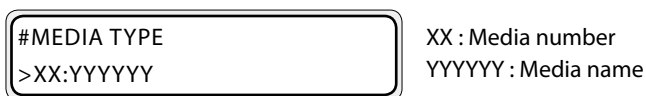

### Note

- Only already registered media can be selected here.  
Also, if the media registration number is changed, the related heater temperature setting returns to the media default value.



- Pressing the **CANCEL** or **←** key in the MEDIA menu returns the printer to the offline state display (menu mode).
- Pressing the **ONLINE** key in the MEDIA menu puts the printer to the online state display (idle mode).

## MEDIA REG MENU

Set the parameters used for printing. To set the parameter, press  key.



XX : Media number  
YY : Media name



**HINT**

20 pieces of media information of the following MEDIA REG MENU can be registered.

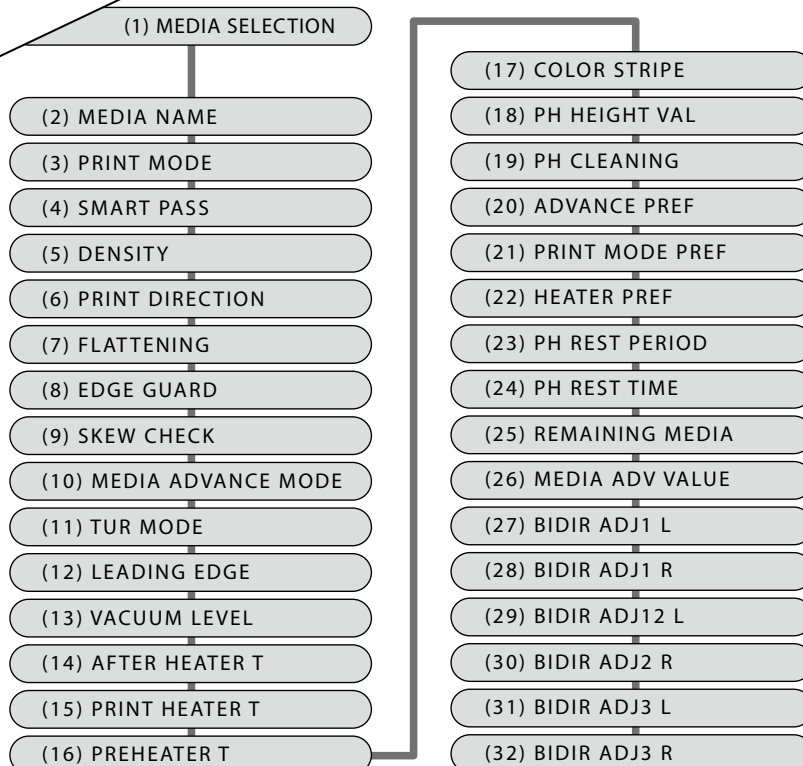
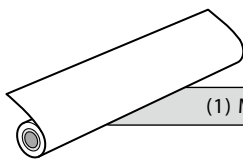

The function to delete a registered media is also available.

 P.3-37 [(33) DELETE MEDIA]

The function to copy the parameters of one media to other media is available.



 P.3-38 [(34) COPY MEDIA], P.3-38 [(35) PASTE MEDIA]



■ How to select the media

- 1** Select the MEDIA REG MENU with  key.





- 2** Select [SELECT MEDIA] with ,  keys.

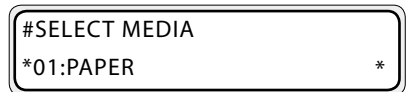

When the media is already registered, [\*] mark is displayed.

- 3** To change the parameter, press  key.



- 4** Select the media number you want to register with ,  keys.



- 5** Press  key. The media number is set and the printer returns to the state in step 2.

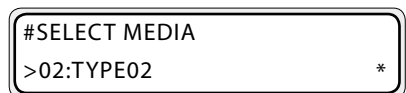

## ■ Preset media initial value

A maximum 20 types (media No. 01 to 20) of media can be saved. A saved media can be modified and deleted. However, the media No. 01 (PAPER) and the media currently set into the printer cannot be deleted. The initial values are shown below.

Media number Setting	01	02	03	04	05
Media	PAPER	Glossy	Matte	Banner	BLT_B
Print mode	NORMAL	NORMAL	NORMAL	NORMAL	NORMAL
SMART PASS	LOW	LOW	LOW	LOW	LOW
DENSITY	NORMAL	NORMAL	NORMAL	NORMAL	HIGH DENSITY
PRINT DIRECTION	BIDIR	BIDIR	BIDIR	BIDIR	BIDIR
FLATTEN TIME	NONE	NONE	NONE	NONE	NONE
EDGE GUARD	YES	YES	YES	YES	YES
SKEW CHECK	ON	ON	ON	ON	ON
MEDIA ADV MODE	FWD ONLY	FWD ONLY	FWD ONLY	FWD ONLY	FWD ONLY
TUR MODE	LOOSE	LOOSE	LOOSE	LOOSE	LOOSE
LEADING EDGE	NORMAL	NORMAL	NORMAL	NORMAL	NORMAL
SUCTION FAN LEVEL	NORMAL	NORMAL	NORMAL	NORMAL	NORMAL
AFTER HEATER T	** (OFF)	45°C	45°C	45°C	45°C
PRINT HEATER T	** (OFF)	40°C	40°C	40°C	40°C
PREHEATER T	** (OFF)	45°C	45°C	45°C	45°C
COLOR STRIPE	ON	ON	ON	ON	ON
PH HEIGHT VAL	NORMAL	NORMAL	NORMAL	NORMAL	NORMAL
PH CLEANING	REDUCED	REDUCED	REDUCED	REDUCED	REDUCED
ADVANCE PREF	SOFTWARE	SOFTWARE	SOFTWARE	SOFTWARE	SOFTWARE
PRINT MODE PREF	SOFTWARE	SOFTWARE	SOFTWARE	SOFTWARE	SOFTWARE
HEATER PREF	SOFTWARE	SOFTWARE	SOFTWARE	SOFTWARE	SOFTWARE
PH REST PERIOD	0000CYCLES	0000CYCLES	0000CYCLES	0000CYCLES	0000CYCLES
PH REST TIME	10sec	10sec	10sec	10sec	10sec
REMAINING MEDIA	0m	0m	0m	0m	0m
MEDIA ADV VALUE	100.00 %	100.00 %	100.00 %	100.00 %	100.00 %
ADJ1 (L)	00	00	00	00	00
ADJ1 (R)	00	00	00	00	00
ADJ2 (L)	00	00	00	00	00
ADJ2 (R)	00	00	00	00	00
ADJ3 (L)	00	00	00	00	00
ADJ3 (R)	00	00	00	00	00

■ How to set a parameter

Here, the entry of the MEDIA ADVANCE VALUE (☞ P.3-35) in the media number [02] is explained.

- 1** In the MEDIA REG MENU, display [#MEDIA ADV VALUE] with ▲, ▼ keys.

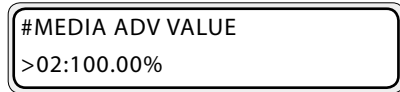

- 2** Press OK key to change the parameter, then correct the parameter.

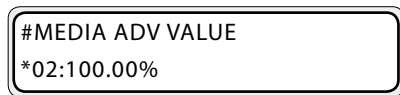

**Note**

- Print an adjustment pattern to set the media advance value. (☞ P.4-32)

- 3** Press OK key. The following message is displayed.  
(This message is displayed only for new registrations.)

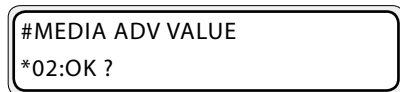

- 4** Register to the media number 02 with OK key. A "\*" (asterisk indicates a registered media) is appended to the end of media on the LCD screen and the printer returns to the state in step 1.

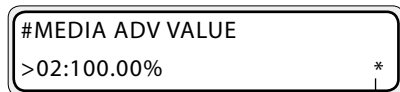

When the media is already registered, [\*] mark is displayed.

To cancel, press CANCEL key. The new registration stops and the printer returns to the state in step 1.

---

## (1) SELECT MEDIA

Select the new registration or the media number of a media of which parameters have been changed. 20 types of media numbers from [01] to [20] can be selected.

#SELECT MEDIA  
>XX:YYYYYY

XX : Selected media number  
YYYYYY : Media name



**HINT**

- When entered in the MEDIA REG MENU, the currently set media number is displayed first. When no media is loaded, the media number [01] is displayed.

<Parameter (selection)>

01 to 20

## (2) RENAME MEDIA

Name (register) the media number selected in the [SELECT MEDIA]. Six (6) digits of character (or symbol) can be entered for the media name. For character string, symbols and alpha-numerals can be used.

#RENAME MEDIA  
>XX:YYYYYY

XX : Selected media number  
YYYYYY : Media name

<Parameter (character input)>

6 digit character input (symbol, alpha-numeral and other)  **P.3-16**

## (3) PRINT MODE

Select the print resolution. A high resolution means a good print quality for an output which looks less granular.

#PRINT MODE  
>XX:NORMAL

XX : Selected media

<Parameter (selection)>

NORMAL

HIGH QUALITY

MAX QUALITY

HIGH SPEED

For characteristics of print mode, refer to the list below.

There are 4 types of print mode. Choose the suitable mode to meet the type of media, productivity and image quality.

### 1. NORMAL [productivity + image quality weight]

The printer prints with a resolution of 540 × 540 dpi. Normally, use this mode. This mode is balanced between productivity and image quality.

### 2. HIGH QUALITY [image quality weight]

The printer prints with a resolution of 720 × 720 dpi. Use this mode to prioritize image quality. The definition of the output is better than with normal mode.

### 3. MAX QUALITY [image quality weight]

The printer prints with a resolution of 900 × 900 dpi. Use this mode to prioritize image quality. Choose this mode to obtain the best resolution with this printer.

### 4. HIGH SPEED [productivity weight]

The printer prints with a resolution of 540 × 360 dpi. Use this mode to prioritize productivity. The print speed is 1.5 times faster than with normal mode.

#### Note

- **The recommended print mode is [NORMAL]. Use other modes for increased productivity or picture quality depending on customer requirements.**
- **The better the resolution, the slower the print speed.**

## (4) SMART PASS

Select the intensity for the auto correction function which ameliorates the print quality. Three parameters, low, medium and high are available for the correction intensity (amelioration effect).

```
#SMART PASS
>XX:LOW
```

XX : Selected media number

#### <Parameter (selection)>

LOW	Normally, use this setting. This setting allows the best productivity.
MEDIUM	Choose this setting if you get trouble with banding or color irregularities. The image quality amelioration effect is increased.
HIGH	Choose this setting if the medium setting did not ameliorate the image quality. The amelioration effect will be further increased.

#### Note

- **With the MEDIUM setting the print speed is 33% slower than with LOW setting.**
- **With the HIGH setting the print speed is 50% slower than with LOW setting.**
- **The higher the correction intensity, the slower the print speed.**



- Considering the PRINT MODE and SMART PASS settings, the print speed is shown in the following table.

**Note**

- **The print speed below is with bidirectional printing. The print speed is halved with unidirectional printing.**

Model name	Print mode	Print resolution	Maximum printing speed (bidirectional) [m <sup>2</sup> /h] (*1)		
			Smart pass Low	Smart pass Medium	Smart pass High
IP-5620	High Speed	540×360 dpi	17.8 (*2)	11.7	8.8
	Normal	540×540 dpi	11.9	8.0	5.9
	High Quality	720×720 dpi	7.2	4.7	3.6
	Max Quality	900×900dpi	4.7	3.1	2.4
IP-5520	High Speed	540×360 dpi	16.8 (*2)	11.0	8.3
	Normal	540×540 dpi	11.2	7.5	5.6
	High Quality	720×720 dpi	6.8	4.5	3.4
	Max Quality	900×900dpi	4.4	3.0	2.2

\*1 This table shows the maximum speed for each mode. The actual print speed may be slower depending on the media width or other conditions.

\*2 When the settings are [PRINT MODE] : [HIGH SPEED] and [SMART PASS] : [LOW], the [SMART PASS] setting will automatically change to [HIGH] if the environment temperature is lower than 20°C.

**(5) Density**

Select the print density.

#DENSITY  
>XX:NORMAL

XX : Selected media number

<Parameter (selection)>

NORMAL	Normally, select this setting.
HIGH DENSITY	Choose this setting when you need to print with high density. The density is 1.5 to 2 times higher without loss to the print speed.



- The result of HIGH DENSITY will depend on the PRINT MODE setting.
- With a NORMAL density at 1.0, the density of HIGH DENSITY will be as follows.

Print mode	Density	
	Normal	High Density
High Speed	1.0	1.0(*1)
Normal	1.0	1.5(*2)
High Quality	1.0	2.0
Max Quality	1.0	2.0

\*1 With [PRINT MODE] set to [HIGH SPEED], the density will not change even by setting [DENSITY] to [HIGH DENSITY].

\*2 The [SMART PASS] setting automatically changes to [MEDIUM] when:

- [PRINT MODE] is set to [NORMAL];
- [DENSITY] is set to [HIGH DENSITY];
- [SMART PASS] is set to [LOW]; and
- The environment temperature is lower than 20°C.

**Note**

- **A large amount of ink is used with [HIGH DENSITY], so color blurs or ink drying problems may occur. In these cases, slow down the print speed.**

**(6) PRINT DIRECTION**

Select the print direction of a media.

#PRINT DIRECTION  
>XX: BIDIR

XX : Selected media number

<Parameter (selection)>

BIDIR	Printing is performed in two directions.
UNIDIR	Printing is performed in only one direction.

● Bidirection print

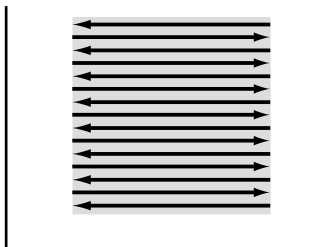

↔ : Print head movement

■ : Print image

● Unidirection print

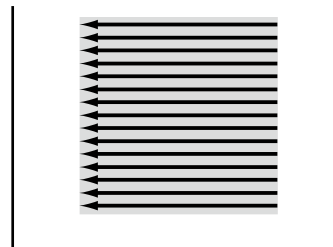

← : Print head movement

■ : Print image

---

## (7) FLATTENING MODE

Select the FLATTENING MODE. If the media stay for a long period of time set in the printer, the leading edge of roll media can wrinkle or get dirty, resulting in print defects. This can be due to humidity or dust. To avoid this, use this function.

#FLATTEN TIME

>XX:NONE

XX : Selected media number

Set the parameters for flatten time setting based on the operating conditions. When the printer is set without receiving data, after the set time passes, the leading edge of roll media is automatically advanced in the front of the front cover. (When the leading edge of roll media is already present in front of the front panel, this action is omitted.) After printing starts, the media flattening (repeated actions of advancing and rewinding the media) is automatically performed. Moreover, when the power is turned off, the leading edge of roll media is automatically advanced in front of the front cover and the power is shut down. (When using the media take-up reel unit, the power is shut down without flattening.)

### <Parameter (selection)>

NONE	This operation is not performed. When printing continuously or when using a wrinkle-free media, select this setting. But, when the printer rests a long time in standby, the media could be wrinkled leading to print defects.
30 min	After 30 minutes pass, this operation is performed. Even before 30 minutes, every time a print starts, the media flattening is performed. When printing in high humidity environment and the media wrinkles frequently, set the parameter to this setting.
1 hour	After 1 hour passes, this operation is performed. When the interval between prints is often 1 hour and the media wrinkles frequently, set the parameter to this setting.
2 hours	After 2 hours pass, this operation is performed. When the interval between prints is often 2 hours and the media wrinkles frequently, set the parameter to this setting.
4 hours	After 4 hours pass, this operation is performed. When the interval between prints is often 4 hours and the media wrinkles frequently, set the parameter to this setting.



**(8) EDGE GUARD**

Select whether the media edge guards are used or not. With this setting, the right and left margins of the media change.

```
#USE EDGE GUARD
>XX:YES
```

XX : Selected media number

<Parameter (selection)>	
YES	Set when the edge guards are used.
NO	Set when the edge guards are not used.



- When the edge guards are used, the right and left margins of print are 10 mm. When not used, the right and left margins are 5 mm.

**(9) SKEW CHECK**

Select whether a skew check is performed during printing.

```
#SKEW CHECK
>XX:ON
```

XX : Selected media number

<Parameter (selection)>	
ON	A skew check is performed at regular intervals during printing.
OFF	Skew checks are not performed during printing.

**(10) MEDIA ADV MODE**

Select a media advance mode.

```
#MEDIA ADV MODE
>XX:FWD ONLY
```

XX : Selected media number

<Parameter (selection)>	
FWD ONLY	Media is fed in the normal media advance sequence.
BACK & FWD	Media is fed in a media adhesion prevention sequence. The media is slightly wiggled forward and backward while being fed. (The print speed is slower than with FWD ONLY).

**(11) Take-up (TUR) MODE**

Select the take-up (TUR) mode when winding the media with the take-up reel.

```
#TUR MODE
>XX:LOOSE
```

XX : Selected media number

<Parameter (selection)>	
LOOSE	The take-up reel is in the loose (slack) mode.
TENSION	The take-up reel is in the tension mode.

**Note**

- Select [LOOSE] when the take-up reel (TUR) is not used.

---

## (12) LEADING EDGE

Detects the edge of the media when replacing or setting the media, and selects whether the media should be returned to the waiting position. When the take-up reel unit is used, the media will not be returned to the waiting position regardless of this setting.

#LEADING EDGE  
>XX:NORMAL

XX : Selected media number

<Parameter (selection)>

NORMAL	Detects the media width when replacing or setting the media, and then completes the media setting after checking media skew during media feeding.
DEDUCED	Detects the media width when replacing or setting the media and then completes the media setting after detecting the edge of the media during media rewinding.

---

### Note

- Usually set [NORMAL]. When selecting [REDUCED,] take care of the followings.
- Cut the edge of the media so that the edge of the media is parallel to the platen and set it to the printer. If the edge of the media is not parallel, it may cause print defects on the leading edge of the media, the platen to be stained by ink and media jams.
- Set the media after checking that there is no tape or glue on the edge of the media. Using such media may cause media jams.

## (13) SUCTION FAN LEVEL

Select the force (speed of fan) to draw the media to the platen.

#SUCTION FAN LEVEL  
>XX:NORMAL

XX : Selected media number

<Parameter (selection)>

NORMAL	Draws the media by normal amount of force.
LOW	Draws the media with less than normal amount of force.

---

### Note

- With very soft media like clothes, select [LOW] when wrinkles appear.
- When [LOW] is selected, the airflow of the blower unit (option) also becomes low.

**(14) AFTER HEATER T**

Set the after heater temperature. However, when "\*\*\*" is set, the after heater does not work.

(When temperature unit is Centigrade)

```
#AFTER HEATER T
>XX:30°C
```

(When temperature unit is Centigrade)

```
#AFTER HEATER T
>01:086°F
```

<Parameter (numeral input)>

15°C to 55°C	Centigrade temperature setting range
59°F to 131°F	Fahrenheit temperature setting range

**(15) PRINT HEATER T**

Set the print heater temperature. However, when "\*\*\*" is set, the print heater does not work.

(When temperature unit is Centigrade)

```
#PRINT HEATER T
>01:30°C
```

(When temperature unit is Centigrade)

```
#PRINT HEATER T
>01:086°F
```

<Parameter (numeral input)>

15°C to 55°C	Centigrade temperature setting range
59°F to 131°F	Fahrenheit temperature setting range

**(16) PREHEATER T**

Set the preheater temperature. However, when "\*\*\*" is set, the preheater does not work.

(When temperature unit is Centigrade)

```
#PRE HEATER T
>01:50°C
```

(When temperature unit is Centigrade)

```
#PRE HEATER T
>01:122°F
```

<Parameter (numeral input)>

15°C to 55°C	Centigrade temperature setting range
59°F to 131°F	Fahrenheit temperature setting range



- Switching the display between Centigrade temperature and Fahrenheit temperature is performed with (4) Temperature Units in SETUP MENU. (🔍 P.3-58)

Centigrade/Fahrenheit conversion formula  
 $F=(9/5)C+32$   
 $C=(5/9)(F-32)$

---

## (17) COLOR STRIPE

Select whether the color stripe is printed or not.

#COLOR STRIPE  
>XX:ON

XX: Selected media number

<Parameter (selection)>

ON	The color stripe is added.
OFF	The color stripe is not added.



- Loss of print data (clogged nozzles) may be experienced when the color stripe is not added. We recommend the use of the color stripe as much as possible.
- Regardless of this setting, the color stripe is added in the various adjustment patterns in the offline mode.
- With the color stripe to ON, the print region becomes narrower by about 20 mm.

## (18) PH HEIGHT VAL

Select the head height with regard to the initial height and the thickness of the media.

#PH HEIGHT VAL  
>XX:NORMAL

XX: Selected media number

<Parameter (selection)>

NORMAL	Use this setting in normal operation.
HIGH	Use this setting when the print head is set to the HIGH position.

---

### Note

- **Select when changing the head height at the printer side. (🔑P.2-28)**

**(19) PH CLEANING**

Select whether to automatically perform cleaning to maintain the print heads in good operating condition.



XX : Selected media number

<Parameter (selection)>

REDUCED	Cleaning is executed automatically at the start or end of a print depending on print history. * When REDUCED is selected, less ink is used during automatic cleaning.
OFF	Automatic cleaning is not executed. * When OFF is selected, execute a nozzle print to check the printer condition, and if necessary perform a print head cleaning before printing.
NORMAL	Cleaning is executed automatically at the start or end of a print depending on print history. * When NORMAL is selected, automatic cleaning is performed to ensure a more constant print quality.

**(20) ADVANCE PEF**

Select the priority of MEDIA ADVANCE VALUE.

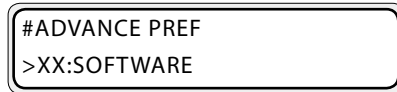

XX : Selected media number

<Parameter (selection)>

SOFTWARE	Data (advance value) sent from RIPof the computer has the priority.
FRONT PANEL	The advance value set in the MEDIA REG MENU (or M.ADV MENU) of the printer has the priority.

**(21) PRINT MODE PEF**

Select the print mode (print mode, smart pass, density) priority.

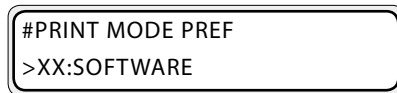

XX : Selected media number

<Parameter (selection)>

SOFTWARE	Data (print mode, smart pass, density) sent from RIPof the computer has the priority.
FRONT PANEL	The print mode, smart pass and density set in the MEDIA REG MENU of the printer have the priority.

---

## (22) HEATER PREF

Select the heater temperature setting priority.

#HEATER PREF  
>XX:SOFTWARE

XX: Selected media number

<Parameter (selection)>

SOFTWARE	Data (temperature) sent from RIPof the computer has the priority.
FRONT PANEL	The temperature set in the MEDIA REG MENU of the printer has the priority.

## (23) PH REST PERIOD

During printing, scanning of printer heads stops at a certain print length interval.

Use this setting to prevent print misses. Normally, set it to [0000CYCLES].

#PH REST PERIOD  
>XX:0000CYCLES

XX: Selected media number



- Set the number of scan for print length in [(23) PH REST PERIOD].
- Set the rest time in [(24) PH REST TIME].

<Parameter (numeral input)>

0000 to 9999	With [0] the scan rest is not performed.
--------------	--

## (24) PH REST TIME

Set the rest time in relation to [(23) PH REST PERIOD]. When [0] is set in [(23) PH REST PERIOD], this parameter is ignored.

Use this setting to prevent print misses. Set it to [10 sec] as a general rule.

#PH REST TIME  
>XX:10sec

XX: Selected media number

<Parameter (numeral input)>

1 to 99 seconds
-----------------

**(25) REMAINING MEDIA**

Set the remaining media length. By setting the remaining media in advance, the amount of the remaining media after printing becomes available in the MEDIA MENU.

Enter "\*\*\*" to disable the remaining media control.

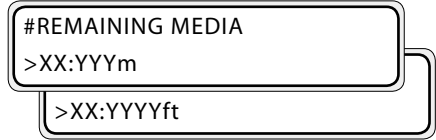

XX : Selected media number  
YY : Remaining media

<Parameter (numeral input)>

0 to 999 m	The input unit in the meter unit system is meter (m).
0 to 3278 ft	The input unit in the inch unit system is feet (ft).



**HINT**

- The parameter display unit is set in [LENGTH UNITS] of the SETUP MENU.

**(26) MEDIA ADV VALUE**

Set the MEDIA ADVANCE VALUE.  
Set the advance value so that banding is not visible.

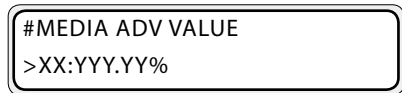

XX : Selected media number  
YYY.YY : MEDIA ADVANCE VALUE

<Parameter (numeral input)>

097.00 to 103.00 %
--------------------

**Note**

- For MEDIA ADVANCE VALUE setting, refer to [Section 4 Media advance value setting] (👉 P.4-32)

**(27) BIDIR ADJ1 L**

Correct the gap between forward and backward scanning during bidirectional printing. ADJ1 sets the adjustment value for HIGH SPEED and NORMAL print modes. This parameter sets the value for the left side.



YY : Ink color  
XX : Selected media number

Display order Y → M → C → K → Lm → Lc

<Parameter (numeral input)>

±, -15 to +15
---------------

**Note**

- For the method to determine the adjustment value, refer to [Section 4 Head position adjustment] (👉 P.4-41).

---

**(28) BIDIR ADJ1 R**

Sets the adjustment value for the right side for HIGH SPEED and NORMAL print modes.

#BIDIR ADJ1 R	YY
>XX:+00	

Display order Y → M → C → K → Lm → Lc

YY: Ink color  
XX: Selected media number

<Parameter (numeral input)>

±, -15 to +15

---

**Note**

- For the method to determine the adjustment value, refer to [Section 4 Head position adjustment] (☞ P.4-41).

**(29) BIDIR ADJ2 L**

ADJ2 sets the adjustment value for HIGH QUALITY print mode. This parameter sets the value for the left side.

#BIDIR ADJ2 L	YY
>XX:+00	

Display order Y → M → C → K → Lm → Lc

YY: Ink color  
XX: Selected media number

<Parameter (numeral input)>

±, -15 to +15

---

**Note**

- For the method to determine the adjustment value, refer to [Section 4 Head position adjustment] (☞ P.4-41).

**(30) BIDIR ADJ2 R**

Sets the adjustment value for the right side for HIGH QUALITY print mode.

#BIDIR ADJ2 R	YY
>XX:+00	

Display order Y → M → C → K → Lm → Lc

YY: Ink color  
XX: Selected media number

<Parameter (numeral input)>

±, -15 to +15

---

**Note**

- For the method to determine the adjustment value, refer to [Section 4 Head position adjustment] (☞ P.4-41).



**(31) BIDIR ADJ3 L**

ADJ3 sets the adjustment value for MAX QUALITY print mode. This parameter sets the value for the left side.

```
#BIDIR ADJ3 L      YY
>XX:+00
```

YY: Ink color  
XX: Selected media number

Display order Y → M → C → K → Lm → Lc

<Parameter (numeral input)>

±, -15 to +15

**Note**

- For the method to determine the adjustment value, refer to [Section 4 Head position adjustment] (P.4-41).

**(32) BIDIR ADJ3 R**

Sets the adjustment value for the right side for MAX QUALITY print mode.

```
#BIDIR ADJ3 R      YY
>XX:+00
```

YY: Ink color  
XX: Selected media number

Display order Y → M → C → K → Lm → Lc

<Parameter (numeral input)>

±, -15 to +15

**Note**

- For the method to determine the adjustment value, refer to [Section 4 Head position adjustment] (P.4-41).

**(33) DELETE MEDIA**

Delete a registered media.  
Registered media no. 01 to 20 can be selected.  
The registered media 01 is set as a reference and cannot be deleted. Also, the media currently set in the printer cannot be deleted.  
To delete a media, press **OK** key when the confirmation screen appears.

```
#DELETE MEDIA
>02:TYPE02
```



```
#DELETE MEDIA
*02:TYPE02 OK ?
```

---

### (34) COPY MEDIA

Select the media number to copy.

It is used to copy the media information (parameters) of one registered media to another media. Set the copy destination in [(35) PASTE MEDIA].

#COPY MEDIA >XX
--------------------

XX : Copy source media number

---

#### Note

- **When the media number designated as the copy source is deleted, the copy source is automatically set to [01].**

<Parameter (selection)>

01 to 20	Only the registered numbers are displayed.
----------	--

### (35) PASTE MEDIA

Select the media number of the copy destination.

#PASTE MEDIA >XX→YY*
-------------------------

XX : Copy source media number

YY : Copy destination media number

<Parameter (selection)>

01 to 20	The numbers of media already registered are displayed as "*".
----------	---

### ■ COPY MEDIA, PASTE MEDIA

Select the copy source and the copy destination to copy the media parameters. The copied parameters are the contents of the settings **(2)** to **(35)** in the MEDIA REG MENU.

With the function to copy the information of registered media, the parameters can be copied using [(34) COPY MEDIA] and [(35) PASTE MEDIA] as a set. For details, refer to the parameters copy procedure on the next page.

## ■ How to copy the parameter

Here, the procedure to copy the parameters of the media No. 13 to the media No. 20 is explained.

### 1 Select the copy source.

Select the media number with  $\uparrow$ ,  $\downarrow$  keys. (Only the registered numbers are displayed.)  
Confirm the media number to copy with  $\text{OK}$  key.

Press  $\text{CANCEL}$  key in any menu to return to the first menu.

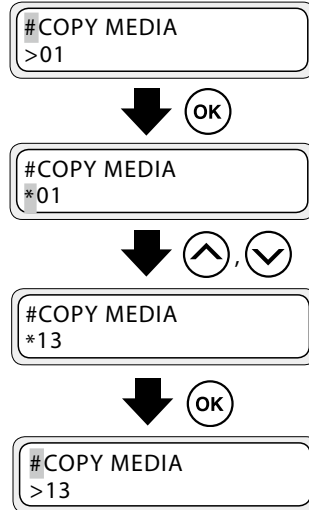

### 2 Select the copy destination.

On the display, the number (13) on the left hand side is the media number of the copy source and the number on the right hand side is the media number of the copy destination.

Select the media number with  $\uparrow$ ,  $\downarrow$  keys. (The copy destination numbers 01 to 20 are displayed.)

When the copy destination is already registered, \* is added to the end of the number.

Confirm the media destination number with  $\text{OK}$  key.

If the copy destination is a new registration, \* is not added to the end of the number.

With  $\text{OK}$  key, execute the parameter copy.

Press  $\text{CANCEL}$  key in any menu to return to the first menu.

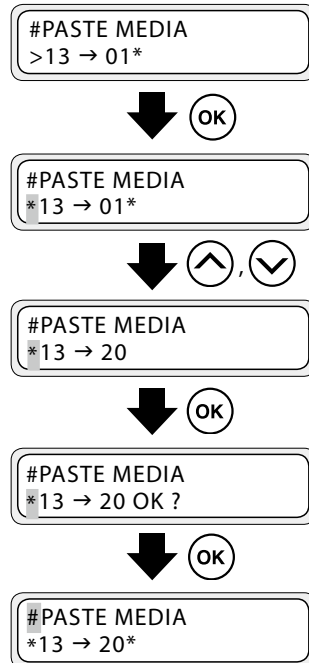

---

## M.ADV MENU

Set the parameters regarding media advance adjustment. Press  key to change the parameters.

---

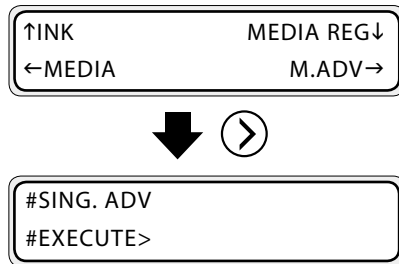



### ■ Advance adjustment

Perform the media advance adjustment when the media print conditions (media roll, heater temperature, vacuum level, pressure switch) have been changed. To determine the media advance adjustment value, print the adjustment pattern, read the adjustment value from the print pattern, then set the value to the printer. There are two types of adjustment patterns: SING. ADV and MULTI ADV. Both can be used.

- With SING. ADV, printing is performed with the current MEDIA ADV VALUE (one pattern).
- With MULTI ADV, printing is performed with the current MEDIA ADV VALUE - 0.2%, the current MEDIA ADV VALUE and the current MEDIA ADV VALUE + 0.2% (3 patterns).

Press  key to stop the printing of an adjustment pattern.

(1) **SING. ADV**

Press  and  keys to select the adjustment pattern to print (upper layer menu), and confirm with  key.  
Then, select and confirm the lower layer menu.

#SING. ADV  
#EXECUTE>



#MULTI ADV  
#EXECUTE>

**Lower layer menu: #EXECUTE: Print the media advance adjustment pattern with the current MEDIA ADV VALUE.**

<Parameter (execution)>  
NONE

**Lower layer menu: #PRINT MODE: Select the print mode to print the adjustment pattern.**

<Parameter (selection)>	
HIGH SPEED	Select to print in high speed mode.
NORMAL	Select to print in normal mode.
HIGH QUALITY	Select to print in high quality mode.
MAX QUALITY	Select to print in max quality mode.

**Lower layer menu: #Smart pass: Select the smart pass to print the adjustment pattern.**

<Parameter (selection)>	
LOW	Select to print with the low setting.
MEDIUM	Select to print with the medium setting.
HIGH	Select to print with the high setting.



**Lower layer menu: #ADJ VALUE: Enter the media advance adjustment value.**

<Parameter (numeral input)>	
97.00to103.00%	Adjustment value setting range.

**Note**

- When the settings are PRINT MODE: HIGH SPEED and SMART PASS: LOW, the SMART PASS setting will automatically change to MEDIUM if the environment temperature is lower than 20°C.

## (2) MULTI ADV

Press  and  keys to select the adjustment pattern to print (upper layer menu), and confirm with  key.

Then, select and confirm the lower layer menu.

#MULTI ADV  
#EXECUTE>



#SING. ADV  
#EXECUTE>

**Lower layer menu: #EXECUTE: Print 3 patterns with the current ADJ VALUE - 0.2%, the current ADJ VALUE and the current ADJ VALUE + 0.2%.**

<Parameter (execution)>

NONE

**Lower layer menu: #PRINT MODE: Select the print mode to print the adjustment pattern.**

<Parameter (selection)>

HIGH SPEED      Select to print in high speed mode.

NORMAL          Select to print in normal mode.

HIGH QUALITY    Select to print in high quality mode.

MAX QUALITY    Select to print in max quality mode.

**Lower layer menu: #Smart pass: Select the smart pass to print the adjustment pattern.**

<Parameter (selection)>

LOW              Select to print with the low setting.

MEDIUM        Select to print with the medium setting.

HIGH             Select to print with the high setting.

**Lower layer menu: #ADJ VALUE: Enter the media advance adjustment value.**

<Parameter (numeral input)>

97.00to103.00%    Adjustment value setting range.

### Note

- When the settings are PRINT MODE: HIGH SPEED and SMART PASS: LOW, the SMART PASS setting will automatically change to MEDIUM if the environment temperature is lower than 20°C.



- The adjustment value can be changed just before printing the adjustment pattern.

```
#SING. ADV: 100.00%
#EXECUTE>
```

Press the **OK** key to change the adjustment value.

```
#SING. ADV: 100.00%
#ADJ VALUE      *100.20%
```

Use the **▲** and **▼** keys to modify the adjustment value.

```
#SING. ADV: 100.20%
#ADJ VALUE      *OK ?
```

Then press **OK** key to confirm the value.

Press **OK** key again to start printing.

```
#SING. ADV: 100.20%
*EXECUTING
```

### ■ Bidirectional adjustment

Perform a bidirectional adjustment the media type (thickness) or the print head height has been changed.

To determine the bidirectional adjustment value, print the bidirectional adjustment pattern, read the adjustment value from the print pattern, then set the value to the printer.

ADJ1, ADJ2 and ADJ3 must be set for a bidirectional adjustment.

There are two types of bidirectional adjustment patterns: AUTO BIDIR ADJUST and MANUAL BIDIR ADJUST.



- With AUTO BIDIR ADJUST, one adjustment pattern (ADJ1) is printed Normally use this adjustment pattern.
- With MANUAL BIDIR ADJUST, several adjustment patterns (ADJ1, ADJ2, ADJ3) are printed to enable a more detailed adjustment.

AUTO BIDIR ADJUST is used to facilitate the adjustment operation. By performing one adjustment (ADJ1), the other adjustment values (ADJ2, ADJ3) are automatically set to the printer. To perform a more detailed adjustment, execute MANUAL BIDIR ADJUST and adjust the values individually.

Press **CANCEL** key to stop the printing of an adjustment pattern.

---

### (3) AUTO BIDIR ADJUST

Press  and  keys to select the bidirectional adjustment pattern to print (upper layer menu), and confirm with  key. Then, select and confirm the lower layer menu.

#AUTO BIDIR ADJUST  
#EXECUTE>



#MANUAL BIDIR ADJUST  
#EXECUTE>

**Lower layer menu: #EXECUTE: Print the selected bidirectional adjustment pattern.**

<Parameter (execution)>  
NONE

**Lower layer menu: #ADJ L Enter the bidirectional adjustment value for the left side.**

<Parameter (numeral input)>  
Range:-15to+15



**HINT**

- After entering this adjustment value, parameters for each print mode are automatically calculated and set to the printer.

#AUTO BIDIR ADJUST  
#ADJ L ZZ >+0

ZZ: print head

---

#### Note

- **Be sure to confirm the adjustment value after pressing OK key, even when the value is 0. If OK key is not pressed, the results automatically calculated from the adjustment value are not applied.**

**Lower layer menu: #ADJ R Enter the bidirectional adjustment value for the right side.**

<Parameter (numeral input)>  
Range:-15to+15



**HINT**

- After entering this adjustment value, parameters for each print mode are automatically calculated and set to the printer.

#AUTO BIDIR ADJUST  
#ADJ R ZZ >+0

ZZ: print head



---

#### Note

- **Be sure to confirm the adjustment value after pressing OK key, even when the value is 0. If OK key is not pressed, the results automatically calculated from the adjustment value are not applied.**



**(4) MANUAL BIDIR ADJUST**

Press  and  keys to select the bidirectional adjustment pattern to print (upper layer menu), and confirm with  key. Then, select and confirm the lower layer menu.

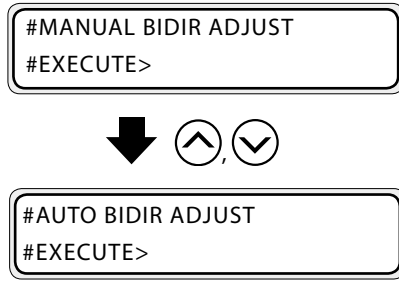

**Lower layer menu: #EXECUTE: Print the selected bidirectional adjustment pattern.**

<Parameter (execution)>  
 NONE

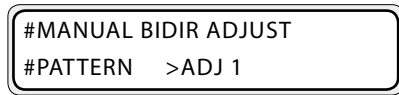

**Lower layer menu: #PATTERN Select the print mode to print the bidirectional adjustment pattern.**

<Parameter (selection)>	
ADJ1	Select to print in high speed and normal modes.
ADJ2	Select to print in high quality mode.
ADJ3	Select to print in max quality mode.

**Lower layer menu: #ADJ XX: Enter the bidirectional adjustment value.**

<Parameter (numeral input)>  
 Range:-15to+15

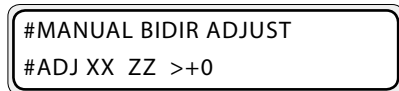

- When performing MANUAL BIDIR ADJUST, ADJ 1L, ADJ 1R, ADJ 2L, ADJ 2R, ADJ 3L and ADJ 3R must be set.

ZZ: print head  
 XX: 1L/1R/2L/2R/3L/3R

---

## REWIND MENU

While you keep pressing  key, the media is being rewound.

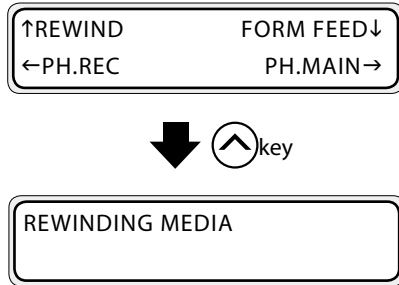

Release  key to stop the media. The printer returns to the offline state (menu mode).

**PH.REC MENU**

This is used to perform the print head cleaning. Press  key to enter the PH.REC MENU.

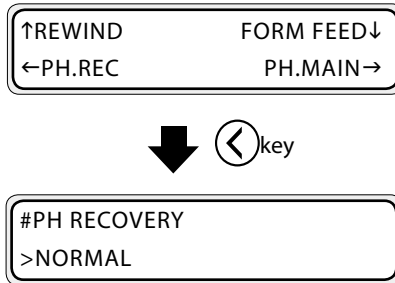

<Parameter (selection)>

NORMAL	Recover clogged nozzles.
STRONG	Recover clogged nozzles when not fixed with [NORMAL].

For details about the cleaning operation, refer to **[Section 4 Print head cleaning]** ( **P.4-24**).

---

## FORM FEED MENU

While pressing

 key, the printer keeps feeding the media. (In case of a sheet media, the paper is ejected.)

---

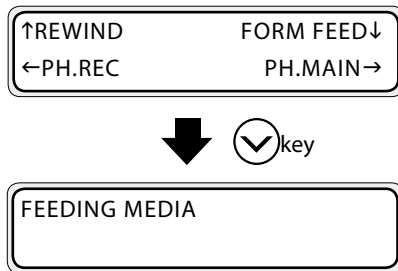

Release  key to stop the media. The printer returns to the offline state (menu mode).

## PH.MAIN MENU

This menu is used to perform maintenance and replacement of the capping unit and wiper blade, and the cleaning of the ink circuit. Press  key to enter the PH.MAIN MENU.

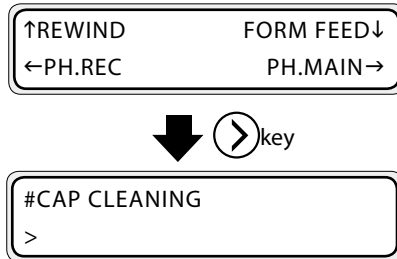

### (1) Cap cleaning

The carriage moves to the maintenance area so that the capping unit periodic cleaning can be performed.

 **P.4-6 [Clean the capping unit]**



<Parameter (execution)>

NONE

---

### (3) Service

Execute the service (cleaning) operation.

#INK SYSTEM OPT  
>STORE INK SYS

<Parameter (selection)>

STORE INK SYS	Clean the print head and ink circuit with storage liquid, then fill it with storage liquid so that the printer can be left for a long period of time.
CLEAN INK SYS	When using the printer after has been switched off for a long period of time after a service clean, clean the print head and ink circuit with cleaning liquid.
CHARGE INK SYS	Used this when filling the printer with the ink after performing a print head cleaning.
CHARGE CAP CL	Used to fill the cap with wiper cleaning liquid and soak the print heads (nozzle surface) in the liquid in order to fix the clogged nozzles. The printer should not be used for 12 to 18 hours (one night) after performing CHARGE CAP CL.
PURGE INK SYS	Used to purge the ink.

### (4) REPLACE WIPER BLADE

Used to replace the wiper blade.

 P.4-26 [Wiper blade replacement]

#REPLACE WIPER BLADE  
>

### (5) REPLACE WIPE LIQUID

Used to replace the wiper cleaning liquid.

 P.4-28 [Wiper cleaning liquid replacement]

#REPLACE WIPE LIQUID  
>

### (6) REPLACE WIPER SPONGE

Used to replace the Wiper sponge.

 P.4-30 [Wiper sponge replacement]

#REPLACE WIPE SPONGE  
>

**(7) Fill Cap**

This function fills the cap with ink so that the print heads (nozzle surface) are covered with ink and clogged nozzles are cleared. Leave the printer 1 to 2 hours and check the condition again.

Use this function if a print misses problem is not solved even after several cleaning.



#WASH PRINTHEADS  
>

<Parameter (execution)>

NONE

**Note**

- **Always perform a cleaning (normal) before printing after executing the fill cap.**
- **If the print misses (clogged nozzles) problem is not solved after leaving the printer for 24 hours, execute the smart nozzle mapping (nozzle map) function. If the problem remains, contact your dealer or a service representative. (  P.3-53 [(1) Nozzle print])**

**(8) PH HEIGHT ADJ**

Used to adjust the print head height.

(  P.2-28 [Change the print head height])



#PH HEIGHT ADJ  
>

**(9) RESEAT PRINT HEAD**

Used to check the print head connection.

Check any poor contact with the connector following the message instructions.



#RESEAT PRINTHEAD  
>

---

## PRINTER MENU

Use the following when executing the functions provided in the printer.  
Press  key to enter the PRINTER MENU.

---

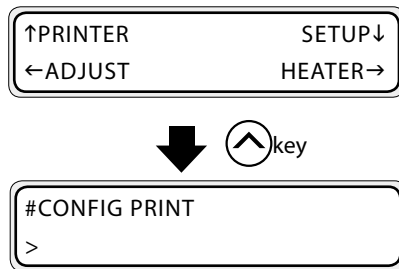

### (1) Menu print

This function prints the printer information and panel setting information.

#CONFIG PRINT  
>

<Parameter (execution)>

---

NONE

### (2) Error log print

This function prints the error log information saved in the printer.

#ERROR LOG PRINT  
>

<Parameter (execution)>

---

NONE

### (3) History print

This function prints the ink system cleaning status and the log of print head replacement.

#HISTORY PRINT  
>

<Parameter (execution)>

---



NONE



## ADJUST MENU

Use this function when setting the mechanical adjustment parameters. Press  key to enter the ADJUST MENU



Press  and  keys to select the print pattern (upper layer menu), and confirm with  key.

Press  key to start printing.

Press  key to stop the printing.

### (1) NOZZLE PRINT

Prints the nozzle check pattern (without cleaning). Use it for daily inspection.



**#EXECUTE: perform the nozzle print.**

<Parameter (execution)>

NONE

Set the number of the clogged nozzles.

**#Nozzle map: Enter the number of the clogged nozzles.**

<Parameter (numeral input)>

Range:0to254

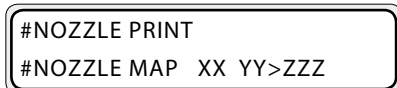

XX: Number (01 to 10)

YY : Ink color

Display order: Y → M → C → K → Lm → Lc  
<With neon ink>

Display order: Y → M → C → K → Np → Ny

ZZZ: Number of clogged nozzle

Refer to  **P.4-9** to confirm the number of the clogged nozzles.

---

## (2) NOZZLE POS ADJ

Prints the nozzle position adjustment pattern.  
(Use for maintenance.)

```
#NOZZLE POS ADJ  
#EXECUTE>
```

## (3) PRINT HEAD ADJUST

Prints the head position adjustment pattern.

```
#PRINT HEAD ADJUST  
#EXECUTE>
```

**#EXECUTE: Prints the head position adjustment pattern.**

<Parameter (execution)>  
NONE

Adjusts the head position (print position in the right and left direction of the media) of primary printing direction of each print head. Enter the adjustment value based on the result of [PRINT HEAD ADJUST] print.

---

### Note

- **The K color print head is used a reference. Therefore, there is no adjustment value for K.**

**#POS ADJ: Enter the head position adjustment value.**

<Parameter (numeral input)>  
±, -15 to +15

```
#PRINT HEAD ADJUST  
#POS ADJ YY >+0
```

YY : Ink color  
Display order: Y → M → C → K → Lm → Lc  
<With neon ink>  
Display order: Y → M → C → K → Np → Ny

Adjusts the application position of right and left nozzles for each print head. Enter the adjustment value based on the result of [PRINT HEAD ADJUST] print.

**#R/L ADJ: Enter the head position adjustment value.**

<Parameter (numeral input)>  
±, -5 to +5

```
#PRINT HEAD ADJUST  
#R/L ADJ YY >+0
```

YY : Ink color  
Display order: Y → M → C → K → Lm → Lc  
<With neon ink>  
Display order: Y → M → C → K → Np → Ny

(4) **EDGE SENSOR ADJUST**

Prints the sensor position adjustment pattern.

```
#EDGE SENSOR ADJUST
#EXECUTE>
```

**#EXECUTE: Prints the sensor position adjustment pattern.**

<Parameter (execution)>

NONE

Adjust the position of the printed drawing on the media. Enter an adjustment value based on the result of [EDGE SENSOR ADJUST] pattern print.

Refer to  **P.4-50** for details about sensor adjustment.

**#TOP ADJ: Enter the adjustment value for the media advance direction (top direction).**

```
#EDGE SENSOR ADJUST
#TOP ADJ >+0.0mm
```

<Parameter (numeral input)>

-5.0 to +5.0mm

**Note**

- **The entered value is in millimeter regardless of the [LENGTH UNITS] setting in the SETUP MENU.**

Adjust the position of the printed drawing on the media. Enter an adjustment value based on the result of [EDGE SENSOR ADJUST] pattern print.

**#SIDE ADJ: Enter the adjustment value for the media width direction (side direction).**

```
#EDGE SENSOR ADJUST
#SIDE ADJ >+0.0mm
```

<Parameter (numeral input)>

-5.0 to +5.0mm

**Note**

- **The entered value is in millimeter regardless of the [LENGTH UNITS] setting in the SETUP MENU.**

---

(5) **TUR ADJ PRINT**

Prints the take-up reel unit adjustment pattern.

```
#TUR ADJ PRINT  
#EXECUTE>
```

**#EXECUTE: Prints the TUR adjustment pattern.**

<Parameter (execution)>

NONE

## SETUP MENU

Use this when setting or displaying the system parameter. Press  key to enter the SETUP MENU.

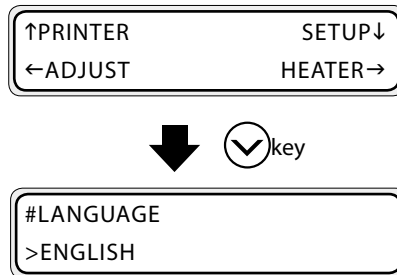

### (1) LANGUAGE

Select the language for LCD message.

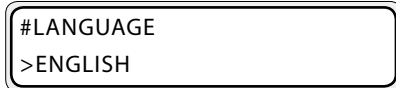

<Parameter (selection)>

JAPANESE	The LCD messages are displayed in Japanese.
ENGLISH	The LCD messages are displayed in English.
FRENCH	The LCD messages are displayed in French.
ITALIAN	The LCD messages are displayed in Italian.
GERMAN	The LCD messages are displayed in German.
SPANISH	The LCD messages are displayed in Spanish.
PORTUGUESE	The LCD messages are displayed in Portuguese.

### (2) Time Zone

Select the time zone.

When changing the time zone, the local time displayed is updated.

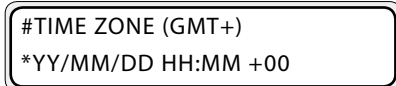

YY: Year MM: Month DD: Day HH: Hour MM: Minute  
YY/MM/DD HH: MM:  
The date and time that are calculated by adding the internal time (Greenwich Mean Time=GMT) to the time zone time are displayed.

<Parameter (selection)>

- 12 to +12	Selection input of a total of 25 stages for every hour.
-------------	---

---

### (3) Length Unit

Select the displayed length unit for various parameters.

#LENGTH UNITS

>MILLIMETER

<Parameter (selection)>

MILLIMETER	This displays in the meter unit system of mm (millimeter) or m (meter).
------------	---

INCH	This displays in the inch unit system of" (inch) or ft (feet).
------	--

### (4) Temperature Unit

Select the temperature unit.

#TEMPERATURE UNITS

>CENTIGRADE

<Parameter (selection)>

CENTIGRADE	Displays the temperature in centigrade.
------------	---

FAHRENHEIT	Displays the temperature in fahrenheit.
------------	---

### (5) BEEP

This function sets whether or not the warning beep sounds in the condition below.

- When the print heads are outside the cap during daily maintenance or height adjustment.
- Print heads cannot be capped due to media jam during printing.
- When confirming the print heads are checked.
- When the nest (origin) is being set.

#BEEP

>ON

<Parameter (selection)>

ON	The beep sounds.
----	------------------

OFF	The beep does not sound.*
-----	---------------------------

\* Regardless of this setting, the beep sounds when a normal error occurs.

**(6) BOOT Version**

Displays the BOOT version.

```
#BOOT VERSION
*X.XX
```

```
<Parameter (execution)>
NONE
```

**(7) F/W version**

Displays the version of system F/W.

```
#PRINTER FW VER
*X.XX_YY
```

```
<Parameter (execution)>
NONE
```

**(8) LEE version**

Displays the version of the LEE board.

```
#MAIN PCA VER
*X.XX
```

```
<Parameter (execution)>
NONE
```

**(9) LEC version**

Displays the version of the LEC board.

```
#CARRIAGE PCA
*X.XX
```

```
<Parameter (execution)>
NONE
```

**(10) BTC version**

Displays the BTC version.

```
#BTC version
#XXX
```

```
<Parameter (execution)>
NONE
```

---

**(11) ATG version**

Displays the ATG version.

#ATG version  
#XXX

<Parameter (execution)>

NONE

**(12) RSM version**

Displays the RSM version.

#RSM version  
#XXX

<Parameter (execution)>

NONE

**(13) PTG version**

Displays the PTG version.

#PTG version  
#XXX

<Parameter (execution)>

NONE

**(14) USB address**

Displays the USB address.

#USB ADDRESS  
>

<Parameter (execution)>

NONE



### (15) USB speed

Displays the transfer speed of USB connection.

#USB SPEED  
\*HIGH-SPEED

<Parameter (execution)>

HIGH-SPEED	USB connection in HIGH-SPEED.
FULL-SPEED	USB connection in FULL-SPEED.

**Note**

- Only displays the current connection state. In this menu, the transfer speed cannot be selected.

### (16) Initial setting

Sets all of the parameters to their initial default settings.

#FACTORY DEFAULT  
>

<Parameter (execution)>

NONE	
------	--

**Note**

- The printer must be rebooted after setting the initial setting.

### (17) Update

Use to update the firmware.

#PRINTER FW UPGRADE  
>

<Parameter (execution)>

NONE	
------	--

**Note**

- The printer must be rebooted after the firmware update.

## HEATER MENU

Use to set the heater delay time and heater standby time. Press  key to change the heater settings.

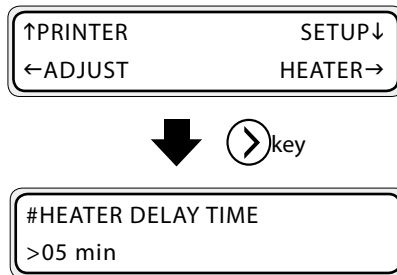

### (1) HEATER DELAY TIME

Sets the time before the heater turns off after printing is completed. (👉 P.2-25)

#HEATER DELAY TIME  
>05 min

<Parameter (numeral input)>

00 to 30

### (2) HEATER STANDBY TIME

Sets the time that the heater maintains the standby temperature after printing is completed. (Transition time to the standby temperature is included) (👉 P.2-25)

#HEATER STANDBY TIME  
>30 min

<Parameter (selection)>

NONE	Does not maintain the standby temperature.
30 min	Maintains the standby temperature for 30 minutes.
60 min	Maintains the standby temperature for 1 hour.
90 min	Maintains the standby temperature for 1 hour and a half.
120 min	Maintains the standby temperature for 2 hours.
CONTINUOUS	Continues to maintain the standby temperature.

# 4

## *Maintenance and Adjustment / Replacement*



This section describes the maintenance and adjustment of the printer and the replacement of consumables. (For replacement of ink cartridge, waste ink bottle and media, refer to **[Section 2 Basic Operation]**).

---

(Content of this section)

Periodic maintenance.....	4-2
Print head cleaning .....	4-24
Wiper blade replacement.....	4-26
Wiper cleaning liquid replacement .....	4-28
Wiper sponge replacement.....	4-30
Media advance value setting.....	4-32
Head position adjustment.....	4-41









# Periodic maintenance

This section explains the periodic inspection and periodic maintenance procedures.



## Periodic inspection and maintenance guide

This printer needs to be periodically inspected and maintained. For each periodic inspection and maintenance, refer to the pages described below and perform the described tasks properly.

### Regular Inspection / Maintenance (Daily maintenance)

- (1) Check the waste ink bottle  P.4-3
- (2) Check the remaining wiper cleaning liquid  P.4-3
- (3) Check stains on the wiper blade  P.4-4
- (4) Clean the capping unit  P.4-6
- (5) Clean the print head [normal]  P.4-8
- (6) Execute a the nozzle print  P.4-8
- (7) Fix missing print (clogged nozzle)  P.4-10
- (8) Maintenance for lengthy printing (more than 20 m)  P.4-10



### When the printer has been left switched off for an extended period (less than 2 weeks)

- (1) Head wash  P.4-17
- (2) Ink filling  P.4-17

### When leaving the printer switched off for more than 2 weeks

- (1) Service clean  P.4-15

### When the printer has been left switched off for more than 2 weeks

- (1) Head wash  P.4-16
- (2) Ink filling  P.4-16

### When the printer has been left switched off for more than 1 month

The service call error is displayed. Contact your dealer or the nearest service representative.

## ■ Regular Inspection / Maintenance (Daily maintenance)

To keep the print quality stable, perform regularly the following 6 maintenance items.

- |   |                 |
|---|-----------------|
| (1) Check the waste ink bottle                        | : everyday      |
| (2) Check the wiper cleaning liquid                   | : everyday      |
| (3) Check stains on the wiper blade                   | : everyday      |
| (4) Clean the capping unit                            | : every week    |
| (5) Execute the head cleaning [normal]                | : every week    |
| (6) Execute a nozzle print                            | : everyday      |
| (7) Fix missing print (clogged nozzle)                | : when occurred |
| (8) Maintenance for lengthy printing (more than 20 m) | : when required |

### Note

- Perform the maintenance tasks mentioned above within the indicated period.
- Only use the cleaning liquid, cleaning stick, cleaning roller and cleaning swab specified by OKI Data Infotech.
- When (4) in the list above is done, perform also (5) after that.
- Missing print may occur when the capping unit is dirty. If missing print cannot be recovered, execute (4) and (5) above.

### (1) Check the waste ink bottle

Check that the waste ink bottle is not full. When the waste ink is filled to the [FULL] label, replace the waste ink bottle with a new (empty) one.

(☞ P.2-40[Waste ink bottle replacement])

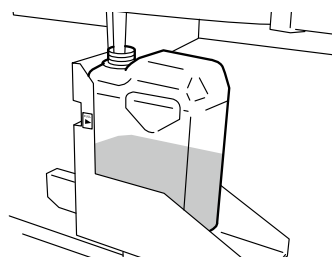

### (2) Check the remaining wiper cleaning liquid

Open the front cover and the cap cover and visually check the remaining wiper cleaning liquid. If the wiper cleaning liquid is empty, replace it.

(☞ P.4-28[Wiper cleaning liquid replacement])

The wiper cleaning liquid needs replacement about once a month as a general rule.

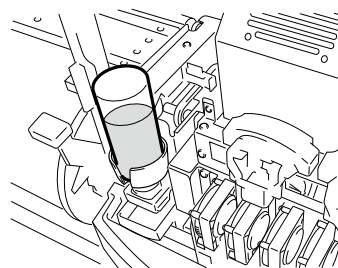

### Note

- The wiper cleaning liquid may get dirty. This is normal.

### (3) Check for stains on the wiper blade

Visually check for stains and damage on the wiper blade.

If damaged, replace the wiper blade. (☞ P.4-26[Wiper blade replacement])

- 1** Set the printer to offline. Press **MENU** key to display PH.MAIN MENU.



- 2** Press **>** key to enter the PH.MAIN MENU. The cap cleaning menu is displayed.



- 3** Select [REPLACE WIPER BLADE] with **✓** key and press **OK** key.



- 4** When the confirmation menu appears, press **OK** key. The position of the wiper blade changes.

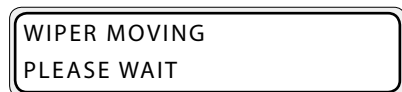

- 5** Open the front cover and the cap cover.

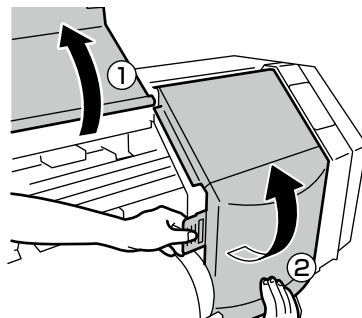

**6** Visually check for stains and damage on the wiper blade.

If damaged, replace the wiper blade.  
(☞ P.4-26[Wiper blade replacement])

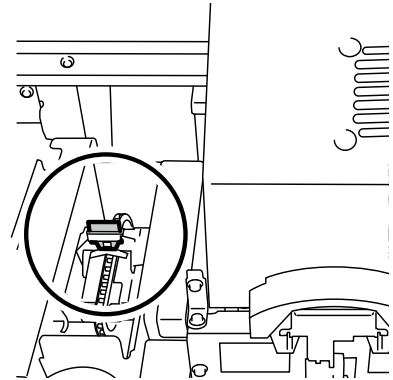

**Note**

- If the wiper blade is dirty, check visually that the wiper sponge is properly installed. If not set properly, set it correctly.  
(☞ P4-30[Wiper sponge replacement])
- Check the level in the wiper cleaning liquid bottle. If it is low, replace the wiper cleaning liquid.(☞ P.4-28[Wiper cleaning liquid replacement])

**7** Close the cap cover and the front cover.

#REPLACE FINISHED  
\*NO

**8** Select [\*NO] and press **OK** key to finish.

**Note**

- The printer automatically calculates the wiper blade usage time and displays the message prompting to replace the wiper blade when necessary. If a new wiper blade is installed and [\*YES] is set, the counted value is reset. Reset the count only when necessary to avoid replacement time calculation errors.

#### (4) Clean the capping unit

- 1 Install a cleaning roller on a cleaning stick

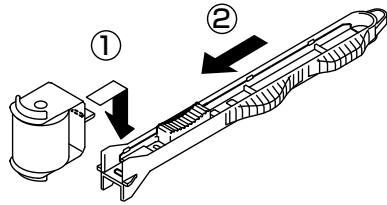

- 2 Set the printer to offline and press **MENU** key to display PH.MAIN MENU.



- 3 Press **→** key to enter in PH.MAIN MENU. The cap cleaning menu is displayed.



- 4 Press **OK** key. When the confirmation menu appears, press **OK** key again. The carriage moves.

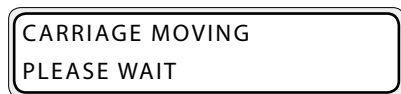
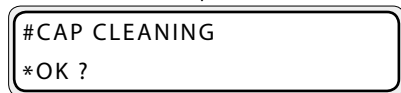

**HINT** - When the carriage moves, the warning beep sounds. (☞ P.3-58[(5) BEEP])

- 5 Open the front cover and then the cap cover.

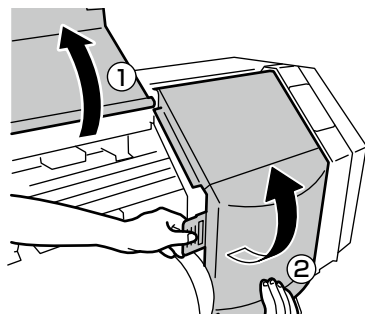



- 6** Dip the cleaning roller in the cap cleaning liquid.

**Note**

- Do not dip a cleaning roller once used for cleaning in the cap cleaning liquid bottle. The cap cleaning liquid will get dirty.

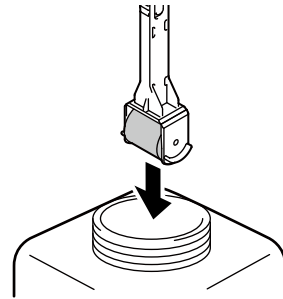

- 7** Clean on the surface of the cap by rolling the cleaning roller.

1. First, roll the cleaning roller on each cap, going back and forth once.

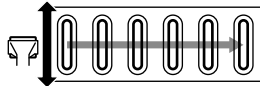

2. Next, roll the cleaning roller on each 30 times.

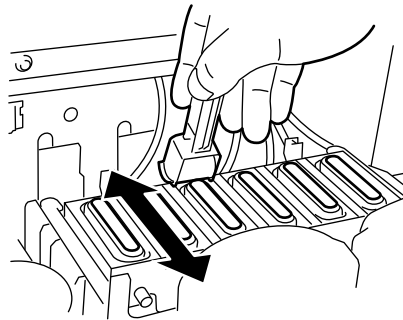
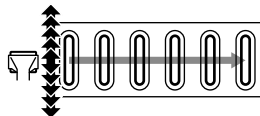

**HINT**

- Caps may also be cleaned using the cleaning swabs (thick) sold separately.

**Note**

- The cleaning roller is intended for a single use only. Use a new cleaning roller for each cleaning.
- If the caps are still dirty after cleaning, take a new cleaning roller and perform cleaning again.
- With the 4 color specifications, the 2 caps on the left side do not require to be cleaned.

- 8** Close the cap cover and the front cover.

The carriage automatically returns to the original position.

**Note**

- Do not expose the print heads for an unnecessarily long time when taking them out of the capping unit. The print heads may dry and cause malfunction.
- After cleaning, if print defects still occur, remove foreign matters and ink stains on the cap with the cleaning swab soaked with cap cleaning liquid while checking visually.
- Be careful not to put cap cleaning liquid on parts of the printer other than the cap.

---

### (5) Execute the print head cleaning [NORMAL]

Select PH.REC MENU from the operation panel and then [NORMAL] to perform the cleaning. (☞P.4-24[Print head cleaning])

### (6) Execute a nozzle print

The nozzle print is performed to confirm that the nozzles of the print head are not blocked. Before printing each day or after cleaning the caps, run the nozzle print to verify the print head performance.

- 1** Set the printer to offline. (Press **ONLINE** key.)

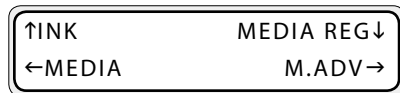

- 2** Press **MENU** key twice to display ADJUST MENU.

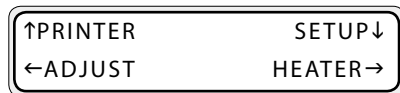

- 3** Press **←** key to display the nozzle print.



- 4** Press **→** key.



- 5** Press **OK** key.



- 6** Press **OK** key.



- 7** When pressing **OK** key, after performing the warm-up, the adjustment pattern shown in the next page is printed.

- Print Sample [Nozzle print]  
(When using neon ink, Ny and Np are displayed in place of Lc and Lm respectively.)

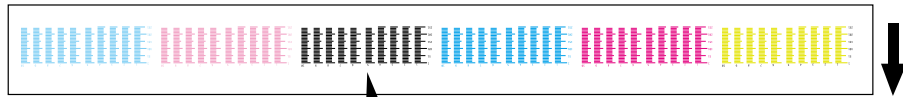

Media advance direction

**OK** No line is missing and the printout is correct

Mark for the last nozzle (nozzle 254) Check that nozzle print is complete up to the right of this mark.

**NG** Missing lines are found

Example when lines for nozzles 24 and 133 are missing in the printout.

**OK** No line is bent and the printout is correct

If the spaces between the lines are even, no line is bent.

**NG** Bent lines are found

If there are uneven spaces between lines, some lines may be bent.

The line printed by the nozzle 159 (indicated with the arrow) is bent to the nozzle 161.  
⇒ The nozzle 159 prints bent lines.

Confirm that all nozzles are operating correctly. If print defects are found on the nozzle print, perform **(5) Print head cleaning [NORMAL]** again. If print defects still occur after several print head cleanings, perform settings for NOZZLE MAP (☞P.3-53[(1) Nozzle print])

**Note**

- Do not expose the print heads for an unnecessarily long time when taking them out of the capping unit.  
**Finish the work quickly and cap the print heads.**



- Nozzle map (smart nozzle mapping) is a function used to prevent print quality degradation when an identified nozzle is blocked. Generally, when only one nozzle is blocked, the print quality is not affected. However, when 2, 3 or more nozzles are blocked, the print quality is affected and the expected results may not be obtained. The smart nozzle mapping function compensates the print defects due to a blocked nozzle by using another nozzle. Contact a service representative if you are not able to compensate all print defects using this function.

---

## (7) Fix missing print (clogged nozzle)

If missing prints still appear after executing the daily maintenance and setting nozzle map, perform the following actions.



- Missing print may occur when the capping unit is dirty. If missing print cannot be recovered, clean the capping unit and perform **NORMAL** cleaning.

### Strong cleaning

Perform the strong cleaning when the missing dots persist after the normal cleaning.



Perform the **NOZZLE PRINT**

### Fill the cap with ink

To clear the nozzle clogging, fill the cap with ink and moisten the print head nozzle surface with ink. After this operation, hold the Printer for 1 to 2 hours. Then perform **NORMAL** cleaning.



Perform the **NOZZLE PRINT**

### Fill the cap with wiper cleaning liquid

To clear the nozzle clogging, fill the cap with wiper cleaning liquid. After this operation, hold the Printer for 12 to 18 hours. Then perform **NORMAL** cleaning.

## (8) Maintenance for lengthy printing (more than 20 m)

After lengthy printing, dirt that cannot be removed through cleaning may adhere to the print heads (nozzle surface). To recover from this condition, execute **WASH PRINTHEADS**.

Through the **WASH PRINTHEADS** function, the caps are filled with ink to soak the print heads (nozzle surface) in ink and clear the clogged nozzle.

After this operation, leave the printer 1 to 2 hours.

Then perform **NORMAL** cleaning.

**Strong cleaning**

**1** Set the printer to offline. (Press **ONLINE** key.)



**2** Press **MENU** key to display PH.REC MENU.



**3** Press **←** key to enter in the head cleaning menu.



**4** To set the parameter, press **OK** key.



**5** Press **▽** key to select [\*STRONG].

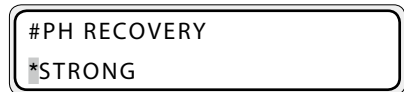

**6** Press **OK** key.



**7** Check visually that the waste ink bottle is not full and press **OK** key once again.



XXX : The time is counted down every 10 seconds.

**Note**

- **Cleaning takes several minutes.**
- **When the cleaning starts, a timer is displayed. The time decreases every 10 seconds.**

- 
- 8** When the print head cleaning finishes, the menu returns to the state in step **3**.

#PH RECOVERY  
>NORMAL

- 9** Press  key to return to the offline state (menu mode) display.

↑REWIND                  FORM FEED↓  
←PH.REC                  PH.MAIN→

### Fill the cap with ink

- 1** Set the printer to offline and press  key to display PH.MAIN MENU.

↑REWIND                  FORM FEED↓  
←PH.REC                  PH.MAIN→

- 2** Press  key to enter in PH.MAIN MENU. The cap cleaning menu is displayed.

#CAP CLEANING  
>

- 3** Press  key to select [#WASH PRINTHEADS].

#WASH PRINTHEADS  
>

- 4** Press  key.

#WASH PRINTHEADS  
\*OK?

- 5** Press  key.

#WASH PRINTHEADS  
\*EXECUTING

- 6** Leave the Printer for 1 to 2 hours.

After the Printer has been left for 1 to 2 hours, perform the normal cleaning.

**Fill the cap with wiper cleaning liquid**

**1** Set the printer to offline and press  key to display PH.MAIN MENU.



**2** Press  key to enter in PH.MAIN MENU. The cap cleaning menu is displayed.



**3** Press  key to select [>STORE INK SYS].



**4** Press  key.



**5** Press  key to select [\*CHARGE CAP CL].

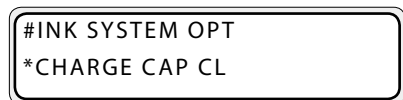

**6** Press  key.



**7** Check visually that the waste ink bottle is not full and press  key once again.

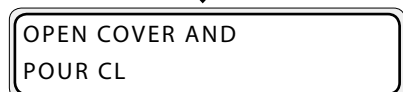

- 
- 8** Open the front cover, and then open the cap cover.

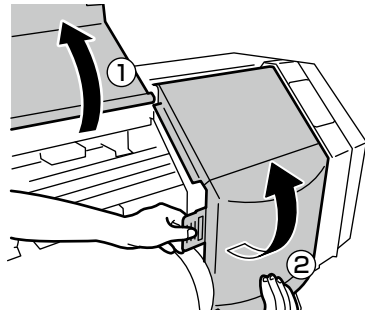

- 9** Add the wiper cleaning liquid to the cap.

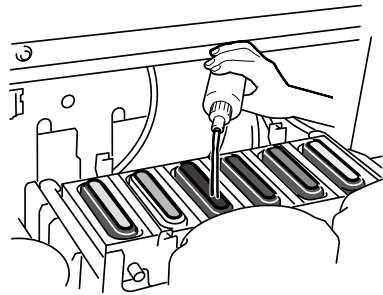

- 10** Close the capping cover and the front cover.

The carriage returns automatically to the home position.

- 11** Leave the Printer for 12 to 18 hours.

After the Printer has been left for 12 to 18 hours and before printing, perform the normal cleaning.



---

## ■ When leaving the printer switched off for more than 2 weeks

To prevent the print head from drying, it needs to be filled with storage liquid. 6 storage liquid cartridges are needed, one for each color (4 for the 4 color specifications). Prepare a storage liquid set (IP5-293). A storage liquid cartridge is fully used for one service cleaning.

### (1) Service clean

Select PH.MAIN MENU from the operation panel and then STORE INK SYS.



```
#INK SYSTEM OPT
>STORE INK SYS
```

After finishing the service clean, turn off the power of the printer while the cartridges of storage liquid are inserted in the ink cartridge slots. Then, leave the printer.

When re-using the printer after performing the service clean, a head wash is necessary. (☞P.4-16[(1)Head wash])

---

## ■ When the printer has been left switched off for more than 2 weeks

Clean the print head and the ink circuit using the cleaning liquid. Prepare the cleaning liquid cartridge set (IP5-294 for GX ink/IP5-298 for IX ink). A full cleaning liquid cartridge is used for one cleaning.

### (1) Head wash

Select PH.MAIN MENU from the operation panel and then CLEAN INK SYS. Follow the instructions on the LCD screen.



#INK SYSTEM OPT  
>CLEAN INK SYS

After the head wash, perform the ink filling so that all color inks are filled.

---

#### Note

- **To protect the print head, the printer automatically fill the cap with ink at regular intervals.**
- **Refrain from opening or closing the front cover or moving the lever while executing the service clean or head wash. The operation may need to be started from the beginning and ink and the cleaning liquid will be wasted.**
- **Use the cleaning liquid cartridges designed for GX ink with neon ink. The cleaning liquid cartridges designed for IX ink cannot be used.**

### (2) Filling with ink after the head wash

After performing the head wash, the printer needs to be filled with all the inks. Select PH.MAIN MENU from the operation panel and then CHARGE INK SYS.



#INK SYSTEM OPT  
>CHARGE INK SYS

Insert all the ink cartridges before filling with the ink.

After filling with ink, leave the printer for at least 1 hour. Confirm that the wipe sponge is wet. If necessary, make it wet. Then, perform the nozzle print.

If print defects are found on the nozzle print, perform [PH RECOVERY [NORMAL]] from PH.REC MENU.

## ■ When the printer has been left switched off for less than 2 weeks

### (1) Head wash

Clean the print head and the ink circuit using the cleaning liquid. Prepare the cleaning liquid cartridge set (IP5-294 for GX ink/IP5-298 for IX ink). A full cleaning liquid cartridge is used for one cleaning. After the head wash, perform the ink filling so that all color inks are charged.

#### Note

- **To protect the print head and the ink circuit, do not leave the ink container of the printer empty without filling it with ink or storage liquid.**
- **Refrain from opening or closing the front cover or moving the pressure lever while executing the service clean or head wash. The operation may need to be started from the beginning and ink and the cleaning liquid will be wasted.**
- **When leaving the printer for a long time after switching it off, the maintenance differs depending on the period. In case of more than 2 weeks, the printer is left after being filled with storage liquid. In case of less than 2 weeks, leave the printer filled with inks .**
- **Use the cleaning liquid cartridges designed for GX ink with neon ink. The cleaning liquid cartridges designed for IX ink cannot be used.**

### (2) Filling with ink after the head wash

After performing the head wash, the printer needs to be filled with all the inks. Select PH.MAIN MENU from the operation panel and then CHARGE INK SYS.

#INK SYSTEM OPT  
>CHARGE INK SYS

#### Note

- **The ink charge operation used about 100 ml of ink. If a cartridge containing less than 100 ml of ink is inserted, the message prompting to replace the ink cartridge is displayed. Use ink cartridges with at least 20% of ink remaining.**

Insert all the ink cartridges before filling with the ink.

After filling with ink, leave the printer for at least 1 hour. Then, perform the nozzle print.

If print defects are found on the nozzle print, perform [PH RECOVERY [NORMAL]] from PH.REC MENU.

---

## ■ When the printer has been left switched off for more than 1 month

Even if the service clean has been performed, a service call error is displayed.  
Contact your dealer or a service representative.

---

### Note

- **To protect the print head and the ink circuit, do not leave the ink container of the printer empty without filling it with ink or storage liquid.**
- **When leaving the printer for more than 1 month, consult your dealer or a service representative in advance.**

## Cleaning

### ■ Clean the exterior

If the printer exterior is stained, moisten a soft cloth with water or water-diluted neutral detergent, wring it and wipe out stains.

#### Note

- **When cleaning, ensure to turn off the power of the printer.**
- **Never use volatile solvent such as thinner and benzene. Paint may come off or be discolored.**

### ■ Clean the front cover, paper guide, pressure roller and edge guard

If the printer is soiled with paper particles or dust, remove them using a vacuum cleaner. If the printer is stained with ink, wipe out the ink stains with a soft cloth moistened with neutral detergent.

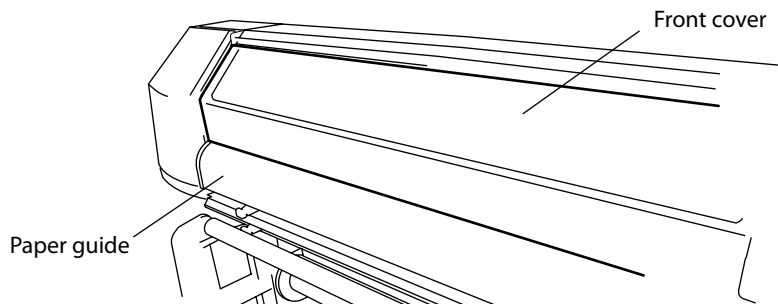

#### Note

- **When cleaning, be sure to turn off the power of the printer.**
- **Do not blow out paper particles. If paper particles or dust get inside the printer, it may cause malfunction or affect the print quality.**
- **When using media with adhesive applied to the core at the end of the roll, this adhesive may stick to the paper guide or the platen. In this case, always clean up the adhesive.**

---

## ■ Cleaning the platen

Use the following procedure to clean the platen if

- vinyl chloride adhesive gets on the platen
- ink drops on the platen (The procedure to clean ink stains is explained)

- 1** Open the front cover and soak up the ink on the platen with a piece of waste media.

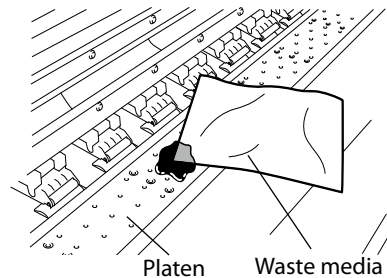

- 2** Wipe the ink stains off the platen with a soft cloth moistened with a neutral detergent.

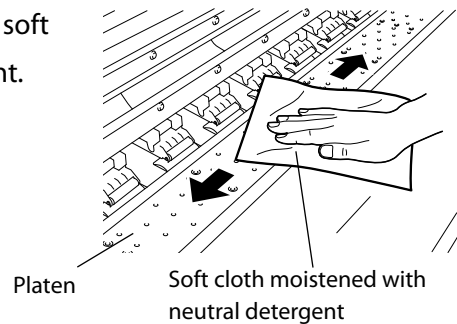

- 3** If the ink penetrates into the vacuum hole on the platen, wipe out the ink stuck in the hole with a commercially available cotton swab\*. Then, moisten the cotton swab with neutral detergent and wipe out once more.

**\*: Use a cotton swab with a tip of 3 mm diameter.**

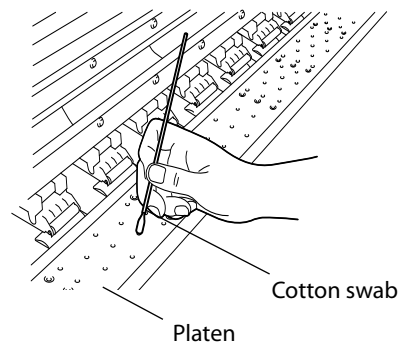

■ Cleaning the carriage base

When dirt on the carriage base contacts the media, and black lines appears on the print, clean the carriage base using the following procedure.

- 1** Set the printer to offline. Press **(MENU)** key to display PH.MAIN MENU.



- 2** Press **(▶)** key to enter the PH.MAIN MENU. The cap cleaning menu is displayed.



- 3** **(▼)** Select [RESEAT PRINTHEAD] with **(OK)** key and then press key.



- 4** When the confirmation menu appears, press **(OK)** key. The carriage moves.



- 5** Open the front cover and then the maintenance cover.



- 6** Wipe clean the carriage base with a soft cloth.

After finishing the cleaning, close the maintenance cover and the front cover.

The carriage automatically returns to its original position.

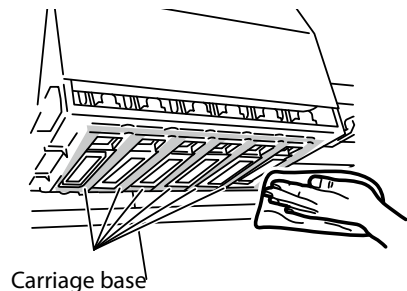

**Note**

- Do not expose the print heads for an unnecessarily long time when taking them out of the capping unit. The print heads may dry and cause malfunction.

---

## ■ Clean the head guard

When dirt on the head guard contacts the media, and black lines appears on the print, clean the head guard using the following procedure.

- 1** Set the printer to offline. Press **MENU** key to display PH.MAIN MENU.



- 2** Press **▶** key to enter the PH.MAIN MENU.  
The cap cleaning menu is displayed.



- 3** **▼** Select [RESEAT PRINTHEAD] with **OK** key and then press key.



- 4** When the confirmation menu appears, press **OK** key.  
The carriage moves.



- 5** Open the front cover and then the maintenance cover.





- 6** Dip the cleaning swab in the cap cleaning liquid and remove the dirt on the right and left head guards of the carriage. Visually check the result and leave it for few minutes.

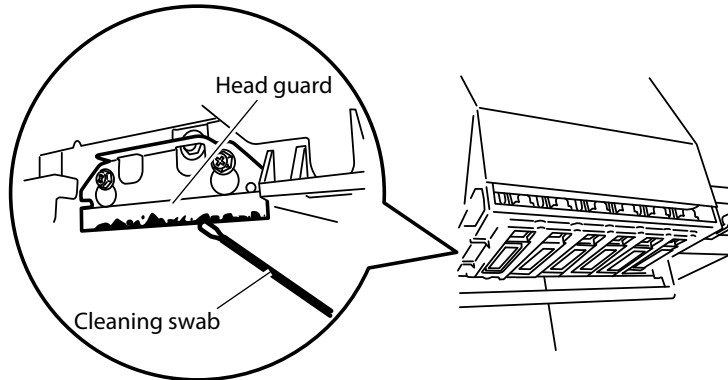

**Note**

- Do not dip a cleaning roller swab once used in the cap cleaning liquid bottle. The cap cleaning liquid will get dirty.

- 7** Wipe out stains with a soft cloth.
- After finishing the cleaning, close the maintenance cover and the front cover. The carriage automatically returns to its original position.

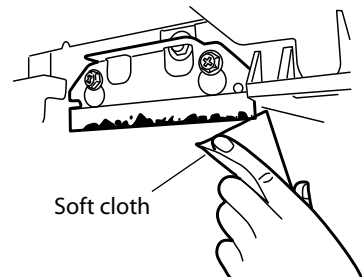

**Note**

- Do not expose the print heads for an unnecessarily long time when taking them out of the capping unit. The print heads may dry and cause malfunction.

# Print head cleaning

There are two types of print head cleaning as shown below. Use the suitable one.

Type of cleaning	Usage
NORMAL	Recovery of clogged nozzles
STRONG	Recovery of clogged nozzles when not fixed with [NORMAL]

## Operating procedure of print head cleaning

- 1** Set the printer to offline. (Press **ONLINE** key.)



- 2** Press **MENU** key to display PH.REC MENU.

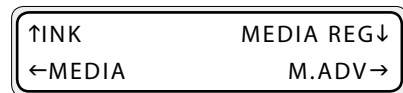

- 3** Press **←** key to enter in the head cleaning menu.

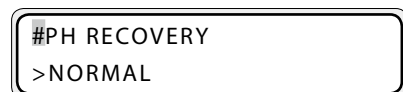

- 4** To set the parameter, press **OK** key.

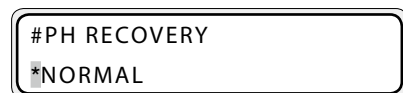

- 5** Select the option for cleaning with **↑**, **↓** keys.

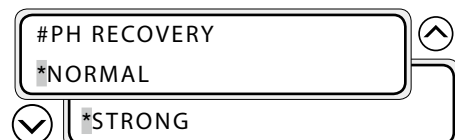

**6** Press **OK** key.

#PH RECOVERY  
\*BOTTLE OK ?

**7** Check visually that the waste ink bottle is not full and press **OK** key once again.

#PH RECOVERY  
\*CLEANING XXX

XXX : The time is counted down every 10 seconds.

**Note**

- **Cleaning takes several minutes.**
- **When the cleaning starts, a timer is displayed. The time decreases every 10seconds.**

**8** When the print head cleaning finishes, the menu returns to the state in step **3**.

#PH RECOVERY  
>NORMAL

**9** Press **←** key to return to the offline state (menu mode) display.

↑REWIND      FORM FEED↓  
←PH.REC      PH.MAIN→

# Wiper blade replacement

This section describes the wiper blade replacement procedure. Replace the wiper blade when the printer displays the replacement message or when damage is found on the wiper blade during a daily inspection. Before replacement, prepare the tweezers (packed in the daily maintenance kit).

- 1** Set the printer to offline. Press **MENU** key to display PH.MAIN MENU.



- 2** Press **>** key to enter the PH.MAIN MENU. The cap cleaning menu is displayed.



- 3** Select [REPLACE WIPER BLADE] with **↓** key and press **OK** key.



- 4** When the confirmation menu appears, press **OK** key. The position of the wiper blade changes.



- 5** Open the front cover and the cap cover.

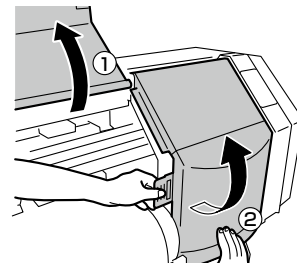

- 6** Pinch the lower edge of the wiper blade with the tweezers and pull out the plastic protrusion.

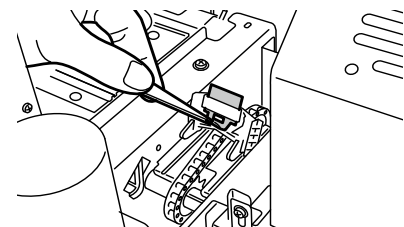

- 7** Remove the wiper blade while lifting upward.

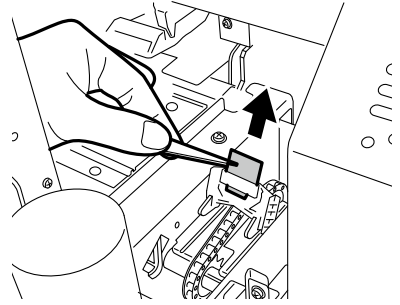

- 8** Pinch the rubber portion of a new wiper blade with the tweezers and insert the wiper blade straight from the top. Install it so that the plastic protrusion fits into the hole of the rubber portion.

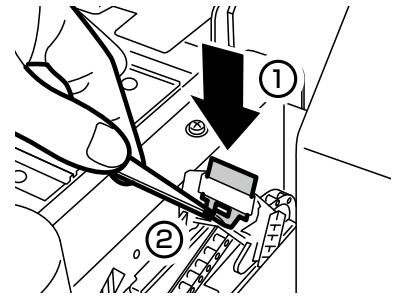

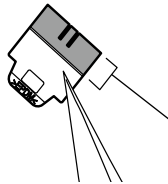

**Note**

- The front and back of the wiper blade are the same.
- As the upper portion of the wiper blade touches directly the print head, do not touch it with hands or pinch it with the tweezers when handling.



Upper portion of the wiper blade

- 9** Close the cap cover and the front cover.
- 10** Select [\*YES] with  key and press  key to finish.

#REPLACE FINISHED  
\*NO

#REPLACE FINISHED  
\*YES

**Note**

- The printer automatically calculates the wiper blade usage time and displays the message prompting to replace the wiper blade when necessary. If a new wiper blade is installed and [\*YES] is set, the counted value is reset. Reset the count only when necessary to avoid replacement time calculation errors.

# Wiper cleaning liquid replacement

This section describes the wiper cleaning liquid replacement procedure. Replace the wiper cleaning liquid when the printer displays the replacement message or when you notice that the remaining wiper cleaning liquid is low during a daily inspection. The wiper cleaning liquid needs replacement about once a month as a general rule.

- 1** Set the printer to offline. Press **MENU** key to display PH.MAIN MENU.



- 2** Press **▶** key to enter the PH.MAIN MENU. The cap cleaning menu is displayed.



- 3** Select [REPLACE WIPE LIQUID] with **▼** key and press **OK** key.



- 4** When the confirmation menu appears, press **OK** key.



- 5** Open the front cover and the cap cover.

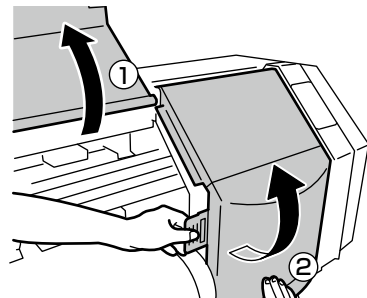

- 6** Raise up the old wiper cleaning liquid bottle a little and pull out the bottle after making sure that all the liquid has flowed into the printer

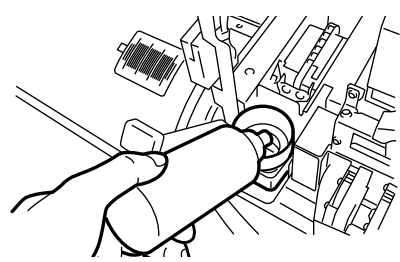

**Note**

- Visually check that the waste ink bottle is not full before removing.

- 7** Replace the cap of the new wiper cleaning liquid bottle with the printer set dedicated cap.

Printer set cap

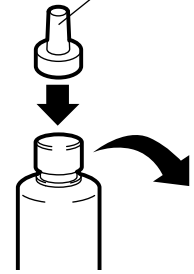

- 8** Set the wiper cleaning liquid bottle in the printer and push in the stopper of the printer set cap by pressing the top.

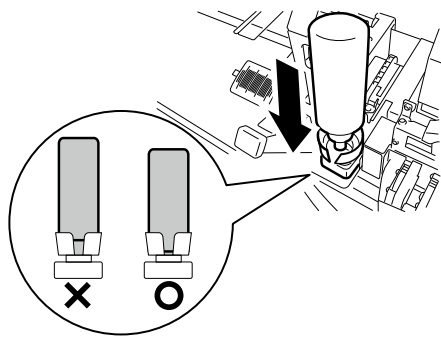

- 9** Close the cap cover and the front cover.



- 10** Select [\*YES] with key and press key to finish.



**Note**

- The printer automatically calculates the wiper cleaning liquid usage and displays the message prompting to replace the wiper cleaning liquid bottle when necessary. If a new wiper cleaning liquid bottle is installed and [\*YES] is set, the counted value is reset. Reset the count only when necessary to avoid replacement time calculation errors.
- The wiper cleaning liquid may get dirty. This is normal.

# Wiper sponge replacement

This section describes the wiper sponge replacement procedure.

Replace the wiper sponge when the printer displays the replacement message.

The wiper sponge needs replacement about once every six months as a general rule.

- 1** Set the printer to offline. Press **MENU** key to display PH.MAIN MENU.

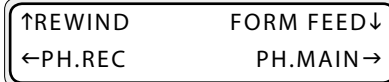

- 2** Press **>** key to enter the PH.MAIN MENU. The cap cleaning menu is displayed.



- 3** Select [REPLACE WIPE SPONGE] with **↓** key and press **OK** key.



- 4** When the confirmation menu appears, press **OK** key.



- 5** Open the front cover and the cap cover.

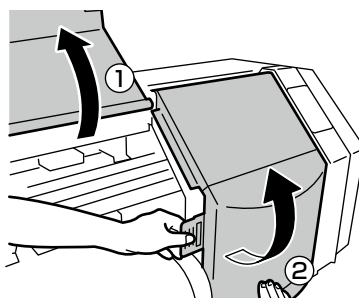

- 6** Raise up the wiper cleaning liquid bottle a little and pull out the bottle after making sure that all the liquid has flowed into the printer.

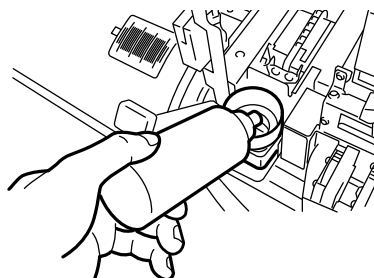

## Note

- Visually check that the waste ink bottle is not full before removing.



- 7** Lift the wiper sponge little by little while drawing it toward you. After confirming that the liquid in the wiper sponge has completely flowed in the printer, remove the wiper sponge.

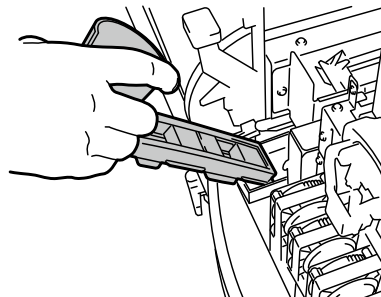

- 8** Install a new wiper sponge.  
Insert it as far as it goes until it clicks.

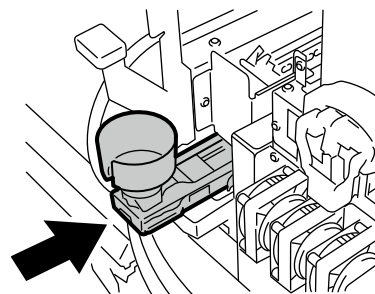

- 9** Install a new wiper cleaning liquid bottle.  
(☞P.4-28[Wiper cleaning liquid replacement])

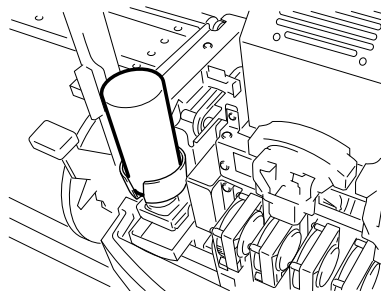

- 10** Close the cap cover and the front over.

- 11** Select [\*YES] with  key and press  key to finish.



**Note**

- The printer automatically calculates the wiper sponge usage time and displays the message prompting to replace the wiper sponge when necessary. If a new wiper sponge is installed and [\*YES] is set, the counted value is reset. Reset the count only when necessary to avoid replacement time calculation errors.

# Media advance value setting

The media advance characteristics vary depending on the thickness, elasticity and surface frictional resistance of the media. If the media advance value is not appropriate, banding (horizontal stripes) may appear on the print. Use the following procedure to set the appropriate media advance value.

Step 1  
Print the adjustment pattern

Step 2  
Reading the print result of the adjustment pattern,  
Enter the media advance value.



The following factors affect the media advance value:

- Type of media
- Print mode
- Smart pass setting
- Pressure change using the pressure roller up/down lever
- Use of the take-up reel unit
- Media advance mode (FWD ONLY/BACK & FWD)

## Media advance value setting procedure

### 1 Set media wider than A1 size in width and longer than 1 m in length.

The media advance value can be determine using both the single and the multi advance adjustment patterns.

With SING. ADV, printing is performed with the current ADJ VALUE (one pattern).

With MULTI ADV, printing is performed with the current ADJ VALUE - 0.2%, the current ADJ VALUE and the with the current ADJ VALUE + 0.2% (3 patterns).

When the take-up reel unit is set to the tension winding, the print length becomes longer.

(To stop the printing of the advance adjustment pattern, press **CANCEL** key.)

### With single pattern

### 2 Set the printer to offline. (Press **ONLINE** key.)

↑INK	MEDIA REG↓
←MEDIA	M.ADV→

### 3 Press **➤** key to display SING. ADV.

#SING. ADV
#EXECUTE>

- 4** Press **(>)** key to select the pattern to print (SING. ADV).

```
#SING. ADV:100.00%
#EXECUTE>
```

- 5** With **(^)** and **(v)** keys, select the print mode and smart pass, and specify the settings you want to adjust.

```
#SING. ADV
#PRINT MO.>NORMAL
```

```
#SING. ADV
#SMART PA.>LOW
```

- 6** With **(^)** and **(v)** keys, select EXECUTE and press **(OK)** key.

The single pattern is printed with the selected print mode and smart pass.

```
#SING. ADV:100.00%
#EXECUTE>
```

- 7** Press **(OK)** key to input the adjustment value. Set the adjustment value with **(^)** and **(v)** keys, then press **(OK)** key.

```
#SING. ADV:100.00%
#ADJ VALUE      *100.20%
```

The current adjustment value is displayed on the top and the value being changed on the bottom.

- 8** Press **(OK)** key to display the confirmation screen.

```
#SING. ADV:100.20%
#ADJ VALUE      *OK ?
```

- 9** Press **(OK)** key.

```
#SING. ADV:100.20%
*EXECUTING
```

- 10** Check the print result. If the adjustment value does not seem appropriate, repeat the steps 6 to 9 to determine the correct value.

Confirm the adjustment value and start printing.

## With multi patterns

- 1** Set the printer to the offline.

(Press **ONLINE** key.)

```
↑INK          MEDIA REG↓  
←MEDIA      M.ADV→
```

- 2** Press **➤** key to display MULTI ADV.

```
#MULTI ADV  
#EXECUTE>
```

- 3** Press **➤** key to select the pattern to print (MULTI ADV).

```
#MULTI ADV:100.00%  
#EXECUTE>
```

- 4** With **▲** and **▼** keys, select the print mode and smart pass, and specify the settings you want to adjust.

```
#MULTI ADV  
#PRINT MO.>NORMAL
```

```
#MULTI ADV  
#SMART PA.>LOW
```

- 5** With **▲** and **▼** keys, select EXECUTE and press **OK** key. The multi patterns are printed with the selected print mode and smart pass.

```
#MULTI ADV:100.00%  
#EXECUTE>
```

- 6** Press **OK** key to input the adjustment value. Set the adjustment value with **▲** and **▼** keys, then press **OK** key.

```
#MULTI ADV:100.00%  
#ADJ VALUE      *100.20%
```

The current adjustment value is displayed on the top and the value being changed on the bottom.

- 7** Press **OK** key to display the confirmation screen.

```
#MULTI ADV:100.20%  
#ADJ VALUE      *OK ?
```

- 8** Press **OK** key.

```
#MULTI ADV:100.20%  
*EXECUTING
```

Confirm the adjustment value and start printing.

- 9** Check the print result. If an adjustment value seems more appropriate than the current, enter this value. If the adjustment values does not seem appropriate, repeat the steps 6 to 9 to determine a correct value.

 **HINT** How to read the advance adjustment pattern

(When using neon ink, Ny and Np are displayed in place of Lc and Lm respectively.)

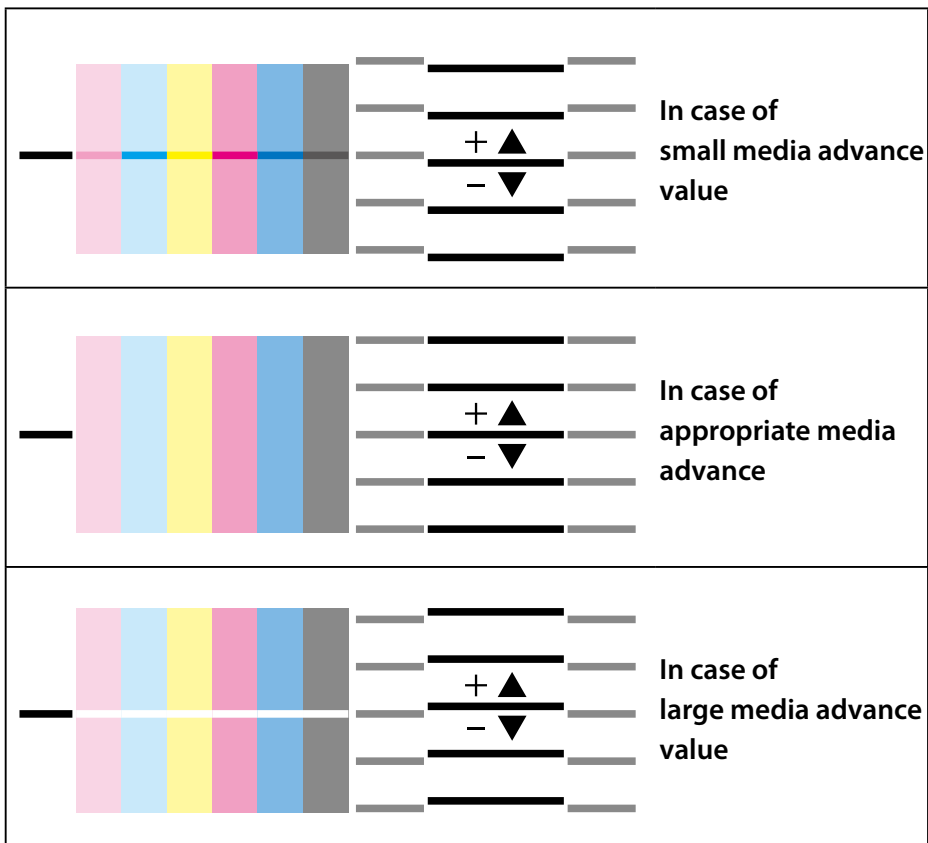

#### Note



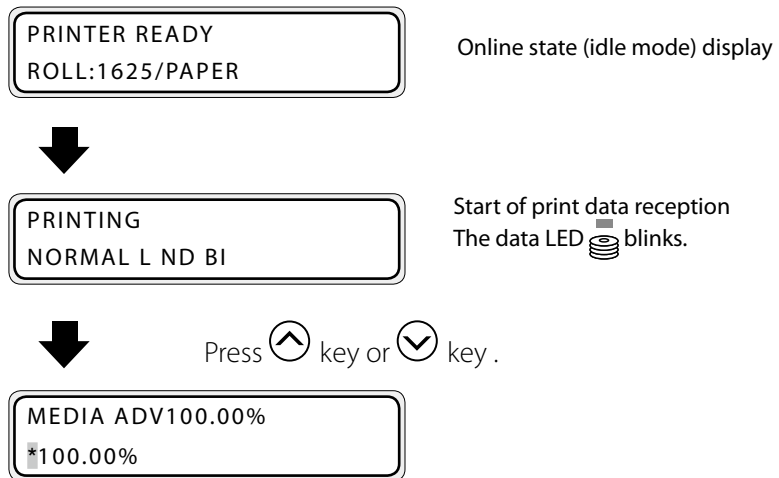

- When the appropriate media advance value differs for each print head (each color), enter the average value. However, if a color has the priority in a printed image, enter the media advance value specific to that color.
- If the appropriate media advance value differs at the right and left of media, enter the average value.
- If the appropriate media advance value at the right side of media is different from that at the left side, it may be caused by media inclination. Check that the media is set straight.

## Change during online printing

During online printing, the media advance value can be changed using the following procedure.



### HINT

- By pressing  key or  key during printing, the currently used media advance value is displayed. (Second row on the display)
- The value at the beginning of printing is displayed on the first row on the display and remains unchanged until printing is finished.
- The value increases or decreases by 0.01 % when pressing  or  keys.
- When the value is changed, it is reflected on printing immediately.
- If no key is operated for 3 seconds, the display returns to the original display.
- Since the changed media advance value is saved as a new value, it is also reflected on the next print.

## Change the media type registered without setting the media again

**HINT**

- The following modifies the media advance value.

- 1** Press **ONLINE** to put the printer offline.
- 2** Press **←** key to enter the MEDIA menu.
- 3** Press **▽** key several times to select [#MEDIA TYPE]. Then press **OK** key.
- 4** Press **▽** key several times to select the media you want to set.
- 5** Press **OK** key.

↑INK	MEDIA REG↓
←MEDIA	M.ADV→

ROLL (XXXXXX)
YYYYmm

#MEDIA TYPE
>01:PAPER



#MEDIA TYPE
*01:PAPER



#MEDIA TYPE
*04:BANNER



#MEDIA TYPE
>04:BANNER

---

## Adjust the margin to the previous printout before printing

During preheating before a print starts, the margin to the previous printout can be adjusted by feeding and rewinding the media.



**HINT**

- Once the printing process (scanning) starts, this function cannot be used for the job.

**1** Press **ONLINE** key during preheating before the print starts.

PREHEATING  
MAX-QUA L ND UNI

**2** When the printing pauses, press and hold  key.

PRINTER PAUSED  
ROLL:1626/PAPER

**3** Release the key to stop media feeding.

FEEDING MEDIA

**4** Press **ONLINE** key to resume printing.

PRINTER PAUSED  
ROLL:1626/PAPER



PREHEATING  
MAX-QUA L ND UNI



**HINT**

- The media can be rewound by pressing  key.



## Set the edge guards again during printing

If the edge guards separate from the media or foreign matter is present in the media path during printing (online state), it may be necessary to open the front cover. The front cover can be opened and closed during printing by temporarily suspending the printing.

- 1** Press **ONLINE** key during printing.



PRINTING  
MAX-QUALNDUNI

- 2** After the printing process suspends, open the front cover.

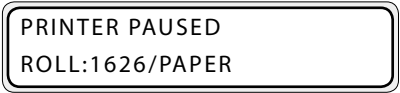

PRINTER PAUSED  
ROLL:1626/PAPER

- 3** Close the front cover. The panel returns to the printing paused display.



CLOSE COVER

- 4** Press **ONLINE** key to resume printing.

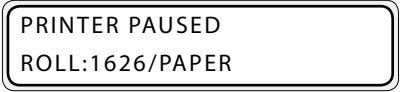

PRINTER PAUSED  
ROLL:1626/PAPER



**ONLINE**



PRINTING  
MAX-QUALNDUNI

---

## Remove media wrinkles during printing

If the media wrinkles during printing (online state), the grip on the media can be released after printing has been suspended.



**HINT**

- Releasing the grip can reduce media wrinkles but it may also affect print quality as the media may skew.

**1** Press **ONLINE** key during printing.

PRINTING  
MAX-QUA L ND UNI

**2** Release the grip after the printing process has been suspended.

PRINTER PAUSED  
ROLL:1626/PAPER

---

**Note**

- **After the grip has been released, hold the media with your hands to prevent it from skewing.**

**3** Apply the grip again. The panel returns to the printing paused display.

APPLY GRIP



**4** Press **ONLINE** key to resume printing.

PRINTER PAUSED  
ROLL:1626/PAPER



PRINTING  
MAX-QUA L ND UNI

# Head position adjustment

Print the pattern for adjusting the print position of each print head and enter the correction value.

## When replacing the media with a new media

(1) Adjustment of bidirection position (P.4-42 Bidirectional adjustment method)

Print the adjustment pattern  
[AUTO/MANUAL BIDIR ADJUST].



Based on the result of the adjustment pattern print,  
enter the value in  
[BIDIR ADJ L] or [BIDIR ADJ R].

(2) Adjustment of media advance value (P.4-32 [Media advance value setting])

Print the adjustment pattern  
[SING./MULTI ADV].



Based on the result of the adjustment pattern  
print, enter the value in  
[MEDIA ADV VALUE].

## To get a good printed image quality (normally, the adjustment is not necessary.)

(1) Adjustment of the print position in vertical directions

Print the adjustment pattern  
[NOZZLE POS ADJ].



Based on the result of the adjustment pattern print,  
enter the value in [NOZZLE POS VAL].

(2) Adjustment of the print position in the right and left directions

Print the adjustment pattern  
[PRINT HEAD ADJUST].



Based on the result of the adjustment pattern print,  
enter the value in [POS ADJ].



Based on the result of the adjustment pattern print,  
enter the value in [R/L ADJ].

(3) Adjust the position of the picture being printed on the media (only when the head (K) is replaced)

Print the adjustment pattern  
[EDGE SENSOR ADJUST].



Based on the result of the adjustment pattern print,  
enter the value in [TOP ADJ] and [SIDE ADJ].

## BIDIRECTIONAL ADJUSTMENT method

### (With auto bidirectional adjustment)

Adjust the bidirection position of each head. Enter an adjustment value based on the result of AUTO BIDIR ADJUST print.

### **STEP 1** *How to print the adjustment pattern [AUTO BIDIR ADJUST]*

- 1** Set the printer to offline. (Press **ONLINE** key.)

↑INK MEDIA REG↓  
←MEDIA M.ADV→

- 2** Press **➤** key to enter M.ADV MENU.

#SING. ADV  
#EXECUTE>

- 3** Press **⏴** key to select [AUTO BIDIR ADJUST] and press **➤** key.

#AUTO BIDIR ADJUST  
#EXECUTE>

- 4** **OK** Presskey. The adjustment pattern shown in the figure below is printed.

#AUTO BIDIR ADJUST  
\*EXECUTING

[AUTO BIDIR ADJUST] print sample  
(When using neon ink, Ny and Np are displayed in place of Lc and Lm respectively.)

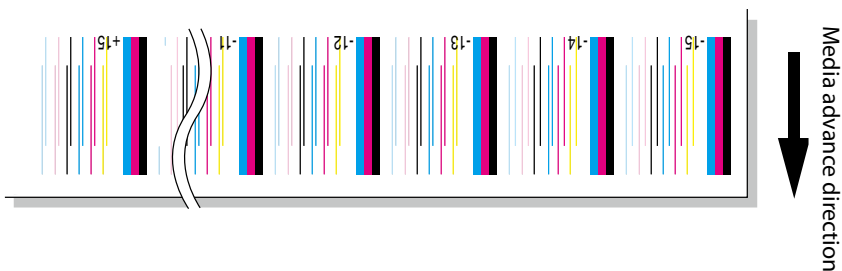

**STEP 2** *How to enter the adjustment value*

- 5** After selecting M.ADV MENU, press key to display [AUTO BIDIR ADJUST].

```
#AUTO BIDIR ADJUST
#EXECUTE>
```

- 6** Press key to move the cursor and and keys to select ADJ R or ADJ L.  
This is an example of the M (magenta) color print head adjustment.

```
#AUTO BIDIR ADJUST
#ADJ L M>+0
```

- 7** Press key to confirm the head color to be corrected and make it ready for entering the parameter.

```
#AUTO BIDIR ADJUST
#ADJ L M*+00
```

- 8** In the [AUTO BIDIR ADJUST] pattern, enter the number of the pattern where the two lines of each color print head are aligned in one.

Select the digit with , keys and change the value with , keys.

Enter the number of the pattern where the two lines are the closest.  
For example, when setting the M color print head, in "-12" in the figure to the right, the two lines are separated and in "-8" the two lines are aligned. So "-8" is the correct value.

```
#AUTO BIDIR ADJUST
#M:ADJ L M >-08
```

- 9** Press key.

```
#AUTO BIDIR ADJUST
#M:ADJ L M >-08
```

- 10** Adjust [ADJ R] using the same method.

- 11** Adjust other colors using the same method.

---

**(With manual bidirectional adjustment)**

Adjust the bidirection position of each head. Enter an adjustment value based on the result of MANUAL BIDIR ADJUST print.

**STEP 1 How to print the adjustment pattern [MANUAL BIDIR ADJUST]**

- 1** Set the printer to offline. (Press **ONLINE** key.)

↑INK                      MEDIA REG↓  
←MEDIA                      M.ADV→

- 2** Press **➤** key to enter M.ADV MENU.

#SING. ADV  
#EXECUTE>

- 3** Press **⏴** key to select [MANUAL BIDIR ADJUST] and press **➤** key.

#MANUAL BIDIR ADJUST  
#EXECUTE>

- 4** Press **⏴** key to select [PATTERN].

#MANUAL BIDIR ADJUST  
#PATTERN >ADJUST 1

- 5** Press **OK** key to change the print pattern.

#MANUAL BIDIR ADJUST  
#PATTERN \*ADJUST 1

- 6** Press **⏴** and **⏵** keys to select the pattern to print.

#MANUAL BIDIR ADJUST  
#PATTERN >ADJUST 2

Press **OK** key to confirm.

- 7** Press **⏴** key to select EXECUTE.

#MANUAL BIDIR ADJUST  
#EXECUTE>

- 8** (OK) Presskey. The adjustment pattern shown in the figure below is printed.

```
#MANUAL BIDIR ADJUST
*EXECUTING
```

[MANUAL BIDIR ADJUST] print sample

(When using neon ink, Ny and Np are displayed in place of Lc and Lm respectively.)

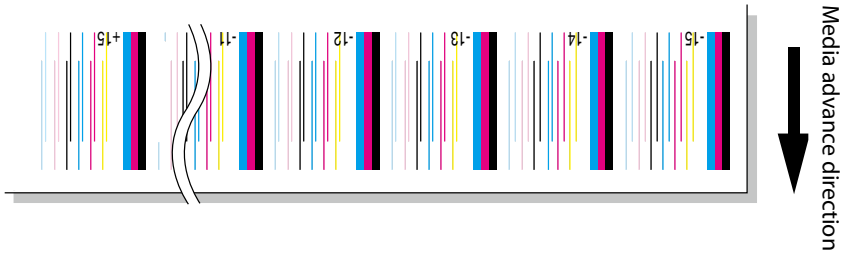

### STEP 2 How to enter the adjustment value

- 9** After selecting M.ADV MENU, press (V) key to display [MANUAL BIDIR ADJUST].

```
#MANUAL BIDIR ADJUST
#EXECUTE>
```

- 10** Press (R) key to move the cursor and (U) and (D) keys to select the ADJ VALUE to enter.

```
#MANUAL BIDIR ADJUST
#ADJ 2 L M>+0
```

This is an example of ADJ 2 L adjustment for the M (magenta) color print head.

- 11** Press (OK) key to confirm the head color to be corrected and make it ready for entering the parameter.

```
#MANUAL BIDIR ADJUST
#ADJ 2 L M*+00
```

- 12** In the [MANUAL BIDIR ADJUST] pattern, enter the number of the pattern where the two lines of each color print head are aligned in one.

Select the digit with (L), (R) keys and change the value with (U), (D) keys.

Enter the number of the pattern where the two lines are the closest.

For example, when setting the M color print head, in “-12” in the figure to the right, the two lines are separated and in “-8” the two lines are aligned. So “-8” is the correct value.

```
#MANUAL BIDIR ADJUST  
#M:ADJ 2 L M >-08
```

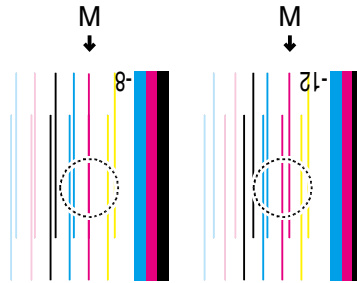

**13** Press **OK** key.

**14** Adjust [ADJ 2 R] using the same method.

```
#MANUAL BIDIR ADJUST  
#M:ADJ 2 L M >-08
```

**15** Adjust other colors using the same method.

**16** Adjust the other ADJ VALUE using the same method.



**[PRINT HEAD ADJUST] adjustment procedure**

Adjust the head position of each print head, using K color print head as a reference. Enter an adjustment value based on the result of [PRINT HEAD ADJUST] print.

**STEP 1 How to print the adjustment pattern [PRINT HEAD ADJUST]**

**1** Set the printer to offline. (Press **ONLINE** key.)



**2** Press **MENU** key twice to display ADJUST MENU.



**3** Press **←** key to enter ADJUST MENU.



**4** Press **↓** key, select [PRINT HEAD ADJUST] and press **→** key.



**5** Press **OK** key. The adjustment pattern shown in the figure below is printed.

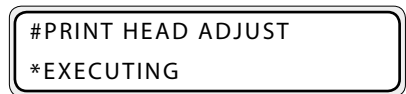

[PRINT HEAD ADJUST] print sample

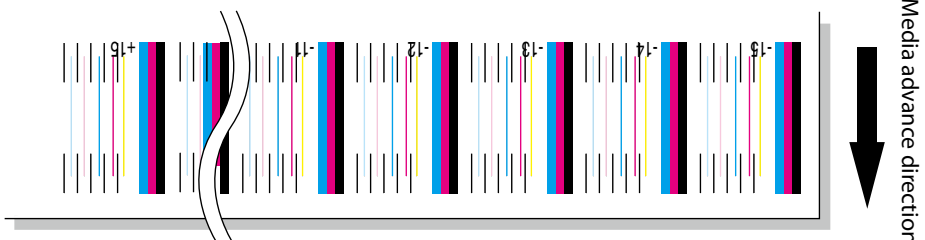

(When using neon ink, Ny and Np are displayed in place of Lc and Lm respectively.)



## STEP 2 How to enter the adjustment (position adjustment) value

- 6** After selecting ADJUST MENU, press  key to display [PRINT HEAD ADJUST].

```
#PRINT HEAD ADJUST
#EXECUTE>
```

- 7** Press  key to move the cursor and change the print head selection with ,  keys.





```
#PRINT HEAD ADJUST
#POS ADJ Lc
```

This is an example of the Lc (light cyan) color print head adjustment.  
Lc is replaced by Ny when using neon ink.

- 8** Press  key to confirm the print head color to be corrected and make it ready for entering the parameter.

```
#PRINT HEAD ADJUST
#POS ADJ Lc *+00
```

- 9** In [PRINT HEAD ADJUST] patterns, enter the number of the pattern with the line of the print head to be set the closest to the lines of the reference K print head.

Select the digit with ,  keys and change the value with ,  keys.  
When using neon ink, Ny and Np are displayed in place of Lc and Lm respectively.

For the correction value, enter the number of the pattern with the line matching the lines of the K color print head.  
For example, when setting the Lc color print head, in "-12" in the figure at the right hand side, the two lines are separated and in "+2", the two lines are aligned. Thus, enter "+2".

```
#PRINT HEAD ADJUST
#POS ADJ Lc >+02
```

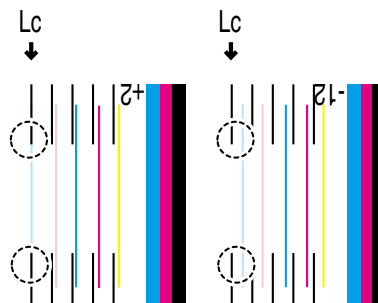

- 10** Press  key.



```
#PRINT HEAD ADJUST
#POS ADJ Lc >+02
```

- 11** Adjust other colors using the same method.

**STEP 3** *How to enter the adjustment (L to R adjustment) value*

- 6** After selecting ADJUST MENU, press  key to display [PRINT HEAD ADJUST].

```
#PRINT HEAD ADJUST
#EXECUTE>
```

- 7** Press  key to move the cursor and change the print head selection with ,  keys.





```
#PRINT HEAD ADJUST
#R/L ADJ M >+00
```

This is an example of the M (magenta) color print head adjustment.

- 8** Press  key to confirm the print head color to be corrected and make it ready for entering the parameter.

```
#PRINT HEAD ADJUST
#R/L ADJ M *+00
```

- 9** In the [PRINT HEAD ADJUST] pattern, enter the number of the pattern where the two lines of each color print head are aligned in one.

Select the digit with ,  keys and change the value with ,  keys. When using neon ink, Ny and Np are displayed in place of Lc and Lm respectively.

Enter the number of the pattern where the two lines are the closest.  
 For example, when setting the M color print head, in "-5" in the figure to the right, the two lines are separated and in "3", the two lines are aligned. So "3" is the correct value.

```
#PRINT HEAD ADJUST
#R/L ADJ M >+03
```

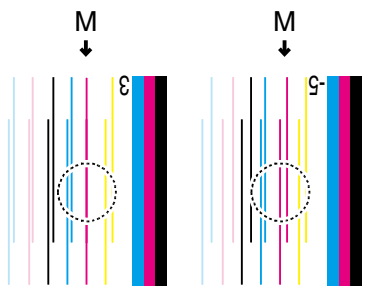

- 10** Press  key.

```
#PRINT HEAD ADJUST
#R/L ADJ M >+03
```

- 11** Adjust other colors using the same method.

## [EDGE SENSOR ADJUST] adjustment procedure

Adjust the print position on the media. Enter an adjustment value based on the result of [EDGE SENSOR ADJUST] print. This adjustment is required only when the K head is replaced.

### **STEP 1 *Cut the edge of the media set to the printer with the media cutter blade.***

#### Note

- Cut the edge of the media straight so that it is parallel to the platen. Without doing so, proper adjustment cannot be conducted.
- Do not use curled media as it may cause media jam.

### **STEP 2 *How to print the adjustment pattern [EDGE SENSOR ADJUST]***

- 1** Set the printer to offline. (Press **ONLINE** key.)

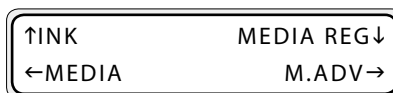

- 2** Press **MENU** key twice to display ADJUST MENU.



- 3** **←** Presskey to enter ADJUST MENU.



- 4** Press **▼** key to select [EDGE SENSOR ADJUST].



- 5** Press **OK** key.



- 6 Press **OK** key. The adjustment pattern shown in the figure below is printed.

#EDGE SENSOR ADJUST  
\*EXECUTING

[EDGE SENSOR ADJUST] print sample



• [TOP ADJ] measurement method

Measure the distance (margin) between the adjustment pattern and the cut edge of the media.

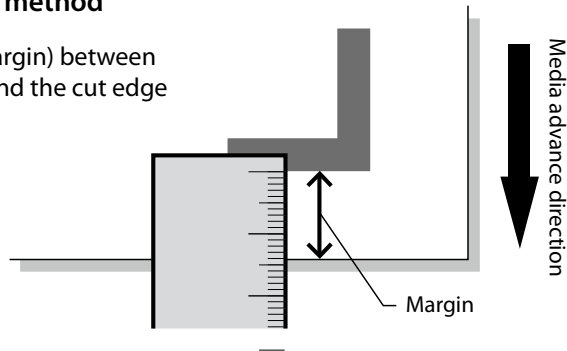

• [SIDE ADJ] measurement method

Measure the distance (margin) between the adjustment pattern and the side of the media.

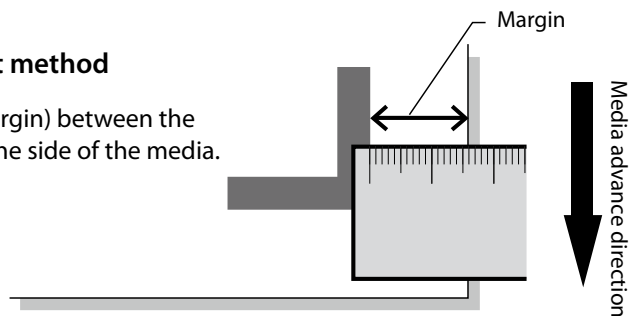

• Adjustment value determination method

Take **15mm** as a reference value to determine the adjustment value after measuring the margin.

<Example>

With a **14mm** margin: The adjustment value is **-1.0mm**.

With a **16mm** margin: The adjustment value is **+1.0mm**.

---















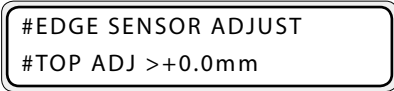

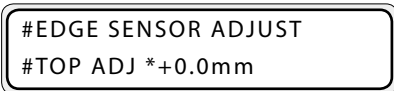

### **STEP 3 How to enter the adjustment value**

The example of a case with [TOP ADJ] at +1.0 mm and [SIDE ADJ] at -1.0 mm is described here.

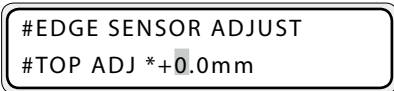
---

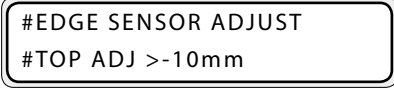
#### **Note**

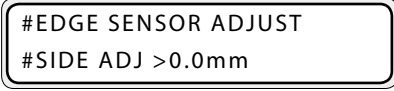
- **To activate the input adjustment value, the [EDGE SENSOR ADJUST] adjustment pattern must be re-printed and the media must be set again.**

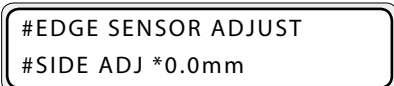
- 7** After selecting ADJUST MENU, press  key to display [EDGE SENSOR ADJUST].  
Press  key to move the cursor and  and  keys to select the TOP ADJ.
- 
- 
- 8** Press  key to make it possible to enter the parameter.
- 
- 9** Enter the adjustment value.  
Select the digit with ,  keys and change the value with ,  keys.  
For the method to determine the adjustment value, see  **P.4-51**.
- 
- 10** Press  key.
- 
- 11** Press  key to select SIDE ADJ.
- 
- 12** Press  key to make it possible to enter the parameter.
- 

**13** Enter the adjustment value.

Select the digit with ◀ ▶ keys and change the value with ▲ ▼ keys.

For the method to determine the adjustment value, see 🔑P.4-51.

#EDGE SENSOR ADJUST  
#SIDE ADJ >0.0mm

**14** Press **OK** key.

#EDGE SENSOR ADJUST  
#SIDE ADJ >+1.0mm





# 5

## *How to use options*

This section describes how to operate the option units.

---

(Content of this section)

How to use the take-up reel unit.....	5-2
Adjustment of the take-up reel unit.....	5-19
How to use the blower unit (option).....	5-23
Cut the media .....	5-25
Media cutter blade replacement .....	5-26

# How to use the take-up reel unit

The take-up reel unit is an optional unit. The IP-5620 and IP-5520 have both their dedicated unit.

Also, there are two types of take-up reel units as shown below.

In loose take-up mode, the method to set the media differs by take-up reel unit type.

Confirm the type of the take-up reel unit used with the figures below, and set the media using the corresponding method.

Type without rear sensor (IP-153/IP5-260)

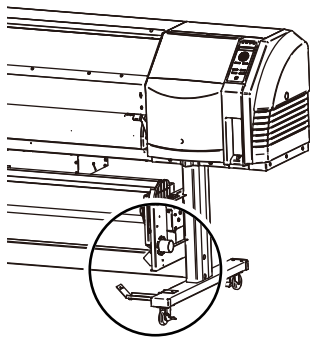

Type with rear sensor (IP5-268/IP5-269)

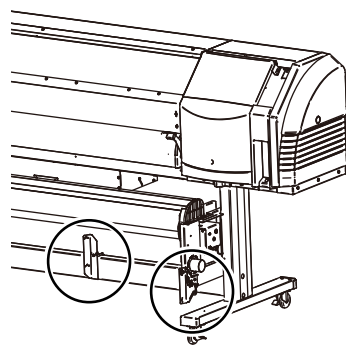

Unless otherwise specified, the figures shown in the section correspond to the type without rear sensor.

## Limitation regarding the type with rear sensor

The take-up reel unit type with rear sensor has the following limitation.

- Length limit of the paper tube for winding

Use a paper tube of more than 750 mm (30 inches) in length for winding.

(Example: Use a paper tube of 36 inches (914.4 mm) when rewinding a media of 24 inches (609.6 mm) in width.

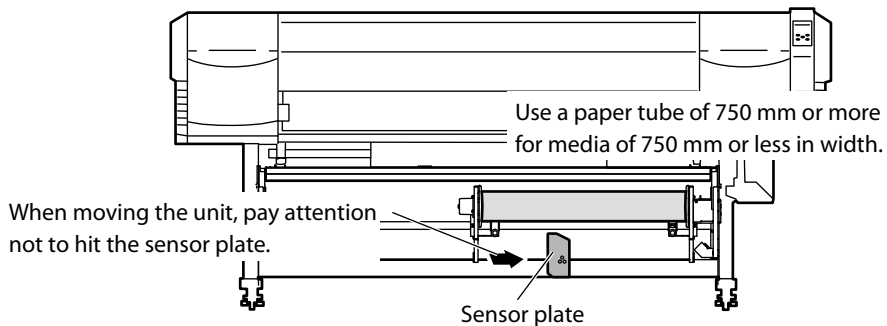

- Inner take-up cannot be used in loose mode.  
Use inner take-up or outer take-up in tension mode.

**Note**

- **With the take-up reel unit type without rear sensor, use a paper tube for winding of the same width as the roll media used for printing. Take-up shift may occur if a paper tube larger in width is used.**

**Install the media on the take-up reel unit**



**HINT**

- If a blower unit is used, move it to a place where it will not disturb the operation.

**1** Set the take-up switch to OFF.

Set the switch to the proper mode based of the figure below.

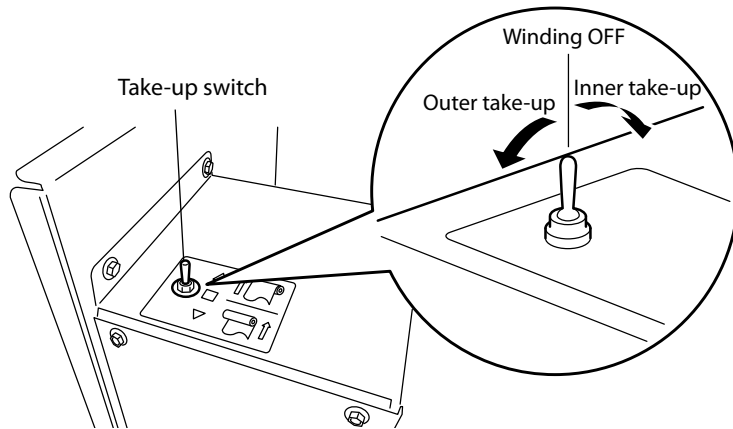

**2** Move the tension roller in the top position.

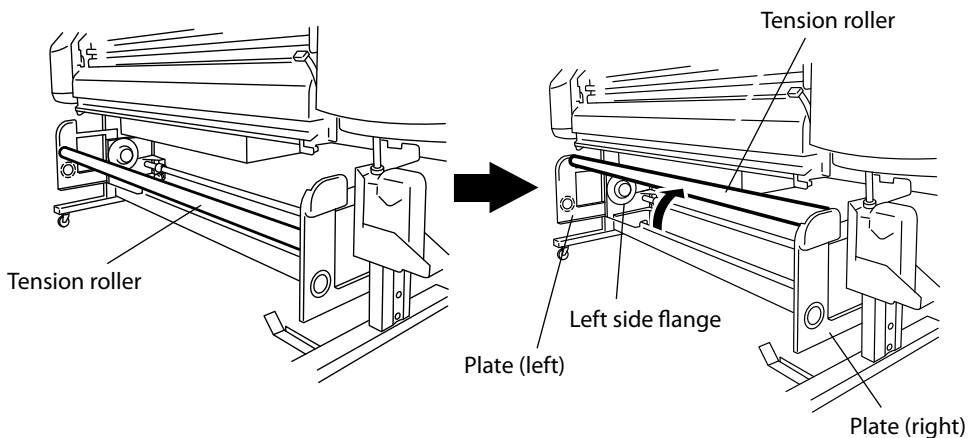

<Tension roller fixed position>

<Tension roller top position>

- 
- 3** Insert the paper tube in the right side flange (fixed side).

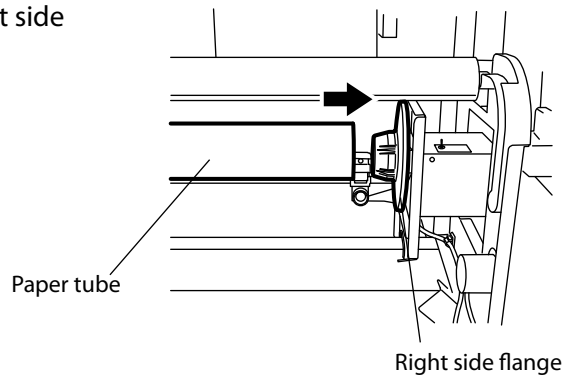

---

**Note**

- It is normally not necessary to move the position of the right side flange, it is used in the fixed position. However, when aligning with the roller media installation position to the printer, adjust the position of the right side flange.

- 4** Slide the left side flange (movable side) to insert it in the paper tube.

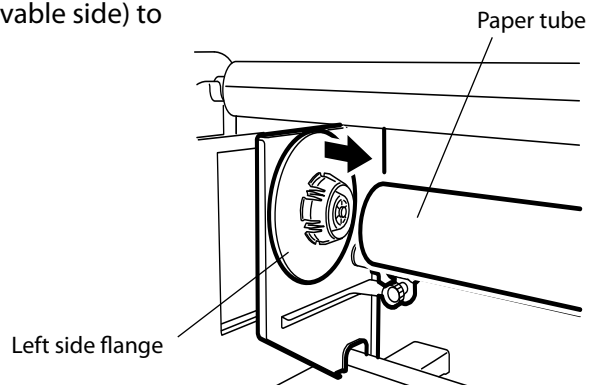

- 5** Tighten the knob at the left side firmly to secure the flange.

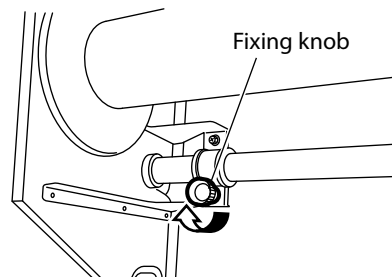

- 6** After setting the media, feed the media until its leading edge reaches the paper tube.

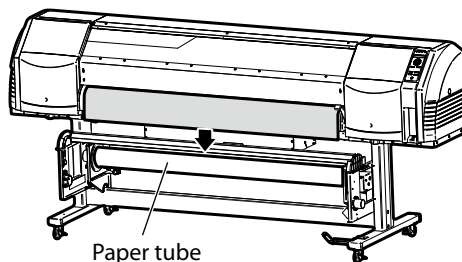

- 7** When the media has reached the paper tube, attach it to the paper tube using tape while keeping it stretched.

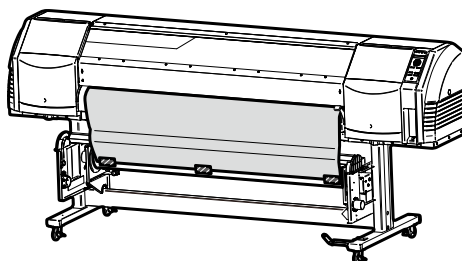

**Note**

- Attach tape to three positions, to the center and to both ends.
- Pay attention when attaching the media as the media may skew if it is not straight to the tube.

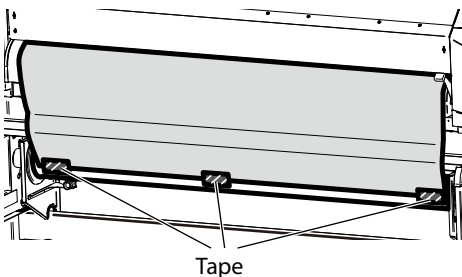

- 8** Feed more media to make a slack.

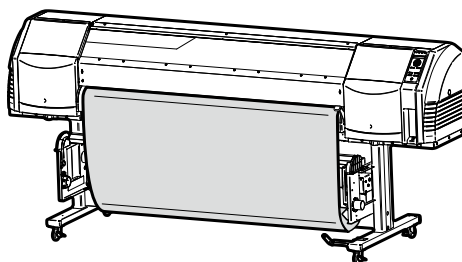

- 9** Return the tension roller from the top position.

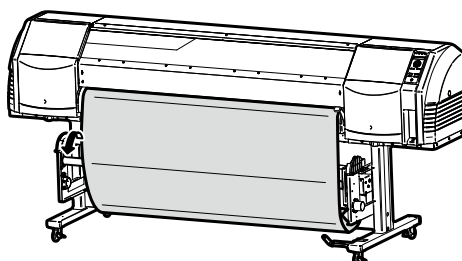

## 10 Set the take-up switch

Inner and outer can be chosen for the take-up direction.

Set the switch to the proper mode based of the figure below.

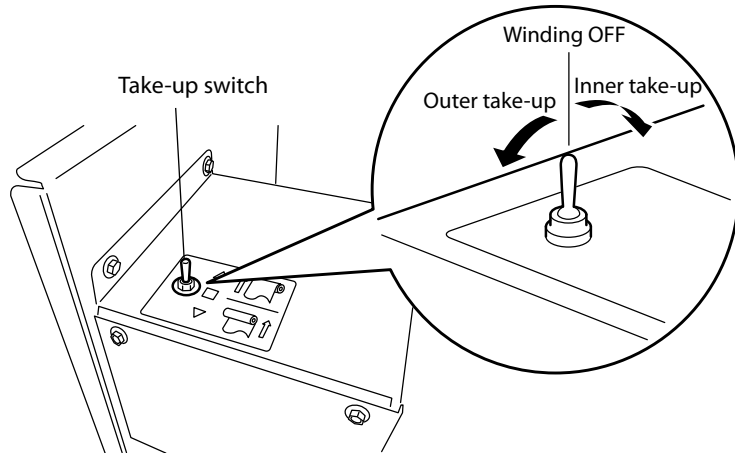

- Use outer take-up with the take-up reel unit type with rear sensor.

### Note

- When using the type without rear sensor, check the position of the media to the take-up sensor, and re-install it if the position is not correct.

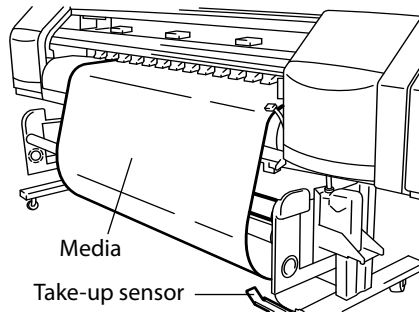

○ The media is above the take-up sensor.

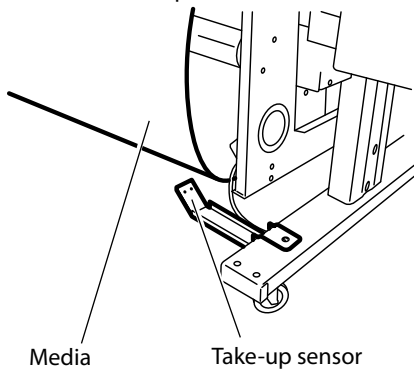

✗ The media goes under the take-up sensor.

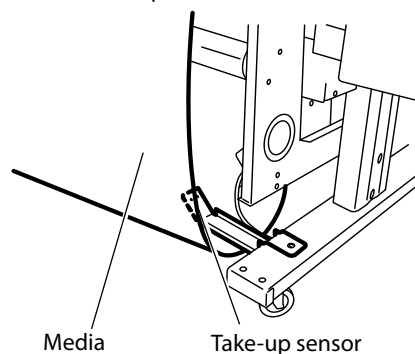

## Tension take-up / Loose take-up setting

With the take-up reel, either tension or the loose configuration can be selected. In normal use (vinyl chloride with adhesive), the loose method is preferred. With tarpaulin and other media that does not slide well, use the tension configuration if take-up shifts occur.

### ※ Loose take-up configuration

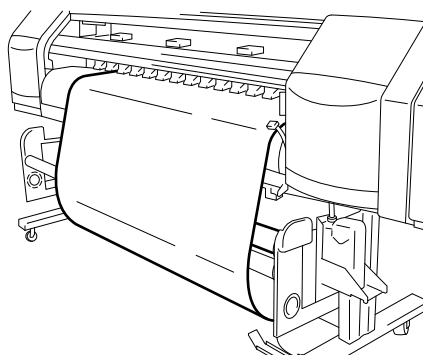

### ※ Tension take-up configuration

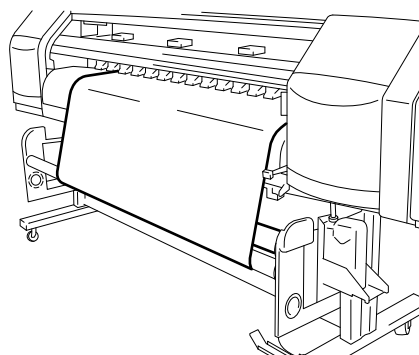

### ■ Tension take-up configuration / Loose take-up configuration setting procedure

In [TUR MODE] of [MEDIA REG MENU], set the tension configuration.

- 1** Press **ONLINE** key to set the printer to offline.

<Operation panel LCD display>

↑INK	MEDIA REG↓
←MEDIA	M.ADV→

- 2** Press **▽** key to enter in MEDIA REG MENU.

#SELECT MEDIA
>XX:YYYYYY

XX: Media number YYYY: Media name

- 3** With **▽**, **△** keys, select [# TUR MODE] and press **OK** key.

#TUR MODE
>XX:LOOSE *

XX: Media number

- 4** With **▽**, **△** keys, select [LOOSE] or [TENSION] and press **OK** key.

#TUR MODE
>XX:TENSION *

XX: Media number

---

## Take-up switch setting

For the take-up direction, the outer take-up (print side out) or inner take-up (print side in) can be selected.

When take-up is not used, set the take-up switch to [OFF].

Set the switch to the proper mode based of the figure below.

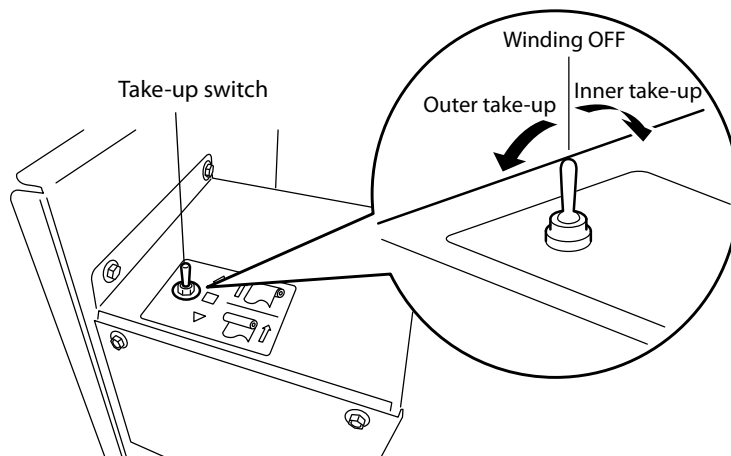

---

### Note

- **With the type without rear sensor, when the take-up roll bottom part gets close to the flange outer diameter, remove the take-up roll and replace it with a new paper tube. If the roll is as shown in the figure below, take-up problems may occur even if the weight remains in the usable range.**

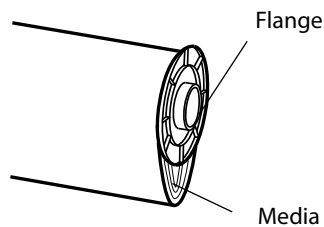

**(When the take-up roll exceeds the flange diameter)**

- **When not using the take-up, the leading edge of the media or the printed surface may touch the take-up sensor. This could affect the quality of the print. Handle the printed surface with care.**



## Using a 2 inch core

With this unit, by removing the 3inch adapter, a 2inch paper tube can be used. To remove the 3 inch adapter, the supplied attachment is needed. The removal procedure of the 3inch adapter is explained below.

- 1 Insert the attachment in the hole in the center of 3 inch adapter.

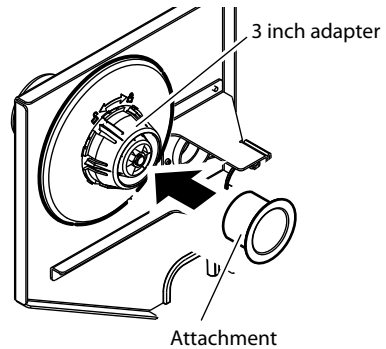

- 2 Turn counterclockwise (↺ in the arrow direction) the 3 inch adapter and pull it out together with the attachment.

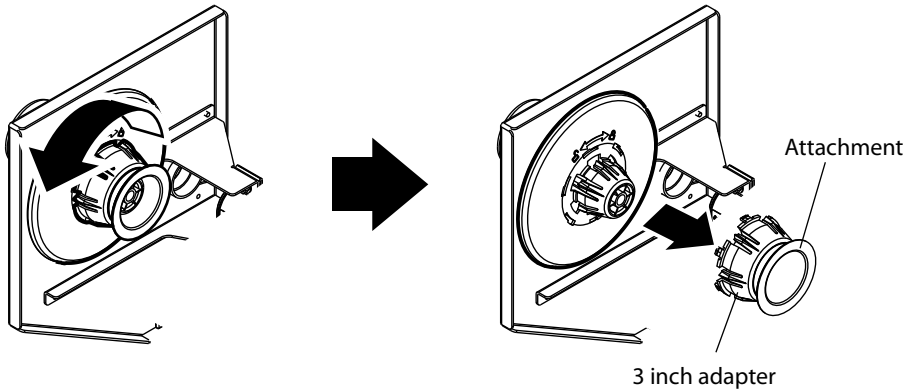

- Install the removed attachment into the left and right plates to keep them for later use. (See the figure at the right hand side.)
- Insert the 3 inch adapter in the slits (holes) of the left and right plates and turn clockwise (↻ in the arrow direction).
- When installing the 3 inch adapter to the flange again, push the hook (projection) of the 3 inch adapter in the slits (holes) of the flange. Turn the adapter clockwise (↻ in the arrow direction). The attachment is not necessary to install the 3 inch adapter.

<In case of installing to the plate (right)>

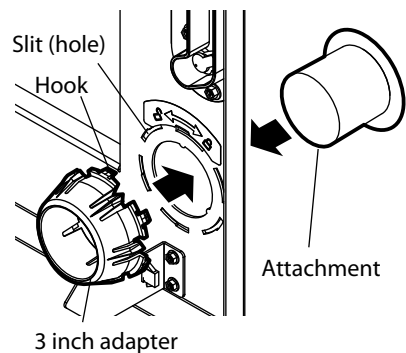

---

**When the media cannot be wound properly in loose take-up using the type without rear sensor**

This section describes how to set the media when the media cannot be wound properly in loose take-up using the type without rear sensor.

[Media replacement] (☞P.2-7) and [How to use the take-up reel unit] (☞P.5-2).

---

**Note**

- **Loose take-up flanges are designed exclusively for the loose take-up. Do not use them for the tension take-up.**
- **Do not grab the outer edge of the loose take-up flanges too strongly. The flanges may turn and injure your hand.**
- **The flanges are not needed when using the type with rear sensor.**



- Loose take-up flanges are necessary:  
When the media cannot be taken up fully by the loose take-up despite the media weighing under 24kg.

In this section, the following parts are used. (The parts are included in the take-up reel unit package.)

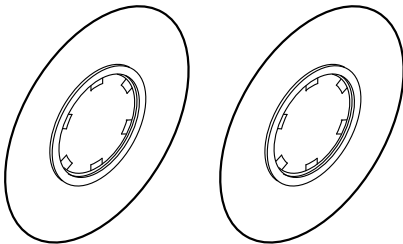

Loose take-up flanges <2 pieces>

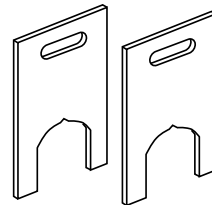

Paper tube spacers <2 pieces>

## Loose take-up flange installation procedure

In this section, the following procedure is for the right side (fixed side). Follow the same procedure to install the flange to the left side(movable side).

### 1 Remove the 3 inch adapter.

Use the supplied attachment to remove the adapter.

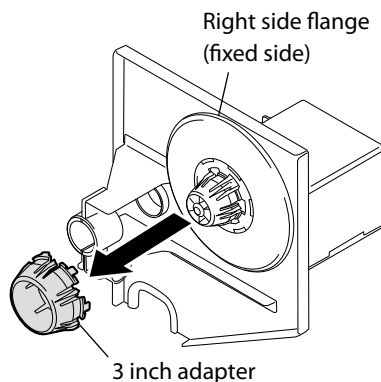

### 2 Install the 3 inch adapter to the loose take-up flange.

Install it to the surface where the sponge is not attached.

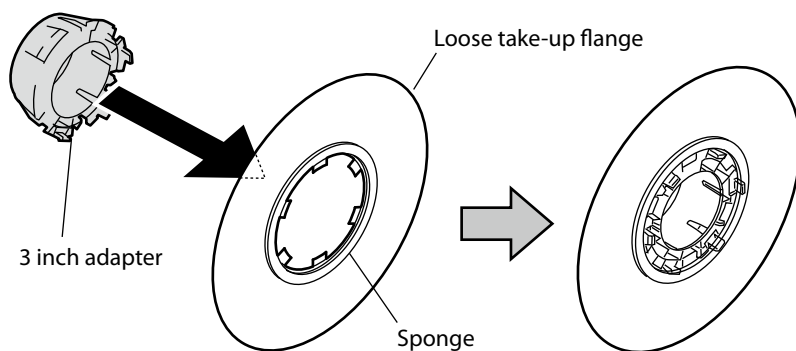

### 3 Install the 3 inch adapter with the loose take-up flange.

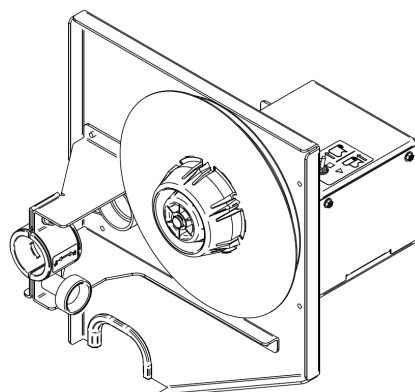

---

## How to use the loose take-up flange

### 1 Adjust the position of the right side flange

---

#### Note

- **The adjustment is required only at the initial operation of the loose take-up configuration.**
- **When the position of the flange holder (at the left of the paper feed side: fixed side) is changed, readjustment is necessary.**

- (1) Advance the media leading edge to the flange position.

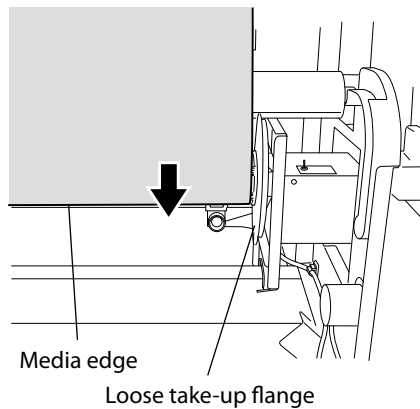

- (2) Shift the fixed side unit so that the gap between the right edge of the media and the loose take-up flange falls within 0 to 2 mm.

---

#### Note

- **To slide the flanges to the right or left, hold the side plate without touching the loose take-up flanges.**

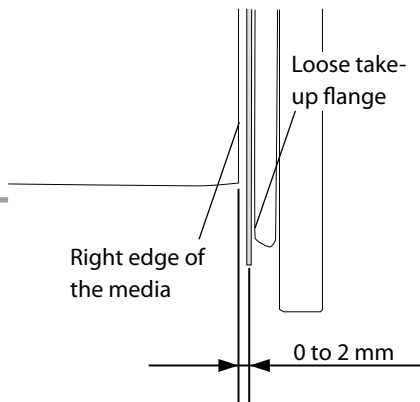

- (3) Tighten the knob at the right side (fixed side) firmly to secure the flange.

## 2 Check the length of the take-up paper tube.

Use a paper tube with the same length as the width of the media set on the printer, or shorter (by 9 mm at maximum.)

### Note

- Do not use a paper tube which is longer than the media width. The media may not be taken up fully due to winding deviation.

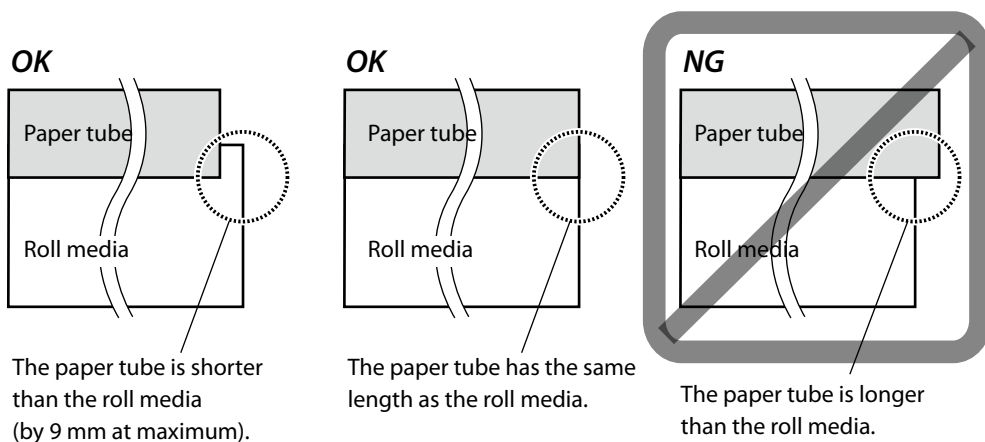

- (1) When the paper tube is shorter than the roll media, apply paper tube spacers and confirm that the difference in length is within 9 mm.  
Install one or two paper tube spacers (4.5 mm thickness for each).

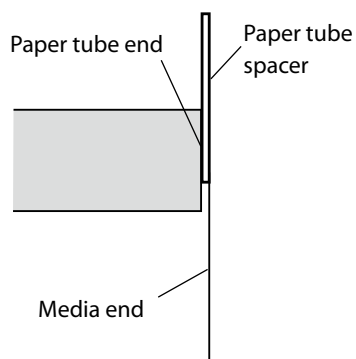

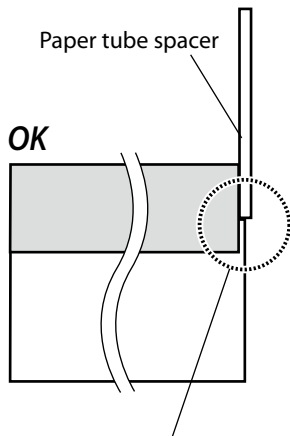

With a single paper tube spacer, the paper tube end exceeds the media end.  
**The difference is within 4.5 mm.**

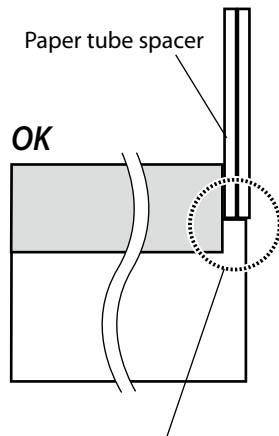

With two paper tube spacers, the paper tube end exceeds the media end.  
**The difference is within 9 mm.**

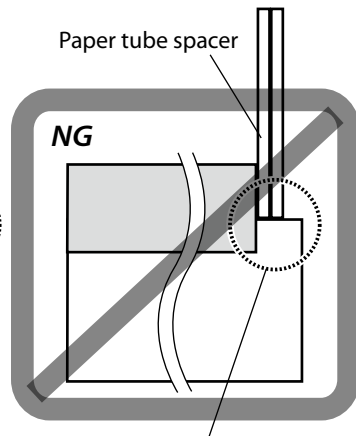

Even with two paper tube spacers, the paper tube end does not exceed the media end.  
**The difference is 9 mm or more.**

---

**Note**

- **2 paper spacers can be used at maximum. Do not use a paper tube which requires more than 2 paper tube spacers.**

**3** Install the take-up paper tube..

Use the paper tube and the paper tube spacer checked in the procedure 2.

- (1) Install the paper tube to the right side flange (fixed side).

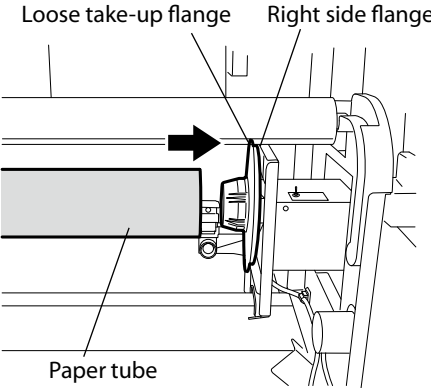

- (2) Install the paper tube spacer checked in the procedure "2.(3)" to the left side flange (movable side).

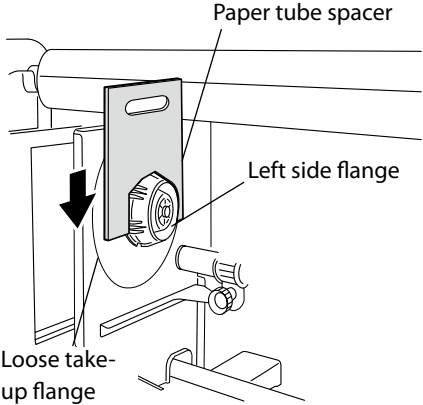

- (3) Slide the left side flange (movable side) so that the paper tube is pressed against the paper tube spacer.

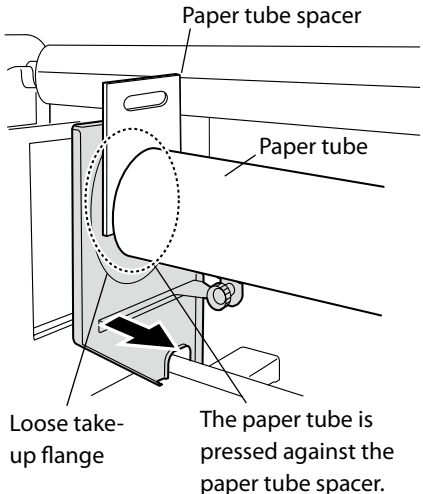

- 
- (4) Tighten the knob at the left side (movable side) firmly to secure the flange.

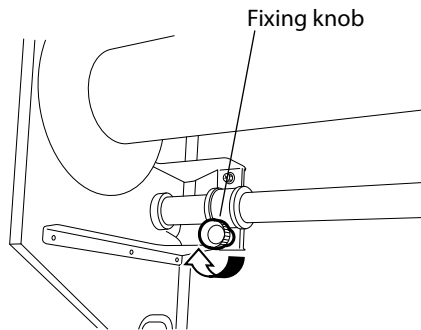

- (5) Pull out the paper tube spacer.  
Remove the flange spacer set in the procedure "2.(1)".

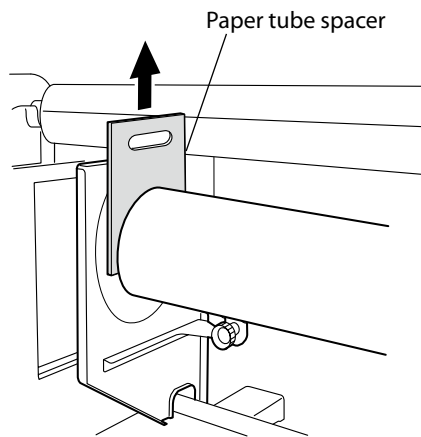



#### 4 Affix the media.

Affix the media to the paper tube at three locations, right, left and center with adhesive tape.

Check whether the gaps between the loose take-up flange surfaces and both media ends are appropriate ( $a+b =$  within 7 mm). The target length of  $a$  is 0 to 2 mm.

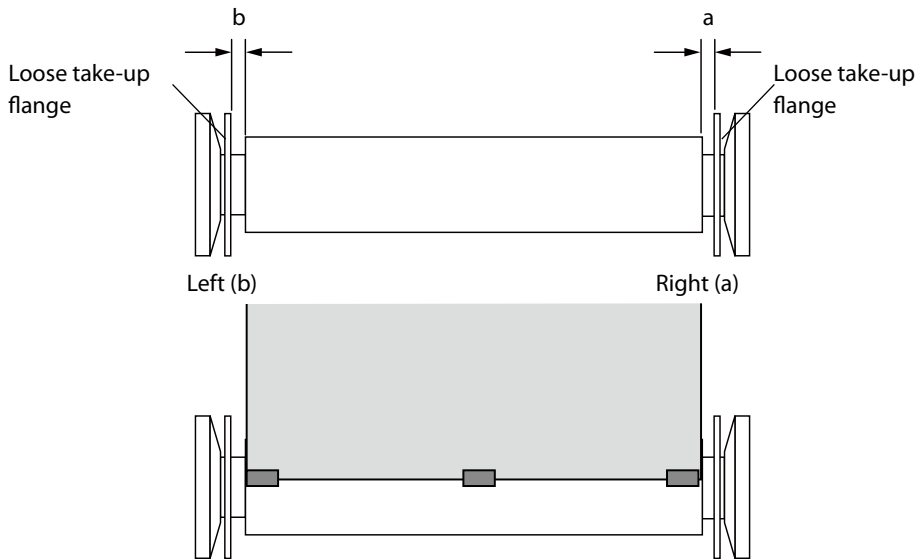

#### Note

- If there is some glue on the loose take-up flange, remove it with adhesive tape or using cap cleaning liquid.

#### Procedure using cap cleaning liquid

- 1 Remove the loose take-up flange from the take-up reel unit.
- 2 After placing the loose take-up flange on an even surface, remove the glue on it with a soft cloth moistened with cap cleaning liquid.

#### Note

- Do not use too much cap cleaning liquid as the loose take-up flange sponge may also be taken off.

- 3 When all the glue has been removed, dry the flange with a soft cloth.

---

## Problems

When printing with loose take-up configuration, under the following conditions the media may become loose and a winding deviation may occur (see figure1). Pay particular attention as if the media deviates, the winding torque may increase resulting in take-up problems.

---

### Note

- If a wound media is left for several hours, the media may become loose and cause take-up problems.
- When performing consecutive prints with loose take-up configuration, assist the take-up operation manually only for the first print.
- When printing with loose take-up configuration on rather elastic media, the media may become loose and cause take-up problems. When using this kind of media, try to not interrupt the take-up operation for a long time. If the take-up operation happens to stop, assist the operation manually as indicated above.
- Winding deviation in the media facilitates the formation of a slack and may cause take-up problems.
- Install the media perpendicularly to the paper tube.
- Install a paper tube matching the width of the media.
- Check that the space between the media and the loose take-up flange is not too large.  
a and b must be so that the media and the loose take-up flange almost contact during printing (see figure 2).

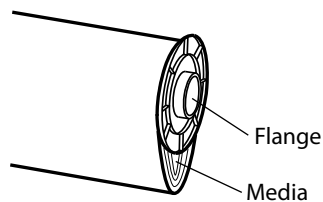

Figure 1 Media winding deviation

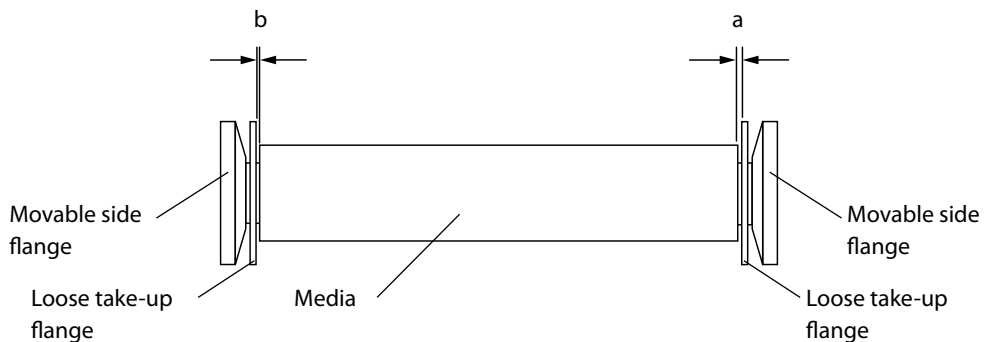

Figure 2

# Adjustment of the take-up reel unit

As the state of roll media during operation always changes depending on the state of roll media finishing (winding shift) and the environment during printing (such as temperature and humidity), wind the roll media while adjusting.

Step 1

**Before printing / take-up.....Initial adjustment**

Step 2

**Problem during take-up.....Adjustment during operation**

## Initial adjustment

### Note

- When executing the initial adjustment, set the take-up switch to OFF.  
(☞ P.5-8 [Take-up switch setting])

**1** Print the adjustment pattern [TUR ADJ PRINT].



**HINT**

- If a blower unit is used, move it to a place where it will not disturb the operation.
- Instead of normal paper that is subject to temperature and humidity influence, a film is recommended.

### How to print the adjustment pattern [TUR ADJ PRINT]

**1** Set the printer to offline. (Press **ONLINE** key.)

<Operation panel LCD display>

↑INK MEDIA REG↓  
←MEDIA M.ADV→

**2** Press **MENU** key twice to display ADJUST MENU.

↑PRINTER SETUP↓  
←ADJUST HEATER→

**3** Press **←** key to enter ADJUST MENU.

#NOZZLE PRINT  
#EXECUTE>

**4** Press **▽** key, select [TUR ADJ PRINT] and press **→** key.

#TUR ADJ PRINT  
#EXECUTE>



**5** Press **OK** key. After warmed up, the adjustment pattern [TUR ADJ PRINT] is printed.

#TUR ADJ PRINT  
#EXECUTE>\*OK ?

#TUR ADJ PRINT  
\*EXECUTING

- 2** Observe the horizontal line of the adjustment pattern and the position of the groove on the tension roller and adjust using the procedure below.

- 2-1** First, adjust the right side. Align the horizontal line of the adjustment pattern with the horizontal line (groove) on the outer circumference of the tension roller.

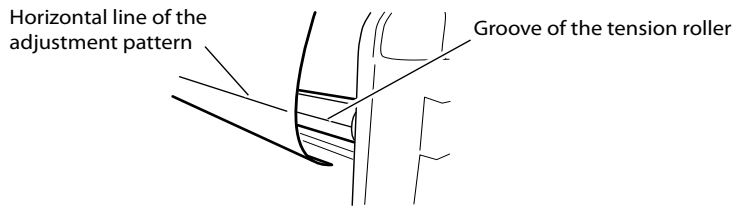

- 2-2** Next, adjust the left side. Confirm that the horizontal line of the adjustment pattern is aligned with the horizontal line (groove) on the outer circumference of the tension roller.

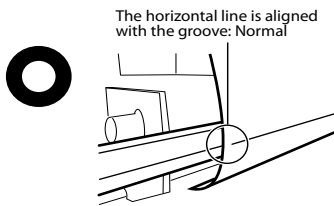
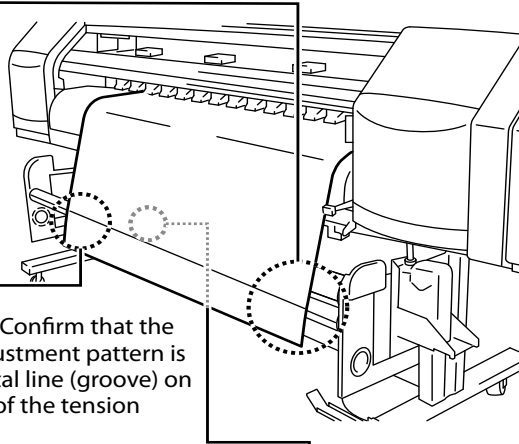

The horizontal line is aligned with the groove: Normal

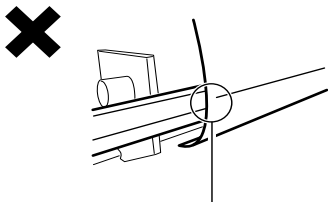

The horizontal line is not aligned with the groove: The adjustment is necessary.

- 2-3** Turn the adjustment screw on the plate (left) to move up or down so that the gap is within the allowable range (about 1 mm).

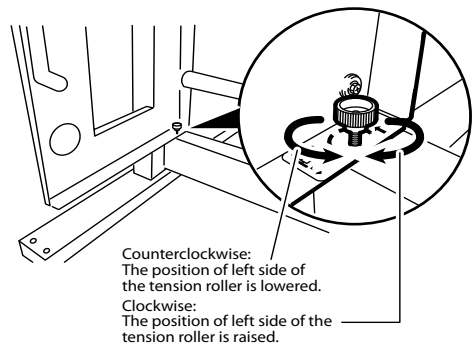

Counterclockwise:  
The position of left side of the tension roller is lowered.

Clockwise:  
The position of left side of the tension roller is raised.

**Adjustment during operation**

If the adjustment is left in the initial adjustment state, depending on this state of media, winding problems such as winding shifts may occur. In this case, solve the problem by turning the adjustment screw on the plate (left).

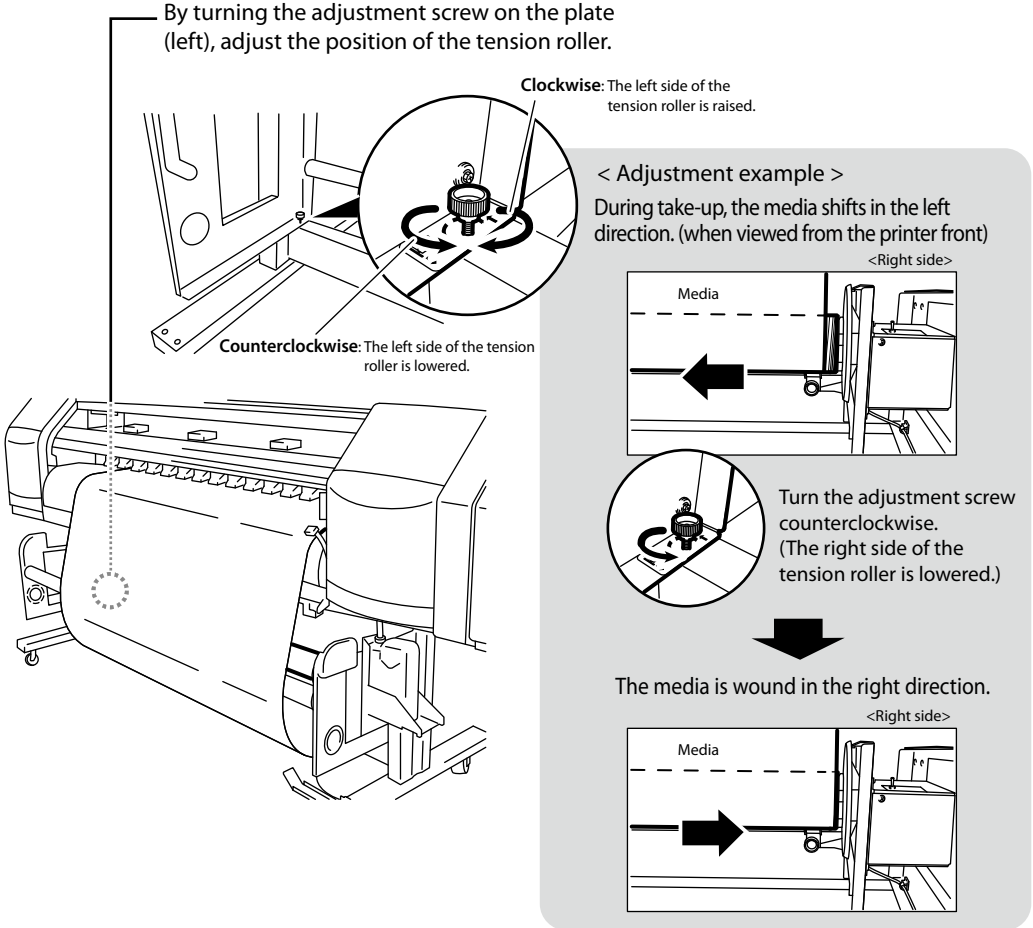

**Note**

- Adjustment may be needed several times during a long print, depending on the condition of the media.

---

When moving the roll media position on the printer, the plate (right) needs to be positioned to meet the media.

---

**Note**

- **Align the end of media with the end of paper tube.**



The end surface of the media is not aligned with the end surface of the paper tube: The adjustment is necessary.



The end surface of the media is aligned with the end surface of the paper tube : Normal

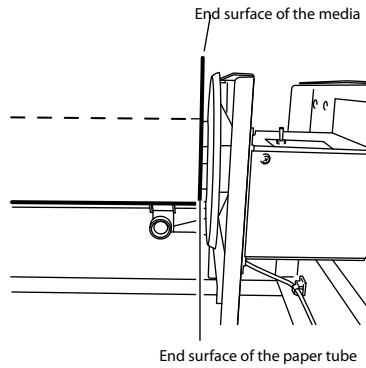
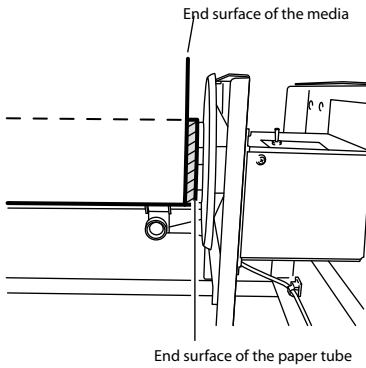

# How to use the blower unit (option)

The blower unit (option) is installed to the paper exit side of the printer and is used to effectively dry the printed media (ink) processed by the printer.

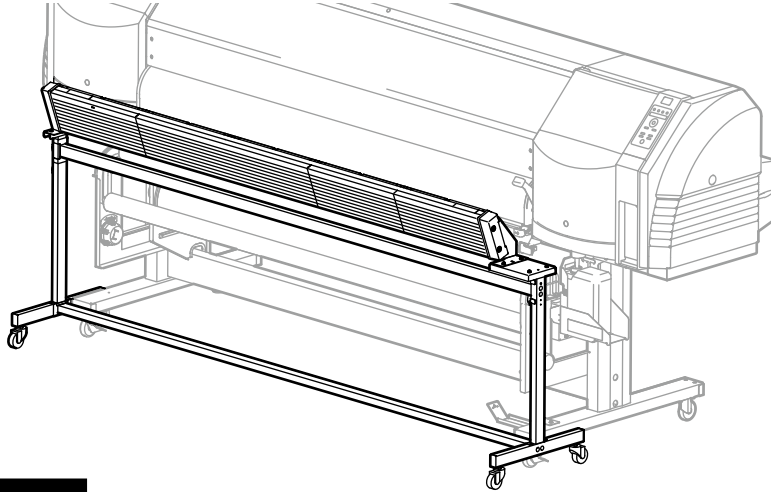

## Normal utilization

- 1 Place the blower unit in front of the printer.
  - (1) Install the blower unit stand to the outside of the printer stand.

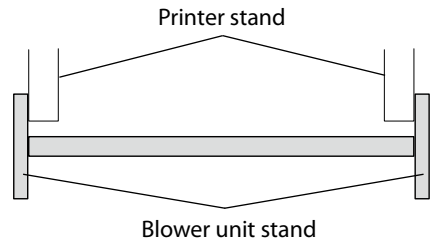

Align the right side for the IP-5520

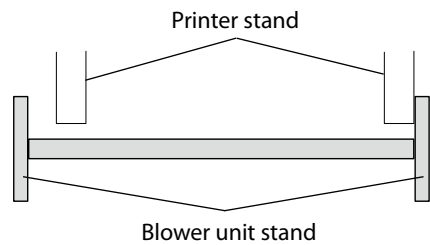

- (2) Push the blower unit until the bar touches the printer stand.

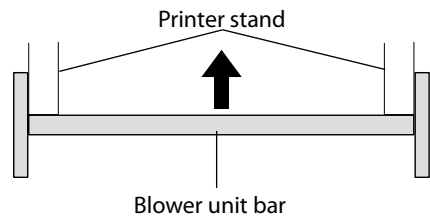

---

## 2 Wind the cable around the hook.

### Note

- It takes time for the ink to dry completely. Processing immediately after printing (laminating, etc.) is not recommended.
- The ink may not dry sufficiently on some media. In this case, set the paper scanning wait time (☞P.3-34) from the operation panel of the printer.

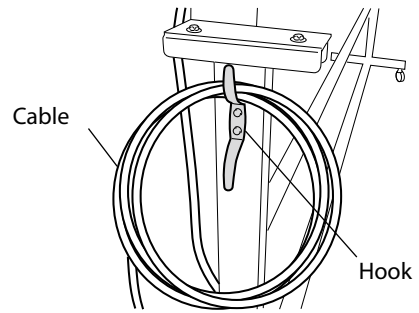

## Handling the media

Move the blower unit to a place where it does not disturb operations before installing the media to the printer (☞P.2-7), installing the media on the take-up reel unit (☞P.5-3) or cutting the media (☞P.5-25).

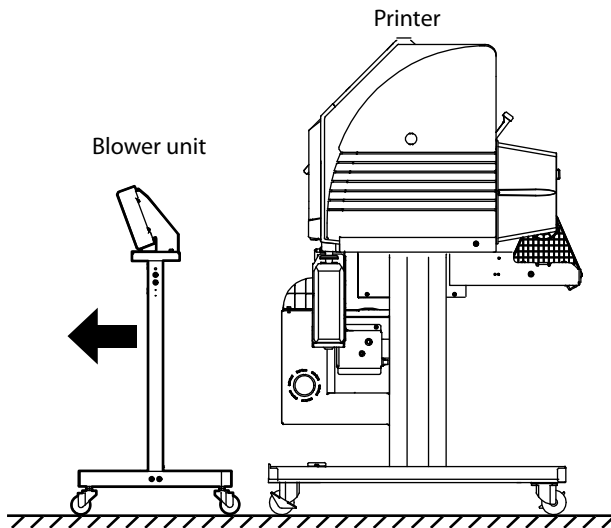



# Cut the media

This section describes the cutting procedure using the optional cutter unit (64) (cutter unit (54) for the IP-5520)



**HINT**

- Move the blower unit (option) in advance to a place where it will not disturb the operation.

- 1** Clip both ends of the media with the media clip.

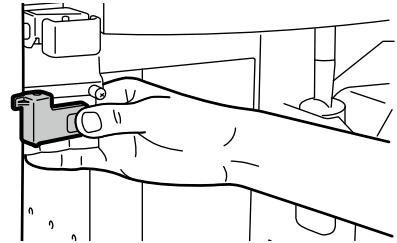

- 2** Move the media cutter blade and cut the media.

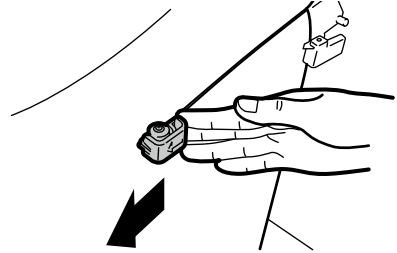

**HINT**

- The arrow mark (g) is engraved on the media cutter blade. The media cutter blade can only cut in the direction of the arrow mark (g). If the arrow mark (g) is not oriented in the cutting direction, change the orientation with the procedure below.

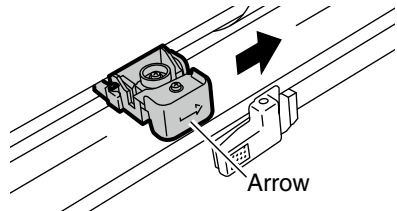

- 1** Hold the side of the media cutter blade and pull it out while releasing the hooks.

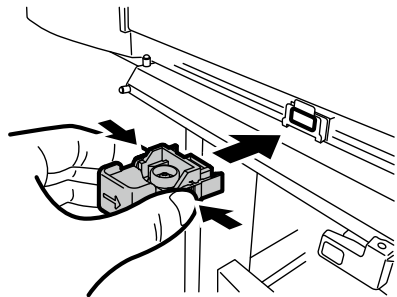

- 2** Invert the media cutter blade so that the left side comes to the right side and then install it.

## Note

- If the media cutter gets stuck while cutting, return the cutter blade to the side, remove curls and other causes of the problem, and cut the media by slowly moving the media cutter blade. Do not forcibly cut a media. Doing so may damage the blade and cutting performance may be degraded.
- If you drop the media cutter blade, the blade may be damaged, resulting in poor cutting performance. Handle it with care.
- The media cutter blade may not be able to cut thicker media. In this case, use a pair of scissors. Forcibly cutting thicker media may damage the media cutter blade and degrade cutting performance.

# Media cutter blade replacement

This section describes the media cutter blade replacement procedure.

- 1** Hold the side of the media cutter blade and pull it out while releasing the hooks.
- 2** Insert a new media cutter blade in the printer.

---

## Note

- If you drop the media cutter blade, the blade may be damaged, resulting in poor cutting performance. Handle it with care.

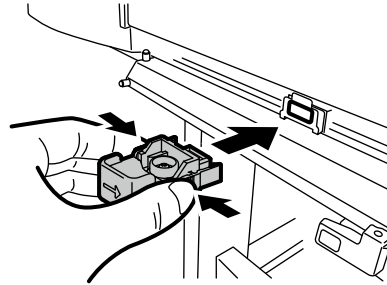

# 6

## *Troubleshooting*

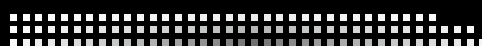

Section 6 describes procedures to follow when encountering problems. If these procedures do not solve the problem, contact your dealer or a service representative.

---

(Content of this section)

When encountering a problem .....	6-2
How to clear media jams .....	6-6
When an error message is displayed .....	6-7
When a warning message is displayed .....	6-13
How to get good image quality.....	6-15
Abnormal sound.....	6-23

# When encountering a problem

When encountering a problem, refer to the following sections for possible solutions.

## ■ Symptoms when encountering a problem

### No power

Symptom/Possible Problem	Resolution
Connection state of power cable	Properly connect the power cable to the outlet.
Power supply to the outlet	Supply the power to the outlet. Confirm that the power voltage is correct.

### The paper guide does not heat after the heater is turned on.

Symptom/Possible Problem	Resolution
Printer status	The paper guide is heated during printing or when the heater is turned on with the heater control menu. Print an image or set the heater to ON to see if the paper guide is heated. <b>(☞ P.2-25 [Changing temperature using the heater control menu])</b>
Computer RIP setting	The heater temperature can also be set by the RIP of the computer. With HEATER PREF set to SOFTWARE on the printer, the heater operation will depend on the print data sent from the computer. Check the computer setting.
Heater control menu	Turn on the heater (after heater/print heater/preheater) again, then print an image or forcibly set the heater to ON to see if the paper guide is heated.

### The printer does not start up or operate.

Symptom/Possible Problem	Resolution
Error LED ON and the message displayed on the LCD	Perform the actions specified by the error message. <b>(☞ P.6-7 [When the error message is displayed])</b>

## Cannot print

Symptom/Possible Problem	Resolution
USB2.0 cable not connected properly	Connect the USB2.0 cable properly. (☞ <b>P.2-2 [Connection to a computer]</b> )
Error LED ON and the message displayed on the LCD	Perform the actions specified by the error message. (☞ <b>P.6-7 [When an error message is displayed]</b> )
Error lamp OFF	Print the test image. (☞ <b>P.3-53 [(1) Nozzle print]</b> )([Test Pattern] of software RIP)
Clean the print head	Run the print head cleaning. (☞ <b>P.4-24 [Print head cleaning]</b> )

## Although the printer is in the print mode, printing does not start and "PH WARMING UP" remains displayed on the operation panel.

Symptom/Possible Problem	Resolution
Room temperature	Raise the room temperature. (Recommended temperature: 20 to 25°C)



### HINT

- Head warming-up is conducted when the room temperature (temperature inside the printer) is low. Recommended room temperature is 20 to 25°C.
- When the low room temperature is raised to 20 to 25°C, it takes time before the temperature of the printer increases. Idle the printer for more than 1 hour before restarting printing.
- Avoid sharp temperature increase to prevent condensation.

## Although the printer is in the print mode, printing does not start and "PREHEATING" remains displayed on the operation panel.

Symptom/Possible Problem	Resolution
Room temperature	Raise the room temperature. (Recommended temperature: 20 to 25°C)
Air flow effect	Do not let air from an air conditioner or fan blowing against the paper guide. Try changing the air flow direction, orientation of the printer or the location of the printer.

---

## Sent data is not printed

Symptom/Possible Problem	Resolution
Online LED (blinking)	Check the communication between the printer and computer.





## Poor image quality

Refer to  P.6-15[How to get good image quality].

## White paper is output

Symptom/Possible Problem	Resolution
Check the print data	Check the print data to make sure that it is not blank.

## Media jams are frequent

Symptom/Possible Problem	Resolution
Type of media	Confirm that the type of media in the setting matches the media loaded. (  P.2-7 [Media replacement])
State of loaded media	Correctly load the media. (  P.2-7 [Media replacement])
An obstacle is caught in the carriage path.	Remove any foreign object in the printer. (  P.6-6 [How to clear media jams])
An obstacle is caught in the media path.	Remove any foreign object in the printer. (  P.6-6 [How to clear media jams])

## Slow printing

Symptom/Possible Problem	Resolution
Low temperature environment	When the temperature in the printer is low (lower than 20°C), heating and warming up times increase and the printing speed is slowed down. Set the environment temperature to the recommended temperature (20 to 25° C), idle the printer for more than 1 hour before restarting printing. In low temperature environments, printing speed may be slowed down to guarantee stable print quality.
High temperature environment	When the temperature in the printer is high (higher than 40 °C), the printing speed is slowed down. Set the environment temperature to the recommended temperature (20 to 25° C), idle the printer for more than 1 hour before restarting printing.
USB transfer speed	Confirm the transfer speed of USB. In case of full speed connection, change the connection environment with the computer to achieve the high speed connection.

## The menu display changes to other language

Symptom/Possible Problem	Resolution
Language setting	While pressing <b>MENU</b> key, power on the printer. The printer starts and the language setting menu is displayed. Set the desired language.

# How to clear media jams

When a media jam occurs, a message is displayed. Clear the media jam following the message instructions and the procedure below.

- 1 A message is displayed.

WARNING! (X)  
CLEAR MEDIA JAM

X: Type of media jam

 P.6-7 [When an error message is displayed]

- 2 Raise the pressure roller up/down lever and open the front cover.

REMOVE MEDIA  
CLOSE COVER

Front cover

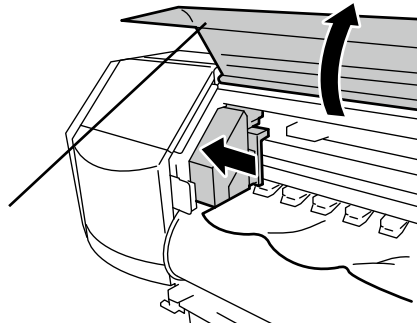

- 3 Remove the jammed media, confirm that no obstacle exists on the carriage path and the media path, then close the front cover.

---

### Note

- With roll media, rewind the media once completely.

CARRIAGE MOVING  
PLEASE WAIT

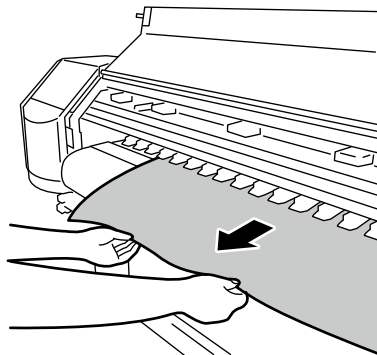

- 4 Refer to [Roll media installation/removal procedure] to set the media.

 P.2-7)

---

### Note

- Due to the media jam, the print head may scrape against the media and cause print defects. In this case, perform the cleaning of print head.

 P.4-24 [Print head cleaning])



# When an error message is displayed

When the error LED lights, first confirm the message displayed on the LCD. The error messages are classified into two shown below.

## Service call error:

This error indicates hardware and software troubles that an operator (customer) cannot resolve. Contact a service representative.

## Operator call error :

This error indicates a problem that an operator (customer) can resolve. Resolve it following the message instructions.

Error messages are explained below.

Perform the appropriate actions following the error message displayed on the LCD.

## Service call error



- When the service call error shown below is displayed, turn off and on the power switch once to start the printer again. The error may be removed.

### Note

- **Wait for more than 1 minute after turning off the printer before turning it on again.**

## (System error)

SYSTEM ERROR nnnn  
RESTART

nnnn :error code



Meaning	An error that cannot be resolved occurred.
Resolution	Contact your dealer or the nearest service representative. Give information about the displayed error code.

---

## Operator call error

Error messages shown below can be resolved by the customer.

### (Ink cartridge)

REPLACE YY INK CARTRIDGE		YY: Y, M, C, K, Lm, Lc, Np, Ny
Meaning	The ink cartridge is empty.	
Resolution	Follow the message instructions.  <b>P.2-30 [Ink cartridge replacement]</b>	
CHECK YY INK CARTRIDGE		Z
		YY: Y, M, C, K, Lm, Lc, Np, Ny Z: Error code (0 - 9)
Meaning	A problem occurs with the ink cartridge.	
Resolution	Follow the message instructions.  <b>P.2-30 [Ink cartridge replacement]</b>	
INSTALL YY INK CARTRIDGE		YY: Y, M, C, K, Lm, Lc, Np, Ny
Meaning	No ink cartridge is installed.	
Resolution	Follow the message instructions. When this message appears with an ink cartridge installed, suspect an improper installation. Check that the ink cartridge is properly installed.  <b>P.2-30 [Ink cartridge replacement]</b>	

## (Waste ink bottle)

BOTTLE OUT  
INSTALL BOTTLE

Meaning	No waste ink bottle is installed.
Resolution	Follow the message instructions. (☞ P.2-40 [Waste ink bottle replacement])

BOTTLE FULL  
REPLACE BOTTLE

Meaning	The waste ink bottle is full.
Resolution	Follow the message instructions. (☞ P.2-40 [Waste ink bottle replacement])

## (Media jam)

WARNING! (1)  
CLEAR MEDIA JAM

Meaning	The media jam (1) occurs when an obstacle exists on the carriage path and the printer cannot drive it normally.
Resolution	Follow the message instructions. If the media jam (1) message continues to appear when there is actually no media jam and no obstacle on the carriage path, contact a service representative. (☞ P.6-6[How to clear media jams])

WARNING! (2)  
CLEAR MEDIA JAM

Meaning	The media jam (2) occurs when the media is not correctly detected. This may be caused by a wrong roll media or cut media selection or when using cut media of a non-specified size length.
Resolution	Follow the message instructions. Check also the content of the settings. (☞ P.6-6[How to clear media jams])

---

## (Media)

NO MEDIA LOADED  
LOAD MEDIA

Meaning The media ran out.

Resolution Set a new media. (☞ P.2-7 [Media replacement])

MEDIA SIZE ERROR  
LOAD MEDIA

Meaning A media of invalid size (less than 297 mm, wider than 64 inches in width) is set.

Resolution Set a media with a correct size. (☞ P.2-7 [Media replacement])

MEDIA MISALIGNED  
RELOAD MEDIA

Meaning The media is skewed.

Resolution Set the media properly. Depending on the importance of the skew, ink may drop on the platen. In this case, wipe off the ink on the platen. (☞ P.2-7 [Media replacement], P.4-20 [Cleaning the platen])

LOAD MEDIA  
LOWER LEVER

Meaning The pressure roller up/down lever is raised.

Resolution Set the media again following the message instructions.

MEDIA MISALIGNED  
OK/CANCEL

Meaning Media skew was detected during printing.

Resolution Continue to print or stop printing.

**(Print head)**

**PH TEMP. ERROR  
PLEASE WAIT**

Meaning	The temperature of the print head is out of the operating temperature range.
Resolution	Use the printer in an environment within the operating temperature. Use the printer only when the temperature reaches the operating temperature.

**PH TEMP. ERROR  
PRINT/CANCEL**

Meaning	The temperature of the print head is out of the operating temperature range.
Resolution	Select whether to continue or cancel the printing.

**XX PH INFO ERROR  
CHECK PRINTHEAD**

Meaning	An error has been detected in the head temperature.
Resolution	Contact your dealer or the nearest service representative.

**XX PH DETECT ERROR  
CHECK PRINTHEAD**

Meaning	A no-head error has been detected.
Resolution	Contact your dealer or the nearest service representative.

---

**(Other)**

**CLOSE COVER**

Meaning The cover is open.

Resolution Follow the message instructions.

**ENV. TEMP. ERROR  
CHANGE ENV TEMP**

Meaning The ambient temperature is out of the printer operating temperature range.

Resolution Use the printer within the printer operating temperature (15°C to 30°C).

**ENV. TEMP. ERROR  
PRINT/CANCEL**

Meaning The ambient temperature is out of the printer operating temperature range.

Resolution Select whether to continue or cancel the printing.

# When a warning message is displayed

After finishing a online print, if any warning information exists, one of the following warning messages is displayed and the ERROR LED  blinks. Perform the appropriate actions based on the error message.

## PERFORM DAILY MAINTENANCE NOW

Meaning	This message is displayed when the regular maintenance (cap cleaning) is not performed.
Resolution	Perform the regular maintenance. (☞ <a href="#">P.4-2 [Periodic maintenance]</a> )

## REPLACE WIPER BLADE

Meaning	This message is displayed when the life of the wiper blade is near to expire.
Resolution	Execute [REPLACE WIPER BLADE] in PH.MAIN MENU to replace the wiper blade. (☞ <a href="#">P.4-26 [Wiper blade replacement]</a> )

## REPLACE WIPER SPONGE

Meaning	This message is displayed when the life of the wiper sponge is near to expire.
Resolution	Execute [REPLACE WIPE SPONGE] in PH.MAIN MENU to replace the wiper sponge. (☞ <a href="#">P.4-30 [[Wiper sponge replacement]</a> )

## REPLACE WIPE CLEANING LIQUID

Meaning	This message is displayed when the wiper cleaning liquid will have to be replaced soon.
Resolution	Execute [REPLACE WIPE LIQUID] in PH.MAIN MENU to replace the wiper cleaning liquid. (☞ <a href="#">P.4-28 [Wiper cleaning liquid replacement]</a> )

---

**PERFORM  
PH RECOVERY NOW**

Meaning	- Periodic cleaning is not performed because PH CLEANING is set to OFF. - Cleaning will be performed automatically before the next printing starts.
Resolution	Perform PH RECOVERY NORMAL  <b>P.4-24 [Print head cleaning]</b>

**CHECK MEDIA  
WRINKLES**

Meaning	The media may have wrinkled.
Resolution	If the media is wrinkled, set the media again or feed it until an area not wrinkled. * Printing on wrinkled media may damage the nozzle surface.

After finishing a online print, if any warning information on the ink cartridges exists, the following warning message is displayed and the ERROR LED  blinks. Perform the appropriate actions based on the error message.

**The ink LED  blinks.**

Meaning	This message indicates that the remaining ink is low.
Resolution	Prepare a new ink cartridge.  <b>P.2-30 [Ink cartridge replacement]</b>



# How to get good image quality

This section provides suggestions for customers to get better image quality with the printer. Resolve the issues based on the symptom.

## Note

- When several solutions are described, they are listed beginning by the most effective ones. It is recommended to perform the solutions from the top and confirm the effect. (It is not necessary to perform all the solutions.)

## Light print

Possible cause	Solution
The operating environment is out of the printer specifications.	Raise the room temperature to higher than 15°C (recommended temperature : 20 to 25°C) so that the printer sufficiently warms up.
The media selection does not matched.	Confirm that the selection of the media in use is correct. (☞P.3-21)

## White lines on the print

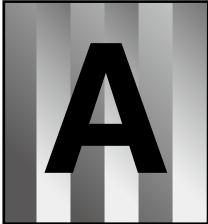

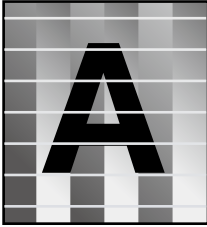

Basic image



[ Cause ]  
The media advance is not properly adjusted.

[ Reference ]  
When the color stripe is printed, white lines appear on all colors.





[ Cause ]  
Print misses of print head

[ Reference ]  
When the color stripe is printed, white lines appear on some colors.







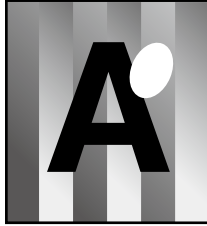





















[ Cause ]  
The media is not well adapted / The ink dries fast.



[ Cause ]  
Print irregularities

Possible cause	Solution
<p>The media advance is not properly adjusted</p> <p> <b>HINT</b> - [Suggestions for media advance value](P.6-22)</p>	<p>(1) Set SMART PASS to MEDIUM or HIGH before printing. (P.3-25)</p> <p>(2) Print the media advance adjustment pattern and adjust the media advance value. (P.4-32)</p> <p>(3) Change the pressure force using the pressure roller up/down lever. (P.2-20)</p> <p>(4) Print the media advance adjustment pattern again and adjust the media advance value. (P.4-32)</p> <p>(5) Print in the unidirectional print mode. (P.3-27)</p> <p>(6) Print with print mode set to HIGH QUALITY or MAX QUALITY. (P.3-24)</p>
<p>Print miss</p>	<p>(1) Check that there is no dust or particles on the platen, and remove them if necessary. (P.4-20)</p> <p>(2) Perform the regular maintenance. (P.4-3)</p> <p>(3) Perform a print head cleaning (NORMAL). (P.4-24) After this, run the nozzle print and confirm that the print miss problem is solved. (P.4-8)</p> <p>(4) Clean the surface of the print heads. (P.4-24) After this, run the nozzle print and confirm that the print miss problem is solved. (P.4-8)</p> <p> <b>HINT</b> - By adding the color stripe when printing, the incidence of print miss is reduced. (P.3-32)</p>
<p>The media is not well adapted / The ink dries fast.</p>	<p>(1) Print the media advance adjustment pattern and adjust the media advance value. (P.4-32)</p> <p> <b>HINT</b> - [Suggestions for media advance value] (P.6-22)</p> <p>(2) Decrease the heater temperature. (P.2-25)</p> <p>(3) Print with print mode set to HIGH QUALITY or MAX QUALITY (P.3-24)</p> <p>(4) Print in the unidirectional print mode. (P.3-27)</p> <p>(5) Print with density set to HIGH DENSITY (P.3-26)</p> <p>(6) Print using a known media with good performance.</p>
<p>Print irregularities</p>	<p>(1) Use a different media. (P.2-7)</p>

## Black lines on the print

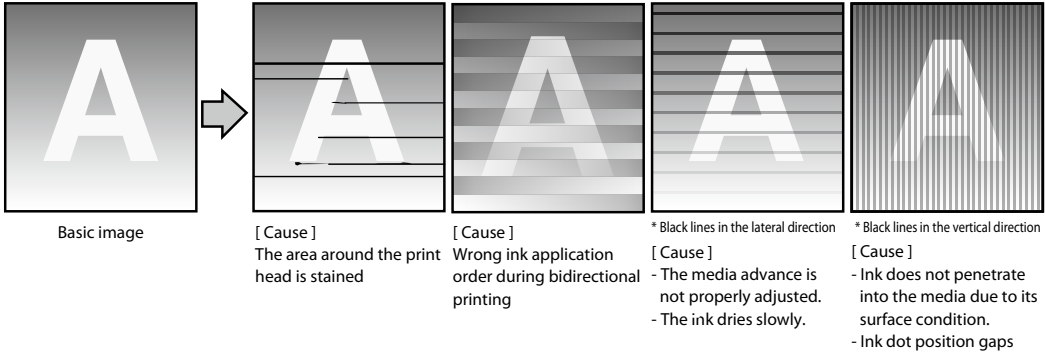

Possible cause	Solution
The area around the print head is stained.	<ol style="list-style-type: none"> <li>(1) Clean the surface of carriage base. (👉P.4-21)</li> <li>(2) Clean the head guards (👉P.4-22)</li> <li>(3) Raise the height of the print head. (👉P.2-28)</li> </ol>
Wrong ink application order during bidirectional printing	<ol style="list-style-type: none"> <li>(1) Set SMART PASS to MEDIUM or HIGH before printing. (👉P.3-25)</li> <li>(2) Print in the unidirectional print mode. (👉P.3-27)</li> <li>(3) Print with print mode set to HIGH QUALITY or MAX QUALITY (👉P.3-24)</li> </ol>
The media advance is not well adjusted.	<ol style="list-style-type: none"> <li>(1) Set SMART PASS to MEDIUM or HIGH before printing (👉P.3-25)</li> <li>(2) Print the media advance adjustment pattern and adjust the media advance value. (👉P.4-32)</li> <li>(3) Change the pressure force using the pressure roller up/down lever. (👉P.2-20)</li> <li>(4) Print the media advance adjustment pattern again and adjust the media advance value (👉P.4-32)</li> <li>(5) Print in the unidirectional print mode. (👉P.3-27)</li> <li>(3) Print with print mode set to HIGH QUALITY or MAX QUALITY (👉P.3-24)</li> </ol>
The ink dries slowly.	<ol style="list-style-type: none"> <li>(1) Raise the heater temperature. (👉P.2-25)</li> <li>(2) Print in the unidirectional print mode. (👉P.3-27)</li> <li>(3) Print with print mode set to HIGH QUALITY or MAX QUALITY (👉P.3-24)</li> </ol>
Black lines in the vertical direction	<ol style="list-style-type: none"> <li>(1) Print with print mode set to HIGH QUALITY or MAX QUALITY (👉P.3-24)</li> </ol>



**HINT**

- [Suggestions for media advance value] (👉P.6-22)

## Stains on the print

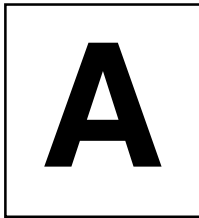

Basic image

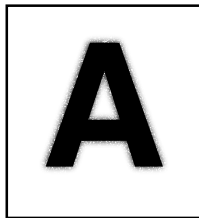

[ Cause ]  
Ink spatters

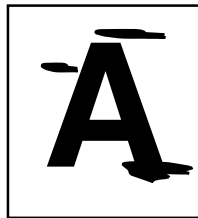

[ Cause ]  
Ink droppings

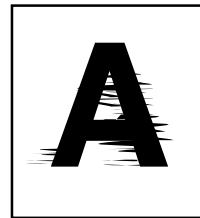

[ Cause ]  
Print head scratched the  
media

Possible cause	Solution
Ink spatters	<ol style="list-style-type: none"> <li>(1) Print with print mode set to HIGH QUALITY or MAX QUALITY (☞P.3-24)</li> <li>(2) Check the height of the print head and put it in the low position if necessary. (☞P.2-28)</li> <li>(3) Perform the regular maintenance. (☞P.4-3)</li> <li>(4) Perform a print head cleaning (NORMAL). (☞P.4-24)</li> <li>(5) Check the environment temperature. (Recommended temperature: 20 to 25°C)</li> <li>(6) Print using a known media with good performance.</li> </ol>
Ink droppings	<ol style="list-style-type: none"> <li>(1) Check that there are no wrinkles or rising on the media or that the media is set straight. Adjust the media position. (☞P.2-7)</li> <li>(2) Check the height of the print head and put it in the high position if necessary. (☞P.2-28)</li> <li>(3) Perform a print head cleaning (NORMAL). (☞P.4-24)</li> <li>(4) Perform the regular maintenance. (☞P.4-3)</li> <li>(5) Clean the print heads surface. (☞P.4-24)</li> </ol>
Print head scratched the media	<ol style="list-style-type: none"> <li>(1) Load the media again. (☞P.2-7)</li> <li>(2) Raise the height of the print head. (☞P.2-28)</li> <li>(3) Adjust the heater temperature to avoid wrinkles. (☞P.2-25)</li> <li>(4) Replace the media. (☞P.2-7)</li> <li>(5) Reduce the environment humidity. (The media may get wet resulting in wrinkle.)</li> <li>(6) Check that the head securing screws are not loosened. (☞P.2-29)</li> </ol>

## Bleeding on the print

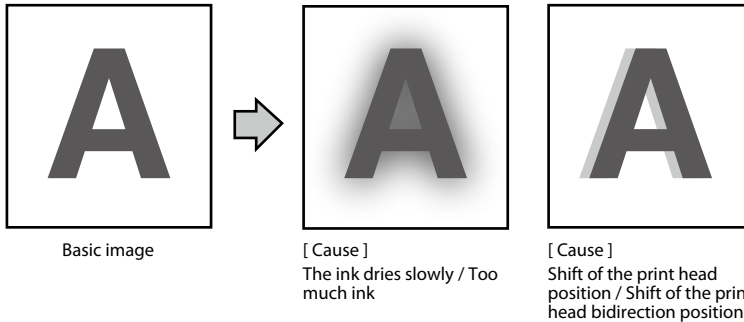

Possible cause	Solution
The ink dries slowly / Too much ink	(1) Raise the heater temperature. (☞P.2-25) (2) Set SMART PASS to MEDIUM or HIGH before printing. (☞P.3-25) (3) Print with print mode set to HIGH QUALITY or MAX QUALITY (☞P.3-24) (4) If the print density was set to HIGH DENSITY, change it to NORMAL (☞P.3-26) (5) If the print was performed in bidirectional mode, change to unidirectional print mode (☞P.3-27)
Shift in the print head position / Shift in the print head bidirectional position	(1) Adjust the print head position. (☞P.4-48) (2) Adjust the bidirection position of the print head. (☞P.4-42)

## Print misses appear when printing starts

Possible cause	Solution
Out of the operating temperature and humidity range	Use the printer within the operating temperature and humidity range. (☞P.1-3)

## Vertical lines on the print edges

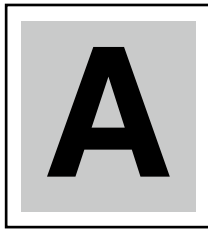

Basic image

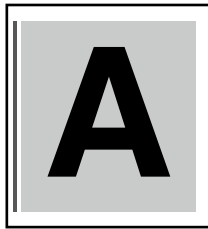

[ Cause ]  
When the left edge of the media under the edge guard is near a vacuum hole on the platen.

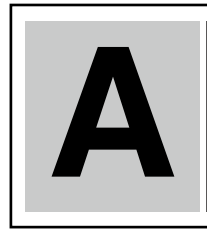

[ Cause ]  
When the right edge of the media under the edge guard is near a vacuum hole on the platen.

### Possible cause

When the edge of the media under the edge guard is near the vacuum hole on the platen, ink may be drawn through the clearance between the media and the edge guard and cause vertical lines.

### Solution

(1) Shift the media so that the contact between the edge of the media and the media edge guard is not near a vacuum hole on the platen. (☞P.2-7)

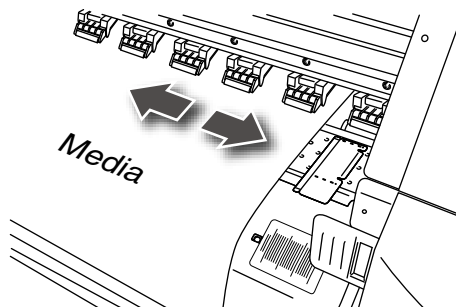

\* Shift the media so that no vacuum hole comes within this range.



Example of media position when vertical lines appear

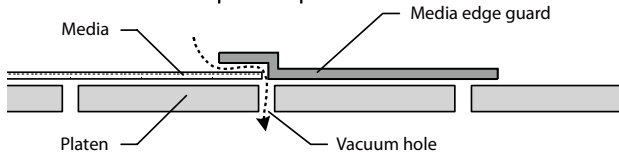

Example (1) of the shift of the media position when the vertical lines appear



Example (2) of the shift of the media position when the vertical lines appear



## Banding differences on the right and left of a print

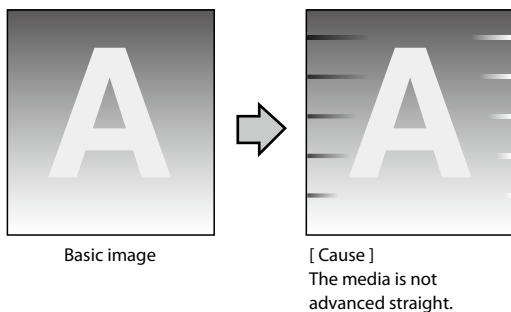

Possible cause	Solution
<p>The media is not advanced straight</p> <div style="display: flex; justify-content: space-around;"> <div data-bbox="212 807 367 952"> <p><b>Skew (winding gap) example</b></p> </div> <div data-bbox="374 807 532 952"> <p><b>Hollow example</b></p> </div> </div> <div style="display: flex; justify-content: space-around; margin-top: 10px;"> <div data-bbox="226 962 367 1116"> <p><b>Bad example</b></p> </div> <div data-bbox="374 962 532 1116"> <p><b>Printer</b></p> </div> </div> <div style="display: flex; justify-content: space-around; margin-top: 10px;"> <div data-bbox="226 1126 367 1280"> <p><b>Good example</b></p> </div> <div data-bbox="374 1126 532 1280"> <p><b>Printer</b></p> </div> </div>	<p>(1) Check that the media on the roll is straight. If is not , replace it .</p> <p>(2) Check that the media is set straight to the printer. If not, adjust the position of the flange holder or shift the media right or left by raising the pressure roller up/down lever to set the media vertically. In addition, when using the take-up reel unit, adjust the position of the flange on the take-up side or re-set the media. (☞P.2-7)</p>

---

## Suggestions for media advance value

The changes mentioned below can affect the media advance value.

Condition		Hint
■ Variation in media condition The appropriate media advance value varies depending on (1) the type and width of media, roll length and (2) change of the roll diameter.	➔	In addition to the factors mentioned to the left, even if the media type is the same, manufacturing differences can affect the appropriate media advance value. Therefore, when replacing a roll, setting the media advance value is required. (👉P.4-32)
■ When changing the take-up mode on the take-up reel unit, the appropriate media advance value varies.	➔	When setting to [loose take-up], the appropriate media advance value is often greater than with [tension take-up]. (👉P.3-29)
■ The appropriate media advance value also varies with the print mode.	➔	The greater the number of passes is, the greater the correct media advance value will be. (👉P.3-32)
■ The appropriate media advance value is different for each color print head.	➔	Normally, it is recommended to set the average value of all colors. However, depending on the print data, you may set the value of the most important color.
■ The correct media advance value differs between the right and left sides of the media.	➔	Normally, it is recommended to set the average of right and left values. However, depending on the print data, you may prioritize the value of the most important position.
■ When media, such as tarpaulin, tends to adhere to the paper guide.	➔	It is recommended that you set the media advance value after printing the media advance pattern, and then make necessary adjustments by changing the adjustment value during real printing. (👉P.4-36)



**HINT** - After setting the media advance value determined from the media advance adjustment pattern, it is possible to improve image quality further by adjusting the media advance value while printing. This is particularly effective for long length printing. (👉P.4-36 [Change during online printing])



## ***Abnormal sound***

---

If you hear an abnormal operating sound compared to the normal ones, contact your dealer or a service representative.



# *Appendix*



This section contains basic specifications, and options and consumables information for the printer.

---

(Content of this section)

Basic specifications.....A-2

Options / Consumables .....A-3

# Basic specifications

## Printer Specifications

### Basic printer specifications

Item	Specification / Function	
Model name	IP-5620	IP-5520
Recording method	Piezo-type color ink-jet printing	
Resolution	540 dpi × 540 dpi (normal mode)	
Paper feed/delivery direction	Rear paper supply, front paper delivery	
Media type	Vinyl chloride (PVC), tarpaulin, coated paper	
Paper width	Maximum of 64 inch	Maximum of 54 inch
Ink cartridge	General solvent ink Six colors (black, cyan, magenta, yellow, light magenta, light cyan) or four colors (black, cyan, magenta, yellow) or six colors (black, cyan, magenta, yellow, neon yellow, neon pink) each in 500 ml ink bottle	
Noise	Standby : 45 dB(A) or less Operating : 65 dB(A) or less (continuous sound)	
Heat output	4860000 J / H or less	
Print guaranteed area	Area excluding top, bottom margins (5 mm) and right and left margins (5 mm) (when using the paper edge guards, right and left margins are 10 mm.)	
Power supply voltage	100-127 V AC / 220-240 V AC	
Frequency	50/60 Hz ± 1Hz	
Power consumption	1350 W or less (during printer operating)	
External dimensions	2830 mm (W) × 830 mm (D) × 1255 mm (H)	2576 mm (W) × 830 mm (D) × 1255 mm (H)
Weight	About 228 kg (With the take-up reel unit (64) installed, without media or ink)	About 205 kg (With the take-up reel unit (54) installed, without media or ink)
Operating temperature/humidity range	15 to 30 °C (60 to 86 °F) / 30 % to 70 % RH (no condensation)	
Non-operating temperature/humidity range	5 to 35 °C (40 to 95 °F) / 10 % to 80 % RH or less (no condensation)	
Installation space	More than 3630 mm(W) × 3830 mm(D) × 1750 mm(H)	More than 3376 mm(W) × 3830 mm(D) × 1750 mm(H)
Maintenance space	More than 3630 mm(W) × 3830 mm(D) × 1750 mm(H)	More than 3376 mm(W) × 3830 mm(D) × 1750 mm(H)

# Options / Consumables

## Options

### Options

Name	Item number	Quantity	Remarks
Exhaust attachment	IP5-265	1	This unit is used to attach an exhaust duct to the printer.
2 inch flange	IP5-261	1	This flange is used to install a roll media with a 2-inch core.
Blower unit	IP-182	1	This unit dries ink by sending air to the media.
Take-up reel unit (64)	IP5-268	1	This unit is used to take-up the printed media (for IP-5620)
Take-up reel unit (54)	IP5-269	1	This unit is used to take-up the printed media (for IP-5520)
Cutter unit (64)	IP5-262	1	This unit is used to cut manually the printed media (for IP-5620)
Cutter unit (54)	IP5-263	1	This unit is used to cut manually the printed media (for IP-5520)

## Consumables

### Consumables

#### (Ink)

Name	Item number	Quantity	Remarks
Ink cartridge / Yellow (GX ink)	IP5-301	1 / carton	500 ml, for the cartridge holder
Ink cartridge / Magenta (GX ink)	IP5-302	1 / carton	500 ml, for the cartridge holder
Ink cartridge / Cyan (GX ink)	IP5-303	1 / carton	500 ml, for the cartridge holder
Ink cartridge / Black (GX ink)	IP5-304	1 / carton	500 ml, for the cartridge holder
Ink cartridge / Light cyan (GX ink)	IP5-305	1 / carton	500 ml, for the cartridge holder
Ink cartridge / Light magenta (GX ink)	IP5-306	1 / carton	500 ml, for the cartridge holder
Ink cartridge / Neon yellow (Neon ink)	IP5-451	1 / carton	500 ml, for the cartridge holder
Ink cartridge / Neon pink (Neon ink)	IP5-452	1 / carton	500 ml, for the cartridge holder
Ink cartridge / Yellow (IX ink)	IP5-311	1 / carton	500 ml, for the cartridge holder
Ink cartridge / Magenta (IX ink)	IP5-312	1 / carton	500 ml, for the cartridge holder
Ink cartridge / Cyan (IX ink)	IP5-313	1 / carton	500 ml, for the cartridge holder
Ink cartridge / Black (IX ink)	IP5-314	1 / carton	500 ml, for the cartridge holder
Ink cartridge / Light cyan (IX ink)	IP5-315	1 / carton	500 ml, for the cartridge holder
Ink cartridge / Light magenta (IX ink)	IP5-316	1 / carton	500 ml, for the cartridge holder
Cartridge holder	IP5-320	1 piece	for IP5-3xx ink cartridge
Waste ink bottle	IP5-299	1 piece	

---

(Maintenance/Cleaning Liquid)

Name	Item number	Quantity	Remarks
Storage liquid cartridge set	IP5-293	1	Storage liquid cartridge : 6
Cleaning liquid cartridge set (for GX ink)	IP5-294	1	Cleaning liquid cartridge : 6
Cleaning liquid cartridge set (for IX ink)	IP5-298	1	Cleaning liquid cartridge : 6
Regular maintenace kit Type S (for GX ink)	IP5-325	1	*1
Regular maintenace kit Type S (for IX ink)	IP5-324	1	*1
Cap cleaning liquid set	IP5-292	1 bottle	300 ml / bottle
Wiper cleaning liquid set (for GX ink)	IP5-291	3 bottles	200 ml / bottle
Wiper cleaning liquid set (for IX ink)	IP5-297	3 bottles	200 ml / bottle
Cleaning stick	IP5-120	1	with a cleaning roller
Cleaning roller set	IP5-147	30 pieces	
Cleaning swab	IP6-147	300	
Cleaning swab (Thick)	IP5-326	30	
Wiper blade (Type S)	IP5-321	2	
Wiper sponge	IP5-123	1	
Media cutter blade	IP5-124	1	for the optional cutter unit (64) and the cutter unit (54)

\*1 Cap cleaning liquid: 300 ml, Wiper cleaning liquid: 200 ml, Cleaning swab: 10, Cleaning roller: 30,  
Wiper blade (Type S): 1, Cleaning stick (with a cleaning roller): 1, tweezers: 1