



















C3400n

Status Lights - Normal

			
			On Line.
			Off Line. (1 blink/2 seconds)
			Initializing/processing/printing/warming up. (1 blink/second)
			Power Save mode. (1 blink/4 seconds)

Handy Reference
Guide de référence pratique
Referencia Rápida
Guia de referência rápida

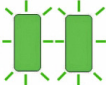
Status Lights - Warnings/Errors

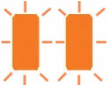
			
			No paper in tray.
			Paper jam. (1 blink/second)
			Warning: Toner Low/Drum near life. <i>Print the Status page by pressing OnLine for 2 seconds, check Recommendations/Warnings.</i>
			Toner lock lever not locked/ toner empty/drum life end/cover open. (1 blink/second)
			Turn the printer off and on again. If this does not clear the error, call for service. (2 blinks/second)

Status Lights and Buttons (cont'd)

Power Paper Alarm

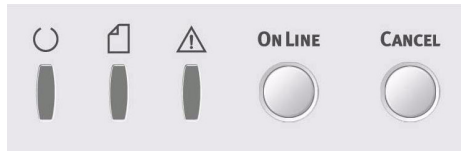

Status Lights

1. Normal status (Green): the printer is operating normally, e.g. it is on line or processing.
2. Warning status (Amber): you can continue to use the printer without intervention but an error may result.
3. Error status (Amber, blinking): you cannot continue to use the printer. Intervention is required to recover from the error.

Detailed Printer Status

See the Status Monitor if you are using Windows, or the Printer Driver in Mac.



Buttons

On Line

Press 1 sec.	<ul style="list-style-type: none">• Shifts to Off Line.• When prompted, begins printing side 2 of a 2-sided document.
Press 2 sec.	Status Page prints.
Press 5 sec.	Demo Page prints.

Cancel

Press 2 sec.	Cancels job 2 seconds after start of switch operation.
-----------------	--

Status Monitor

Double-click the taskbar icon to maximize the status monitor, or click on Start > Programs and select Okidata OKI 3400 Status Monitor. The current printer status is shown.

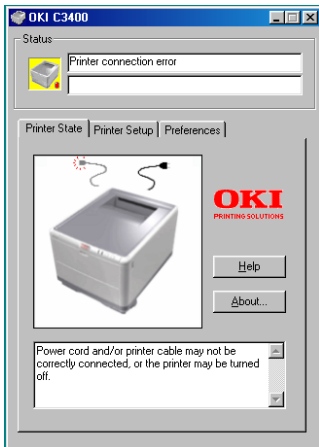

Printer State tab

This tab displays detailed information about the status of the printer.

Printer Setup tab

Selecting this tab provides access to the following:

Select Printer button

When selected, allows you to monitor the status of any printer configured for use with your computer.

Open Configuration button

This button enables you to access the printer menu. From the printer menu, you can configure your printer settings.

Preferences tab

Selecting this tab allows you to choose the information displayed by the Status Monitor and how/when the Status Monitor appears.

Status Monitor (cont'd)

User Settings

On the Status Monitor Setup tab, click the Open Configuration button. The User Settings Print Menu appears. You change user settings options from this menu.



Printer Menu utility (Mac only)

There is no status monitor in Mac. You can change printer user settings through the Printer Menu utility. You can use Windows Print Control Server Software to manage your printer in Mac. For more information, see the User's Guide.

Printing

Print a demo page

Press and hold On Line for 5 seconds.

Print a Status Page

Press and hold OnLine for 2 seconds.

Manual 2-sided Printing (Windows only)

1. Ensure that there is enough paper in the cassette tray to carry out the print job.
2. Select File > Print and click the Properties button.
3. Select either "Long Edge" or "Short Edge".

Note: *If you require further information, click the Duplex Help button.*

4. Click the OK button.
5. Every second page of your document is printed first.

Printing (cont'd)

Using the Cassette Tray

1. Open the cassette tray.

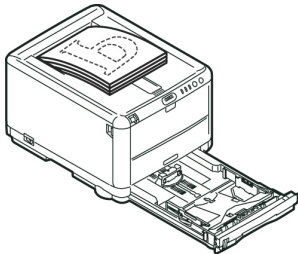

2. Place the printed paper in the tray, printed side facing up.

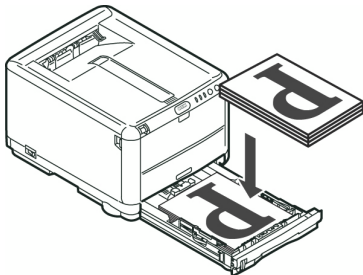

3. Press the On Line button.



Using the Multi-Purpose Tray

1. Take the paper from the output tray.

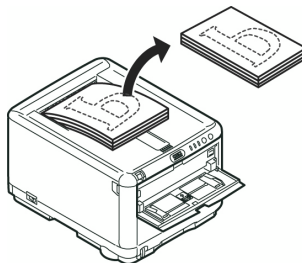

2. Feed one sheet at a time with the printed side facing down and the top of the page facing into the printer.

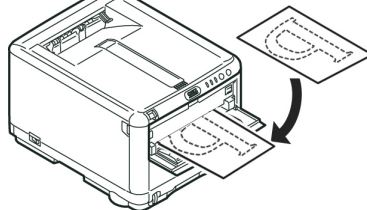

3. Press the On Line button.

Loading Paper

Loading Paper Cassette Tray

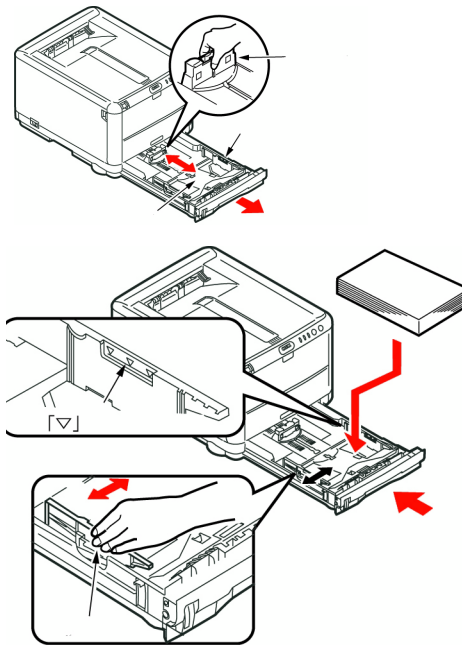

Multi-Purpose Tray

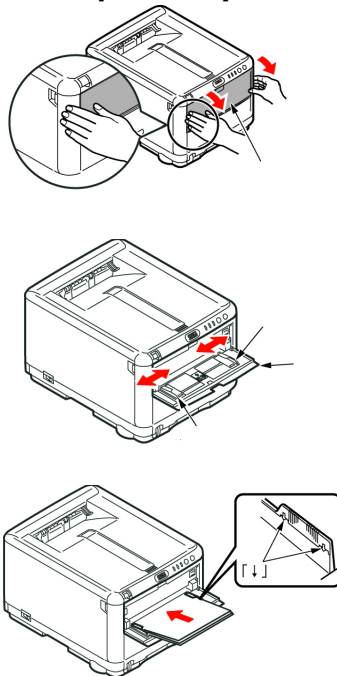

Loading Paper (Cont'd)

Paper Exit

Face Down Stacker

- 150 sheets of 20 lb. [80g/m²]
- Pages print in reading order (last page on top, facing down)

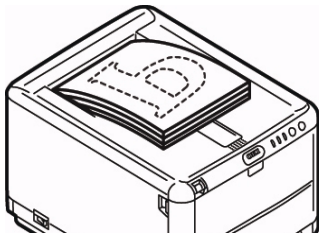

Face Up Stacker

- Open the paper support to exit via this path.
- Holds 10 sheets of 20 lb. [80g/m²]
- Handles stocks up to 54 lb. (203g/m²)
- Always use the Face Up Stacker and the Multi Purpose Tray for paper stocks heavier than 32 lb. (120g/m²)

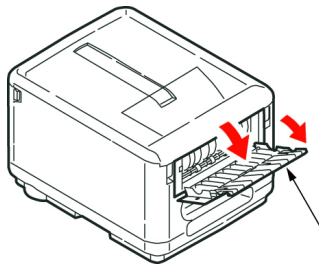

Color Printing

Note: See the online User's Guide for a more complete guide to color printing on your C3400n Printer.

AUTO Settings

For general use, the automatic settings will produce good results for most documents.

Manual Settings

The printer drivers supplied with your printer provide several controls for changing the color output

From a Windows application:

1. Choose File > Print.
2. Click the Properties button.
3. On the Color tab select Advanced Color (1).
4. Choose the Manual color setting (2).

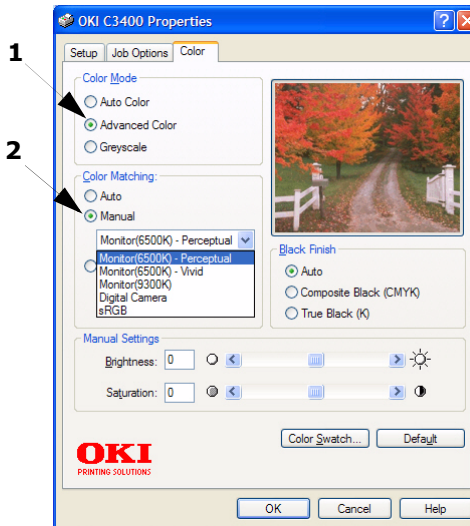

Color Printing (cont'd)

Color Printing from MAC

1. Open the document you want to print.
2. Select File > Print.
3. Select your printer.
4. Select the Color option.

Tips for Printing in Color

Printing Photographic images

Use the Monitor (6500k) Perceptual setting. If the colors look too dull, try the Monitor (6500k) Vivid or Digital Camera settings.

Printing from Microsoft Office Applications

Use the Monitor (9300k) setting. This may help if you are having problems with specific colors from applications such as Microsoft Excel or Microsoft Powerpoint.

Printing Specific Colors (e.g. company Logo)

There are 2 utilities on your printer driver CD-ROM that can help match specific colors:

- Color Swatch Utility
- Color Correct Utility

Adjusting the Brightness or Intensity of a Print

If the print is too light/dark, use the Brightness control to adjust it.

If the colors are too intense/not intense enough, use the Saturation control.

Paper Recommendations

Cassette Tray

Weight	Sizes	Dimensions	
Light: 17-19 lb. (64-74 g/m ²) Medium: 20-27 lb. (75-90 g/m ²) Heavy: 28-32 lb. (91-120 g/m ²)	A6 to Legal 14in.	105 x 148mm to 216 x 356mm	Use paper designed for use in copiers and laser printers. Pre-printed stationery must be designed to use with high fuser temperatures.

Multi-Purpose Tray

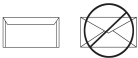
Weight	Sizes	Dimensions	
Medium: 20-27 lb. (75-90 g/m ²) Heavy: 28-32lb. (91-120 g/m ²) Ultra heavy: 33-54 lb. (124-203g/m ²)	A6 to Legal 14in.	100mm x 1200mm (banner printing)	Feed each sheet of paper or envelope one-by-one. For very heavy paper stock, always use the face up (rear) paper stacker. Envelopes should be the rectangular flap type, with glue that can withstand hot roll pressure fusing. Window envelopes are not suitable. Use labels recommended for use in copiers and laser printers in which the base carrier page is entirely covered by labels.
Envelopes			
Labels			

Paper Jams



Clearing from Inside

1.

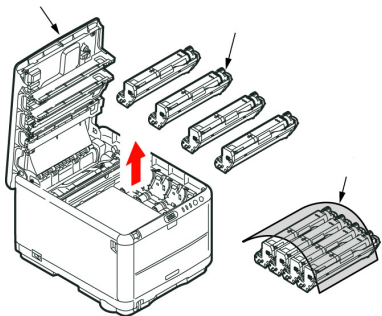

CAUTION! Do not touch the green image drum surface or expose it to light for more than 5 minutes.

2.

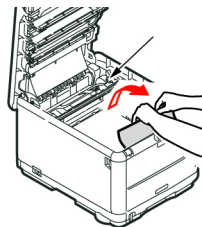
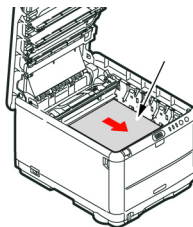

3.

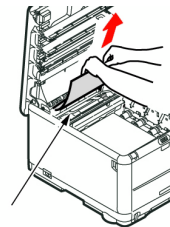
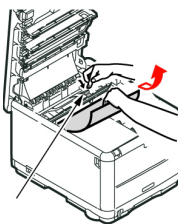

WARNING: The fuser will be hot. Do not touch.

4. If the sheet is well advanced into the fuser, do not attempt to pull it back. Follow the next step to remove it from the rear.

Paper Jams (cont'd)

Clearing at Back

1.

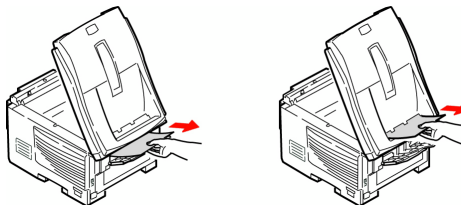

2. If the sheet is difficult to remove, it is probably still gripped by the fuser. Raise the top cover, reach around and press down on the fuser pressure release lever (1).

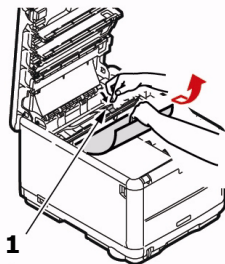

Clearing at Front

1.

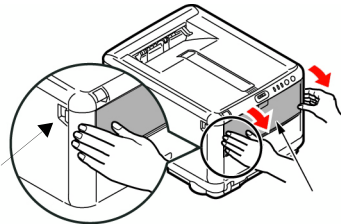

2.

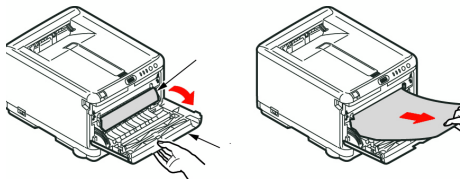

Supplies

Where to Purchase

- Consult the dealer where you purchased your C3400n.
- Consult an Oki Data Authorized Sales or Service Dealer. For the nearest dealer, call 1-800-654-3282.
- *U.S., Puerto Rico, Guam, U.S. Virgin Islands:* Order on the Internet **www.okiprintingsolutions.com**.
- *U.S. only:* Order toll-free at 1-800-654-3282, using VISA[®], MasterCard[®] or AMEX[®].
- Check office supply catalogs.

Take Advantage of OKI's Supply Manager!

- Calculates your usage based on information you provide.
- Sends you an E-mail when it's time to reorder.

To register, go to **www.okiprintingsolutions.com**.

Toner Cartridges

Color	OKI Part #
Black	43459304
Cyan	43459303
Magenta	43459302
Yellow	43459301

Image Drums

Color	OKI Part #
Black	43460204
Cyan	43460203
Magenta	43460202
Yellow	43460201

Other Replacement Parts

Item	OkI Part #
Fuser, 120 V	43377001
Fuser, 220 V	43377002
Transfer Belt	43378001

OKI Print Media

OKI® Synflex™*

- Waterproof, Tear Resistant
- White, 8½" x 11" (216 x 279 mm)

OKI Part #	Qty
52205901	100/box

OKI Bright White Proofing Paper

- White, 32-lb.
- 8½" x 11" (216 x 279 mm)

OKI Part #	Qty
52206101	500/box

OKI Premium Envelopes*

- COM-10 (#10), white wove
- Security tinted, Redi-Strip seal

OKI Part #	Qty
52206301	100/box
52206302	500/box

OKI Banner Paper*

- 70 lb. Index (128 g/m²)
- Size 8½" x 35.4" (216 x 899 mm)

OKI Part #	Qty
52207901	25/box
52206002	100/box

OKI Premium Card Stock*

- Acid-free archival quality
- White, 8½" x 11" (216 x 279 mm)

OKI Part #	Weight	Qty
52205601	60 lb. Cover	250/box
52205602	90 lb. Index	250/box
52205603	110 lb. Index	250/box

* For best printing results:

Temperature range	Humidity
65 to 77°F (18 to 25°C)	40 to 65%RH

Service and Support

First ...

If an alarm (amber light) displays:

1. Make sure paper is loaded in the printer.
2. Turn the printer off and on again.
3. Make sure the toner lock levers are in the locked position.
4. Reinstall the drum/toner units, making sure the toner lock levers are in the locked position.
5. Open the status monitor for an explanation of the alarm.

Consult the store where you purchased your printer.

OKI Resources

- Available 24 hours a day, 7 days a week
- Visit our multilingual web site:

WWW.OKIPRINTINGSOLUTIONS.COM

- Visit **my.okidata.com**.
- Call 1-800-654-3282.

OKI is a registered trademark of Oki Electric Industry Company, Ltd.

3M is a trademark or registered trademark of 3M.

AmEx is a registered trademark of American Express Co.

AMasterCard is a registered trademark of MasterCard International, Inc.

VISA is a registered trademark of Visa.

Windows is either a registered trademark or trademark of Microsoft Corporation in the United States and other countries.

Xerox is a trademark of Xerox Corporation.



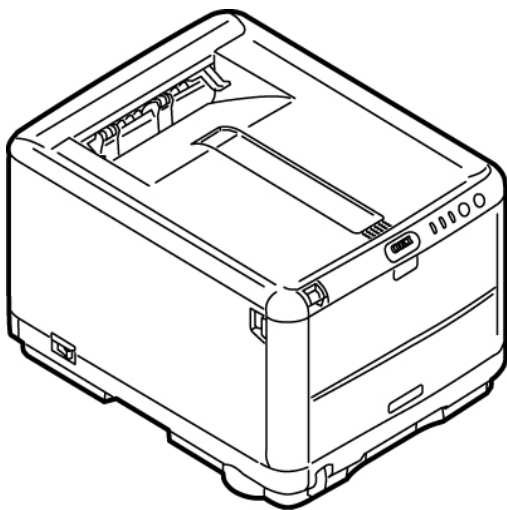



Guide de référence pratique



Français













Illumination et signification

Fonctionnement Normal

			
			On Line (EN LIGNE).
			Off Line (HORS LIGNE). (cycle de 2 s)
			Réception de données, impression, préchauffage. (cycle de 500 ms)
			Mode économie d'énergie. (4,5 s allumé et 500 ms éteint)

Illumination et signification

Un avertissement est indiqué/Erreur

			
			Une alarme de manque de papier.
			bourrage papier. (cycle de 1 secondes)
			Advertisement: Toner Bas/Tambour presque fin. Imprime <i>ou la page d'état</i> ; pression de 2 secondes, (pression 2) pour afficher <i>Recommendations/Warnings</i> .
			Toner non verrouillé/une alarme de consommables usagés/une erreur de capot ouvert. (cycle de 1 secondes)
			Éteignez rallumez puis l'imprimante. Si cela n'efface pas le message, communique avec un centre de réparation. (cycle de 2/1 secondes)

Illumination et signification les boutons

tension papier Alarmes

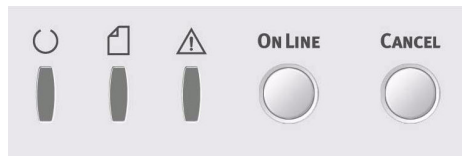

Illumination

1. L'état normal (vert) : l'imprimante fonctionne normalement; elle est par exemple en mode EN LIGNE ou effectue un traitement.
2. État d'avertissement (orange): vous pouvez continuer l'utiliser l'imprimante sans effectuer d'intervention mais une erreur peut se produire.
3. État d'erreur (orange clignotant): vous ne pouvez pas continuer d'utiliser l'imprimante. Une intervention est requise pour reprendre sur l'erreur.

Indique en détail

Le Moniteur d'état indique en détail l'état de l'imprimante dans Windows ou dans le pilote d'imprimante sous Mac.

Interrupteurs

En Ligne

Pression 1 sec.	<ul style="list-style-type: none">• Passe en mode HORS LIGNE.• Lorsque demandé, Pour effectuer une impression recto-verso.
Pression 2 sec.	Imprime une Status.
Pression 5 sec.	Imprime une démonstration.

Cancel

Pression 2 sec.	Annulele travail.
--------------------	-------------------

L'état de l'imprimante

Windows

Double-cliquez sur l'icône (taskbar) pour maximiser l'état de l'imprimante, ou cliquez sur [Démarrer], [Tous les programmes] et sélectionnez Okidata > Oki C3400 > Moniteur d'état. L'état actuel de l'imprimante est affiché.

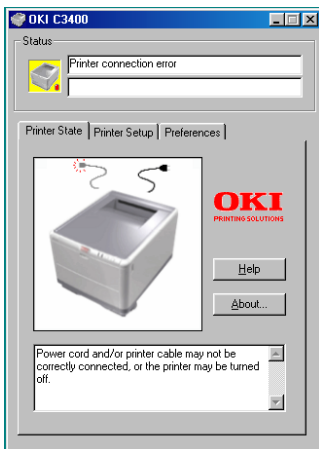

Onglet État de l'imprimante

Affiche des informations détaillées sur l'état de l'imprimante.

Onglet Configuration de l'imprimante

Cliquez sur cet onglet pour accéder au bouton:

Sélectionner l'imprimante

Vous permet de surveiller l'état de toute imprimante configurée pour être utilisée avec votre ordinateur.

Le Bouton Open Configuration

Vous permet d'accéder aux paramètres du menu de l'imprimante. Dans le bouton, vous pouvez configurer vos paramètres d'imprimante.

Onglet Préférences

La sélection de cet onglet vous permet de choisir les informations affichées par le Moniteur d'état ainsi que le moment et la façon dont celui-ci s'affiche.

L'état de l'imprimante (suite)

Paramètres utilisateur

Sous l'onglet Configuration du Moniteur d'état, cliquez sur Open Configuration. Le menu des paramètres utilisateur de l'impression s'affiche. Vous pouvez modifier les options des paramètres utilisateur à partir de ce menu.



Mac

Utilitaire Printer Menu

Il n'existe aucun moniteur d'état sous Mac. Vous pouvez modifier les paramètres utilisateur de l'imprimante à l'aide de l'utilitaire Printer Menu (Menu Imprimante).

Vous pouvez utiliser le logiciel Windows Print Control Server pour gérer votre imprimante sous Mac. Pour plus d'informations, reportez-vous à User's Guide.

Impression

Imprimer une page de démonstration

Appuyez sur le bouton On Line (En Ligne) de votre imprimante, maintenez-le enfoncé pendant 5 secondes.

Imprimer une page d'état

Maintenez le bouton On Line (En Ligne) de l'imprimante enfoncé pendant 2 secondes.

Impression recto-verso (Windows uniquement)

1. Vérifiez qu'il y a suffisamment de papier dans le bac pour effectuer le travail d'impression.
2. Sélectionnez Fichier > Imprimer, puis cliquez sur le bouton Propriétés.
3. Sélectionnez soit "Bord Long" ou "Bord court".

Remarque: *Pour obtenir des informations supplémentaires, cliquez sur le bouton Aide sur l'impression duplex.*

4. Cliquez ensuite sur le bouton OK.
5. Toutes les pages verso de votre document sont imprimées en premier.

Impression (suite)

Utilisant le bac Standard

1. Ouvrez le bac.

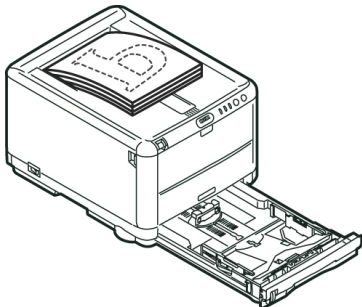

2. Réflexion.

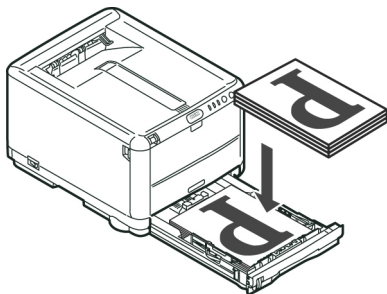

3. Cliquez ensuite sur le bouton On Line.

Utilisant le bac multifonction

1. Prenez les feuilles imprimées dans l'empileuse de sortie.

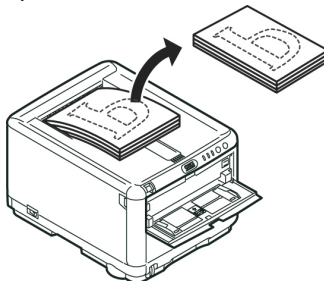

2. Placez les feuilles une par une dans le bac multifonction.

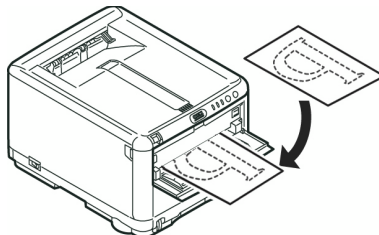

3. Cliquez ensuite sur le bouton On Line.

Chargement du papier

Bac standard

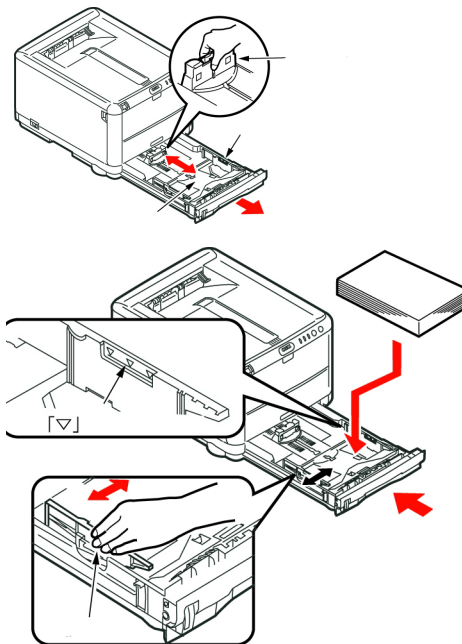

Bac multifonction

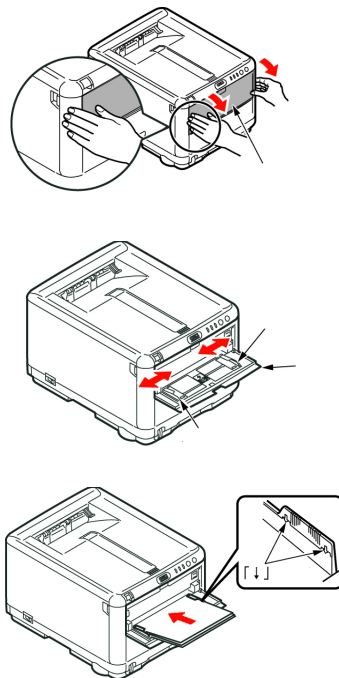

Chargement du papier (suite)

Sorte de papier

Empileuse face vers le bas

- 150 feuilles de 20 lb. [80g/m²].
- Les pages imprimées dans l'ordre de lecture (page 1 d'abord) seront triées dans l'ordre de lecture (dernière page au-dessus, face en dessous).

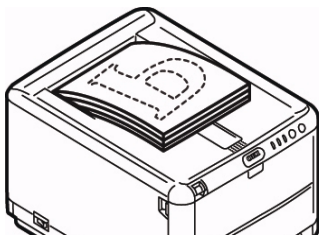

Empileuse face vers le haut

- L'empileuse face vers le haut située à l'arrière de l'imprimante doit être ouverte et le support à papier doit être déployé lorsque l'empileuse doit être en service.
- Peut contenir 10 feuilles de 20 lb. [80g/m²]
- Peut accepter du papier de 54 lb. (203g/m²)
- Utilisez toujours l'empileuse face vers le haut et le bac multifonction pour le papier dont le grammage dépasse 47 lb. (176g/m²)

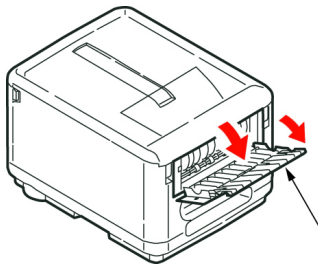

Tirage en couleur

Remarque : Pour plus d'information sur les fonctions, voyez le guide de l'utilisateur en ligne.

Les paramètres automatiques

Les paramètres automatiques par défaut suffiront pour un usage général et donneront de bons résultats pour la plupart des documents.

Les paramètres manuellement

Les pilotes d'imprimante fournis avec votre imprimante offrent plusieurs paramètres permettant de modifier la couleur d'impression sur papier.

Une application Windows :

1. Choisissez Fichier > Imprimer.
2. Cliquez sur le bouton Propriétés [Properties].
3. Sous l'onglet Couleur, sélectionnez Couleur avancée pour la colorimétrie [Advanced Color] (1).
4. Choisissez le paramètre de couleur Manuel (2).
5. Sélection parmi les options.

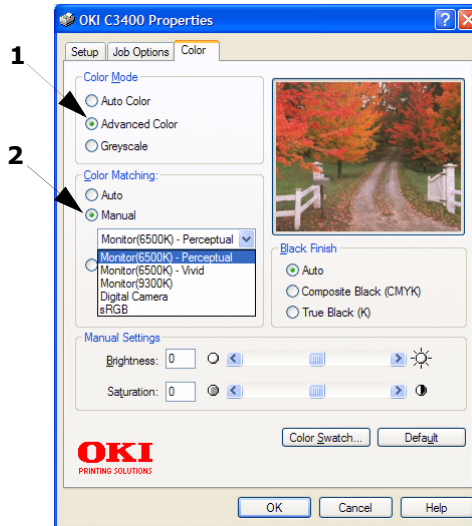

Tirage en couleur MAC

1. Ouvrez le document à imprimer.
2. Sélectionnez Fichier > Imprimer.
3. Sélectionnez votre imprimante.
4. sélectionnez les option color.

Tirage en couleur (suite)

Conseils pour l'impression en couleur

Impression d'images photographiques

Utilisez le paramètre Monitor (6500 k) - Perceptual. Si les couleurs semblent trop ternes, utilisez les paramètres Monitor (6500 k) - Vivid ou Appareil photo numérique.

Impression à partir d'applications Microsoft Office

Utilisez le paramètre Monitor (9300 k). Cela peut vous aider si vous rencontrez des problèmes avec des couleurs spécifiques dans des applications comme Microsoft Excel ou Microsoft PowerPoint.

Impression de couleurs spécifiques (par exemple le logo d'une entreprise)

Deux utilitaires se trouvant sur le CD-ROM de votre pilote d'imprimante peuvent vous aider à faire correspondre des couleurs spécifiques :

- Utilitaire Nuancier de couleurs
- Utilitaire Colour Correct

Réglage de la luminosité ou de l'intensité d'une impression

Si l'impression est trop claire ou trop sombre, vous pouvez utiliser la commande Luminosité pour la régler.

Si les couleurs sont trop intenses ou pas suffisamment, utilisez la commande Saturation.

Recommandations le papier

Bac standard

Grammage	Format	Dimensions	
Light (Léger) : 17-19 lb. (64-74 g/m ²) Medium (Moyen) : 20- 27 lb. (75-90 g/m ²) Heavy (Lourd) :28-32 lb. (91-120 g/m ²)	A6 - Legal (14 pouces)	105 x 148mm - 216 x 356mm	Vous obtiendrez une performance optimale en utilisant du papier standard conçu pour les photocopieurs et les imprimantes laser. Le papier préimprimé peut être utilisé mais l'encre ne doit pas causer de maculages lors de son exposition à la haute température de l'unité de fusion lors de l'impression.

Recommandations le papier (suite)

Bac multifonction

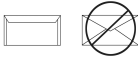
Grammage	Format	Dimensions	
Medium (Léger) : 20-27 lb. (75-90 g/m ²) Heavy (Moyen) : 28-32lb. (91-120 g/m ²) Ultra lourd : 33-54 lb. (124-203g/m ²)	A6 - Legal 14 pouces.	100mm x 1200mm (banner printing)	Lorsque vous utilisez le bac multifonction chargez chaque feuille de papier ou enveloppe une par une, au lieu de les empiler. Pour les papiers très lourds, utilisez toujours l'empileuse de papier (arrière) face vers le haut.
Les Enveloppes			Les enveloppes doivent comporter également des rabats rectangulaires dont la colle reste intacte lorsqu'elle est soumise à la fonction par pression du cylindre chaud qu'utilise ce type d'imprimante. Les enveloppes à fenêtre ne sont pas adaptées.
Les étiquettes			Les étiquettes doivent être également adaptées aux photocopieurs et imprimantes laser, dans lesquelles la feuille de support des étiquettes est entièrement couverte d'étiquettes.

Des bourrages de papier



Regardez dans l'imprimante

1.

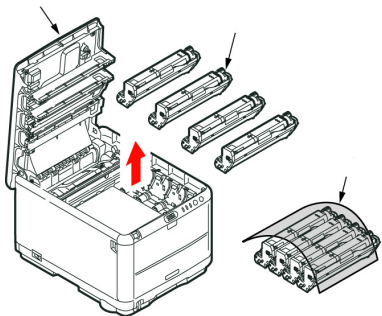

Avertissement! Ne la touchez pas et ne l'exposez pas à l'éclairage normal du local pendant plus de 5 minutes.

2.

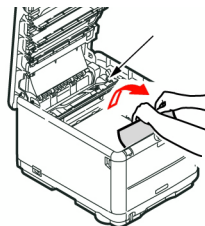
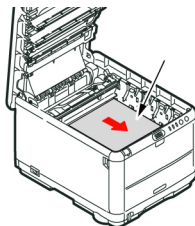

3.

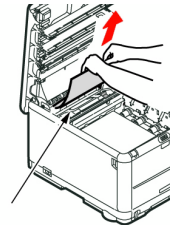
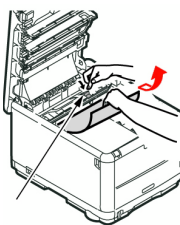

Attention!: L'unité de fusion sera très chaude. Ne pas toucher.

4. Si la feuille est bien avancée dans l'unité de fusion, n'essayez pas de la retirer. Suivez l'étape ci-après pour la retirer depuis l'arrière de l'imprimante.

Des bourrages de papier (suite)

La retirer depuis d'arrière

1.

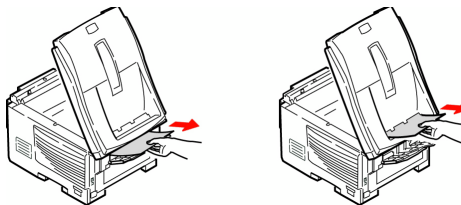

2. Si la feuille se trouve très bas dans cette partie et qu'il est difficile de la retirer, il est probable qu'elle soit toujours prise dans l'unité de fusion. Soulevez le capot supérieur et enfoncez la manette à ressort de rappel de l'unité de fusion (1).

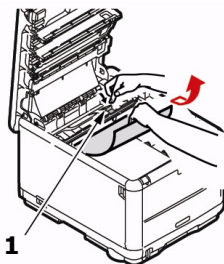

Résolution de accès avant

1.

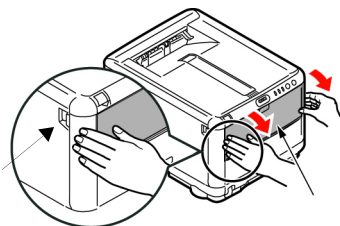

2.

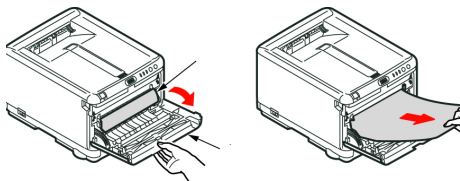

De fournitures

Comment s'y prendre

- Voyez le revendeur qui vous a vendu votre imprimante.
- Voyez un revendeur ou un service après-vent Oki Data agréé. (Pour connaître le revendeur le plus proche, composez le 1-800-654-3282.
- Voyez les catalogues de fournitures de bureau.

Numéros de commande Toners/Tampours

Cartouche de toner

Num.de réf.Oki

Noir.....	43459304
Cyan	43459303
Magenta	43459302
Juane	43459301

Tambour

Num.de réf.Oki

Noir.....	43460204
Cyan	43460203
Magenta	43460202
Juane	43460201

Unités de fusion et courroie de transfert

Item Num.de réf.Oki

Unité de fusion, 120 V	43377001
Unité de fusion, 220 V	43377002
Courroie de transfert	43378001

D'impression OKI

Oki® Synflex™*

- Étanche, Résistant á la déchirure
- Blanc, 8,5 x 11 po (216 x 279 mm)

N° de réf. OKI	Qty
52205901	100 feuilles/boîte

Papier à épreuve blanc brillant Oki

- Blanc, 32-lb.
- 8,5 x 11 po (216 x 279 mm)

N° de réf. OKI	Qty
52206101	500/boite

Enveloppes Oki Premium*

- COM-10 (#10), vélin blanc
- Teinture de sécurité, Redi-Strip

N° de réf. OKI	Qty
52206301	100/boite
52206302	500/boite

Bannière Oki*

- 70 lb. Index (128 g/m²)
- Size 8,5 x 35.4 po (216 x 899 mm)

N° de réf. OKI	Qty
52207901	25/box
52206002	100/box

Carte Oki Premium*

- Qualité archives sans acide
- Blanc, 8,5 x 11 po (216 x 279 mm)

N° de réf. OKI	Weight	Qty
52205601	60 lb.Couverturer	250/boite
52205602	90 lb. Index	250/boite
52205603	110 lb. Index	250/boite

* Pour obtenir les meilleurs résultats :

Plage de température	Humidité
65 to 77°F (18 to 25°C)	40 to 65%RH

Service et Support

D'abord ...

Si un témoin (orange) s'alarme :

1. Assurez-vous qu'il y a du papier dans l'imprimante.
2. Éteignez puis rallumez l'imprimante.
3. Assurez-vous que tous les leviers de blocage des cartouches de toner ont été poussés aussi loin que possible.
4. Réinstallez la d'image/toner.

consultez le revendeur qui vous a vendu votre imprimante.

Ressources Oki supplémentaires

- Offert 24 heures sur 24, 7 jours sur 7
- Visitez notre site Web multilingue :

WWW.OKIPRINTINGSOLUTIONS.COM

- Visitez **my.okidata.com** (Anglais uniquement).
- Composez le 1-800-654-3282.

OKI est une marque déposée Oki Electric Industry Company, Ltd.

3M est une marque déposée ou une marque de commerce de 3M.

AmEx est une marque déposée American Express Co.

MasterCard est une marque déposée de MasterCard International, Inc.

VISA est une marque déposée de Visa.

Windows est une marque de commerce ou une marque déposée de Microsoft Corporation aux États-Unis et dans d'autres pays.





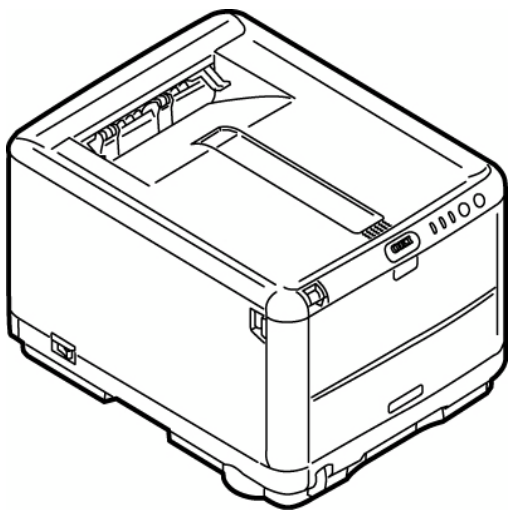

Xerox est une marque de commerce de Xerox Corporation.

Guía de referencia rápida















Español

Luces de estado - Normales

			
			en línea.
			fuera de línea. (parpadeo 1/ciclo de 2 seg.)
			Recepción o impresión de datos, calentamiento, ajuste de densidad o temperatura en curso. (Parpadeo 1/ seg.)
			Modo de ahorro de energía. (Parpadeo 1/ 4 seg.)

Luces de estado - Advertencia/errores

			
			Agotamiento de papel.
			Atasco de papel. (parpadeo 1/seg.)
			Advertencia!: Indica una advertencia o alarma sobre la duración de los consumibles, error de instalación de consumibles. <i>Impresión de una página de estado. Mantenga pulsado el botón ON Line (en línea) durante 2 segundos. Consulte Recommendations/Warnings.</i>
			Cartucho de tóner no bloqueado/es necesario reemplazar algún consumible / error al abrir la cubierta. (parpadeo 1/seg.)
			Apaue la impresora y luego vuelva a encenderla. Si esto no soluciona el problema, pida asistencia técnica. (parpadeo 2/seg.)

Status Lights los Interruptors (cont.)



El estado luces

1. Estado normal (verde): la impresora está funcionando con normalidad, por ejemplo, está ENCENDIDA o procesando.
2. Estado de advertencia (ámbar): puede seguir utilizando la impresora sin intervenir, pero se puede producir un error.
3. Estado de error (ámbar, parpadeando): no puede seguir utilizando la impresora. Es necesario intervenir para recuperarse del error. No es posible la recuperación en caso de errores graves, es necesario llamar al servicio técnico.

El estado detallado

El estado detallado de la impresora se puede conocer en el Monitor de estado en Windows o en el controlador de impresora en Mac.

Botones

En línea

Pulsación breve	<ul style="list-style-type: none">• Cambia a apagad.• Cuando vea mensaje, empieza a imprimir dos caras impresión por las dos caras el documento (sólo en Windows).
Pulsación de 2 segundos	Imprime el página de estado.
Pulsación de 5 segundos	Imprime el página de demostración.

Cancelar

Press 2 sec.	Cancela el trabajo 2 segundos después del inicio de la operación del interruptor.
--------------	---

Monitor de estado (sólo en Windows)

Haga doble clic sobre el icono en la barra de tareas de Windows. O bien haga clic en inicio > Programas > Okidata > Oki C3400n > Monitor de estado. El monitor de estado muestra el estado de la impresora en su monitor.

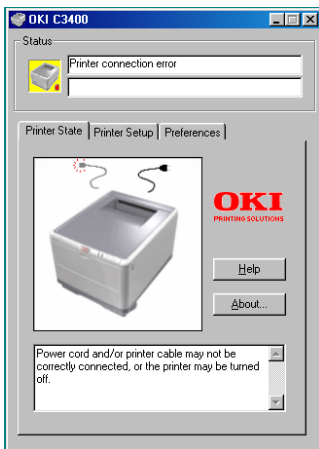

Ficha Estado de la impresor

Esta ficha muestra información detallada sobre el estado de la impresora.

Ficha Configuración de la impresora

Seleccionar esta ficha proporciona acceso al botón:

Seleccionar impresora

Le permite supervisar el estado de cualquier impresora configurado para su uso en el ordenador.

Abierto Configuración

El botón del menú de impresora le permite acceder a los ajustes de la impresora.

Ficha Preferencias

Al seleccionar esta ficha, se puede seleccionar la información que aparece en el Monitor de estado, además de cómo o cuándo aparece dicho monitor.

Monitor de estado (suite)

Ajustes del usuario

En la ficha Configuración del Monitor de estado, haga clic en **Ficha Preferencias**. Aparece el menú de impresión de Ajustes del usuario. Puede cambiar las opciones de ajustes del usuario desde este menú.



Utilidad de menú de impresora (sólo en Mac)

Mac no dispone de monitor de estado. Puede cambiar los ajustes del usuario de impresora a través de la utilidad de menú de impresora.

Puede utilizar el software de servidor de control de impresión de Windows para gestionar las impresoras en Mac. Para obtener más información, consulte el Guide de User.

Impresión

Impresión de una página de demostración

Pulse el botón On Line y manténgalo pulsado durante 5 segundos.

Impresión de una página de estado

Pulse el botón ON LINE (en línea) de la impresora y manténgalo pulsado durante 5 segundos.

Impresión por las dos caras (sólo en Windows)

1. Compruebe que hay papel suficiente en la bandeja de casete para realizar el trabajo de impresión.
2. Seleccione Archivo -> Imprimir y haga clic en el botón Propiedades.
3. seleccione "Borde largo" o "Borde corto".

Nota!: Si necesita más información, haga clic en el botón Ayuda dúplex.

4. Haga clic en el botón OK.

Impresión (cont.)

Utilizando la bandeja de casete

1.

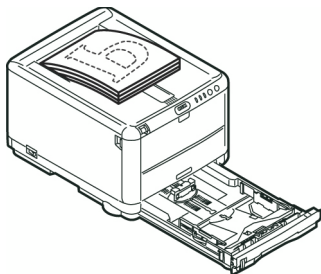

2. Girar la página.

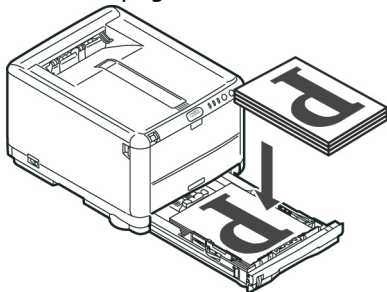

3. Pulse el botón ON LINE.



Utilizando la bandeja multiuso

1.

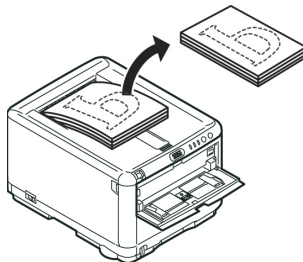

2. Cargue las hojas de una en una.

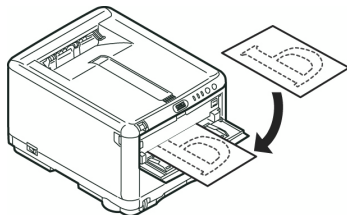

3. Pulse el botón ON LINE.



Carga de Papel

Bandeja de casete

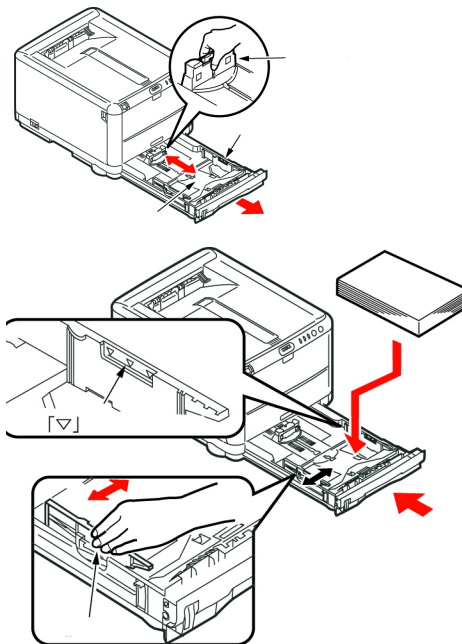

Bandeja multiuso

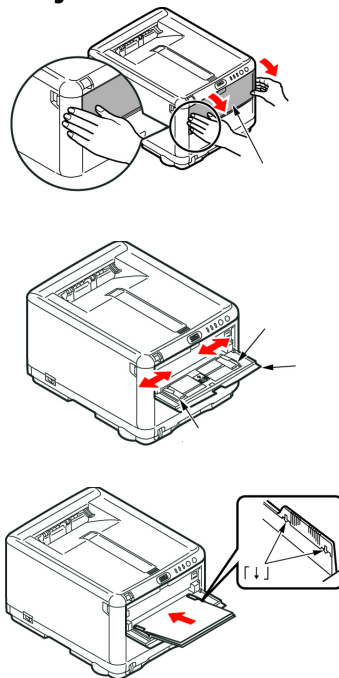

Carga de Papel (cont.)

Paper Exit

Apilador boca abajo

- admite un máximo de 150 hojas de papel estándar de 20 lb. [80g/m²] y puede utilizar papel de hasta 120 g/m² (32 lb)
- Las páginas que se impriman en el orden de lectura (la página 1 primero), saldrán en el mismo orden (la última página en la parte superior, boca abajo).

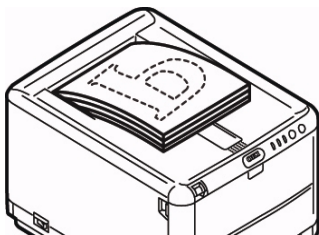

Apilador boca arriba

- Cuando necesite utilizar el apilador boca arriba de la parte posterior de la impresora, ábralo y despliegue el soporte de papel.
- Hasta 10 hojas de papel estándar de 20 lb. [80g/m²]
- Puede utilizar papel de hasta 203 g/m² (54 lb.).
- Use siempre este apilador boca arriba y la bandeja multiuso para tamaños de papel de más de 176 g/m² (47 lb.).

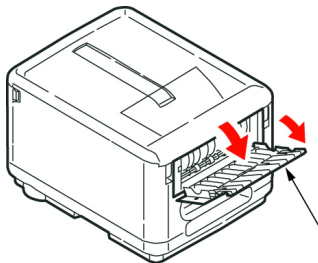

Impresión en color

Nota! Para mayor información, refiérase a la Guía del Usuario.

los ajustes automáticos

Para el uso general, los ajustes automáticos son suficientes, ya que proporcionan ajustes predeterminados razonables que producen buenos resultados con la mayoría de los documentos.

los ajustes Manual

El controlador suministrado con la impresora proporciona varios controles para modificar la salida de color.

From a Windows application:

1. Elija Archivo > Imprimir... en la barra de menú de la aplicación.
2. Haga clic en el botón Propiedades situado junto al nombre de la impresora.
3. En la ficha Color, seleccione Color avanzado en Concordancia de color (1).

4. Elija el ajuste de color **Manual** y seleccione una de las opciones (2).

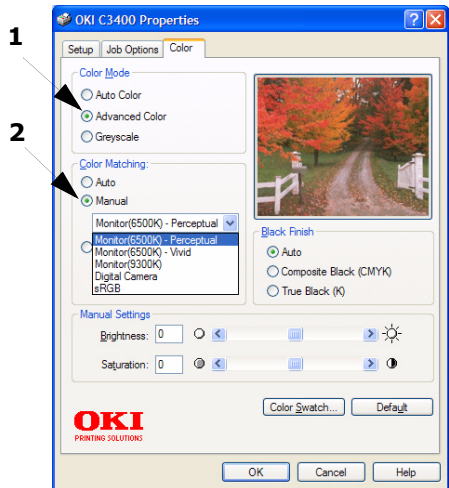

Impresión en color (cont.)

Impresión en color desde MAC

1. Abra el documento que desea imprimir.
2. Seleccione Archivo > Imprimir.
3. Seleccione la impresora.
4. Seleccione las opciones de color.

Consejos para imprimir en color

Impresión de imágenes fotográficas

Utilice el ajuste Monitor (6500k) de alto contraste.

Si los colores tienen un aspecto demasiado apagado, pruebe los ajustes Monitor (6500k) de colores vivos o Cámara digital.

Impresión desde aplicaciones de Microsoft Office

Utilice el ajuste Monitor (9300k). Esto puede ayudarle si está teniendo problemas con colores específicos en

aplicaciones como Microsoft Excel o Microsoft PowerPoint.

Impresión de colores específicos (por ejemplo, el logotipo de una empresa)

Existen 2 utilidades en el CD-ROM del controlador de la impresora que pueden ayudar a concordar colores específicos:

- Utilidad Color Swatch
- Utilidad Color Correct

Ajuste del brillo o la intensidad de una impresión

Si la impresión es demasiado clara u oscura, puede utilizar el control Brillo para ajustarla.

Si los colores son muy intensos, o bien no son lo suficientemente intensos, utilice el control Saturación.

Recomendaciones sobre el papel

Bandeja de Casete

Peso (g/m ²)	Tamaño	Dimensiones	
Ligero: 17-19 lb. (64-74 g/m ²) Medio: 20-27 lb. (75-90 g/m ²) Pesado: 28-32 lb. (91-120 g/m ²)	A6 - Legal 14 pulg.	105 x 148mm - 216 x 356mm	Utiliz un papel diseñado para utilizarce en fotocopiadoras e impresoras láser. Puede utilizar papel preimpreso pero debe asegurarse de que la tinta no se corra al exponerla a las altas temperaturas que se producen en el fusor durante la impresión.

Recomendaciones sobre el papel (cont.)

Bandeja multiuso

Peso (g/m ²)	Tamaño	Dimensiones	
<p>Ligero 17-20 lb. 64-74 g/m²</p> <p>Medio: 20-27 lb. (75-90 g/m²)</p> <p>Pesado: 28-32lb. (91-120 g/m²)</p> <p>Muy pesado: 33-54 lb. (124-203g/m²)</p> <p>Sobre</p> <p>Labels</p>	<p>A6 - Legal 14 pulg.</p>	<p>100mm x 1.200mm (para rótulos)</p> 	<p>Coloque cada hoja de papel o cada sobre uno a uno para su alimentación.</p> <p>Si desea utilizar papel muy pesado, use el apilador de papel siempre boca arriba (posterior).</p> <p>Los sobres deben ser de tipo rectangular plano, con pegamento que permanezca intacto al someterlo a la presión del rodillo caliente del fusor que se emplea en este tipo de impresoras. Los sobres con ventana no son adecuados.</p> <p>Las etiquetas también deben ser del tipo recomendado para utilizar en fotocopiadoras e impresoras láser, en el que la hoja portadora base está totalmente cubierta por las etiquetas.</p>

Atoscos de papel



Interior

1.

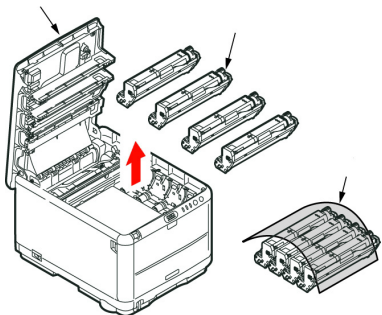

Cuidado! No la toque ni la exponga a la luz normal de la habitación durante más de 5 minutos.

2.

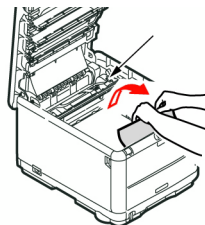
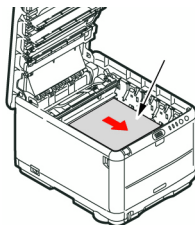

3.

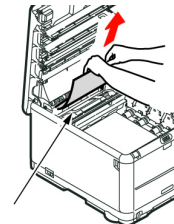
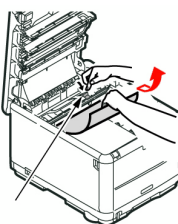

Advertencia!: El fusor estará caliente. No la toque.

4. Si una hoja está casi fuera de la impresora por la parte superior, simplemente tire de ella suavemente para sacarla totalmente. No emplee demasiada fuerza. Podrá quitarla más adelante desde la parte posterior.

Atoscos de papel (cont.)

Posterior

1.

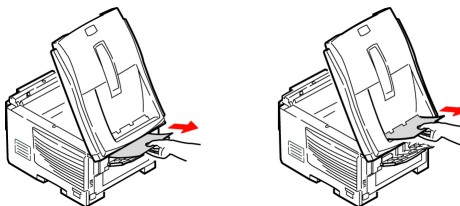

2. Si la hoja se encuentra muy profunda y es difícil de sacar, es probable que aún esté sujeta por el fusor. Levante la cubierta superior, y alcance y presione la palanca de liberación de presión del fusor (1).

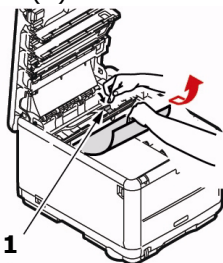

Frontal

1.

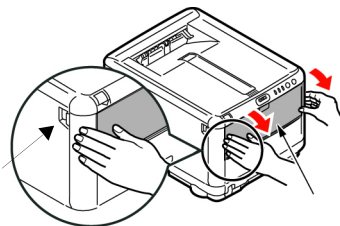

2.

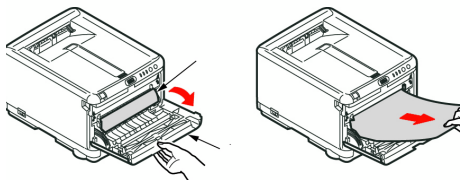

Cómo hacer sus pedidos de suministros

Cómo hacer pedidos

- Consulte el distribuidor donde compró su impresora.
- Consulte un distribuidor autorizado o un proveedor de Servicios de Oki Data. (Para averiguar cual es el distribuidor más cercano, llame al 1-800-654-3282.)
- *Solo en EE.UU., Puerto Rico, Guam, Islas Virgenes (EE.UU.):* Haga sus pedidos en la Internet www.okiprintingsolutions.com.
- *Solo EE.UU.U.S.:* Llamada sin cargo al 1-800-654-3282, y utilice su tarjeta VISA[®], MasterCard[®] o AMEX[®].

Número de los repudstos

Toners

Color	OKI Part #
Negro	43459304
Cian	43459303
Magenta	43459302
Amarillo	43459301

Cilindros

Color	OKI Part #
Negro	43460204
Cian	43460203
Magenta	43460202
Amarillo	43460201

Fusors y cinta de transporte

Item	Oki Part #
Fusor, 120 V	43377001
Fusor, 220 V	43377002
Cinta de transporte	43378001

Instalación

Estos items incluyen las instrucciones de instalación.

Medios de impresión OKI

OKI® Synflex™*

- Impermeable, Indesgarrable
- Blanco, 8½ x 11 pulgadas (216 x 279 mm)

Pedido # Oki	Cantidad
52205901	100/caja

Papel para galeradas blanco brillante Oki

- Blanco, 32-lb. (120 g/m²)
- Tamaño 8½ x 11 pulgadas (216 x 279 mm)

Pedido # Oki	Cantidad
52206101	500/caja

OKI Premium Envelopes (sobres)*

- COM-10 (#10), tejido blanco
- Revestimiento de seguridad, Sello Redi-Strip

Pedido # Oki	Cantidad
52206301	100/caja
52206302	500/caja

Papel para pancartas Oki*

- 70 lb. Índice (128 g/m²)
- Tamaño 8½ x 35.4 pulgadas (216 x 899 mm)

Pedido # Oki	Cantidad
52207901	25/caja
52206002	100/caja

OKI Premium Card Stock*

- Calidad libre de ácidos, para archiva
- Blanco, 8½ x 11 pulgadas (216 x 279 mm)

Pedido # Oki	Peso	Cantidad
52205601	60 lb. Cubierta	250/caja
52205602	90 lb. Índice	250/caja
52205603	110 lb. Índice	250/caja

* For best printing results:

Temperatura	Humedad
65 to 77°F (18 a 25°C)	40 a 65%RH

Servicio y Soporte

Primero ...

Consulte el almacén donde compró su impresora.

Otros Recursos Oki

- Visite nuestro sitio Web multilingüe:
WWW.OKIPRINTINGSOLUTIONS.COM
- Visite **my.okidata.com** (Inglés solamente).
- Estados Unidos: llame al 1-856-222-7496
- México: llame al (525) 263-8780

OKI es una marca de fábrica registrada de Oki Electric Industry Company, Ltd.

3M es una marca de fábrica o una marca de fábrica registrada de 3M.

AmEx es una marca de fábrica registrada de American Express Co.

MasterCards una marca de fábrica registrada de MasterCard International, Inc.

VISA es una marca de fábrica registrada de Visa.

Windows es una marca de fábrica registrada o una marca de fábrica de Microsoft Corporation en los Estados Unidos y en otros países.





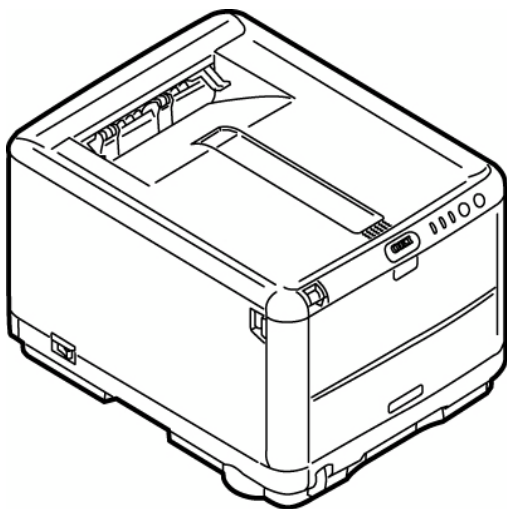

Xerox es una marca de fábrica de Xerox Corporation.

Guía de referência rápida















Português

Iluminação - Normales

			
			LIGADA (On Line)
			DESLIGADO (Off Line) (com uma frequência de 1/2s)
			A receber dados, imprimir, aquecer, regulação de densidade/temperatura em progresso. (com uma frequência de 1/1s)
			Modo de economia de energia. (com uma frequência de 1/4s)

Iluminação - Advertencia/errores

			
			Indica que não há papel ou um pedido de alimentação manual.
			Indica que o papel encravou ou que a tampa está aberta. (com uma frequência de 1/1s.)
			Indica que a duração do consumível está terminando ou um erro de instalação do consumível. <i>Impresión de una página de estado. Imprime uma ou Página de Status. Pressione o botão On Line 2 segundos. Consulte Recomendaciones e Aviso.</i>
			Cartuchos de toner nao locked/es necesario reemplazar algún consumible /error al abrir la cubierta. (com uma frequência de 1/1s.)
			Desligue a impressora e ligue-a novamente. Se isto não resolver o problema, ligue para a assistência técnica. (com uma frequência de 2/1s.)

Iluminação e Botões

Ligada Papel Alarme



Iluminação

1. Status normal (verde): a impressora está funcionando normalmente, ou seja, está ON LINE ou processando algum trabalho de impressão.
2. Status de aviso (amarelo): é possível continuar usando a impressora sem intervenção, mas pode ocorrer um erro.
3. Status de erro (amarelo intermitente): não é possível continuar usando a impressora. É necessário intervir para eliminar o erro. Erros desse tipo são irrecuperáveis e requerem assistência técnica.

Detailed Printer Status

O Status Monitor (Windows) ou o Printer Driver (Mac) fornece informações detalhadas sobre a impressora.

Botões

On Line

Press. 1 sec.	<ul style="list-style-type: none">• Desliga a Off Line.• Quando solicitado, Imprime o verso estiver da documento.
Press. 2 sec.	Imprime página de Status.
Press. 5 sec.	Imprime página de Demo.

Cancel

Press. 2 sec.	<i>Executa o cancelamento da impressão 2 segundos após pressionar o botão.</i>
------------------	--

Monitor de estado

Windows

Para maximizar o monitor de status, clique duas vezes no ícone na barra de tarefas do Windows. (Ou, clique em Iniciar > Programas > Okidata > Oki C3400n > Status Monitor.).

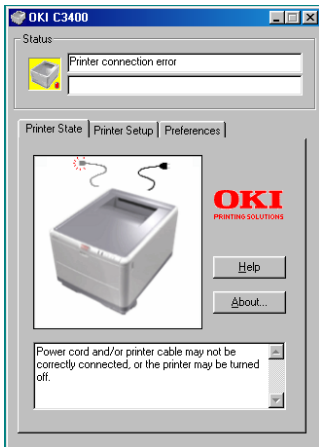

Guia Printer State

Esta guia é exibida quando o Status Monitor é aberto e mostra informações detalhadas sobre o status da impressora.

Guia Printer Setup

Esta guia permite o acesso ao botão:

Selecionar impressora botão

Permite monitorar o status de qualquer impressora configurada para uso pelo computador.

Open Configuration Button

Permite o acesso às configurações do menu da impressora. As configurações da impressora podem ser alteradas a partir do menu da impressora.

Preferences tab

Selecionar esta guia permite escolher as informações que serão exibidas no Status Monitor e como/quando o Status Monitor aparecerá.

Monitor de estado (cont.)

Configurações do usuário

Na guia Status Monitor Setup (Configuração do Status Monitor), clique em Printer Menu (Menu da impressora). O User Settings Print Menu (Menu das configurações do usuário da impressora) aparecerá.



Utilitário Printer Menu (apenas Mac)

O aplicativo Status Monitor não existe no Mac. As configurações do usuário da impressora podem ser alteradas por meio do utilitário Printer Menu. É possível usar o software de servidor de controle de impressão do Windows para controlar a impressora no Mac.

Impressão

Imprima uma página de demonstração

Pressione o botão ON LINE da impressora e mantenha-o pressionado por 5 segundos.

Imprima uma página de status

Mantenha pressionado o botão ON LINE da impressora por 2 segundos.

Impressão Duplex Manual usando a bandeja cassette (Apenas Windows)

1. Certifique-se de que há papel suficiente na bandeja cassette para executar o trabalho de impressão.
2. Selecione Arquivo -> Imprimir e clique no botão Propriedades.
3. selecione Long Edge (Borda Maior) ou Short Edge (Borda Menor).

Nota: Caso você precise de mais informações, clique no botão Ajuda do Duplex.

4. clique no botão OK.

Impressão (cont.)

Impressão Duplex Manual Usando a Bandeja Cassete

1.

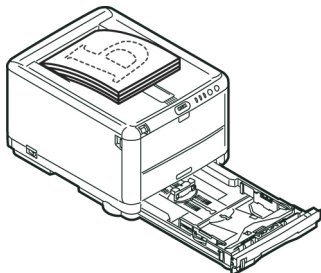

2. Vávir o página.

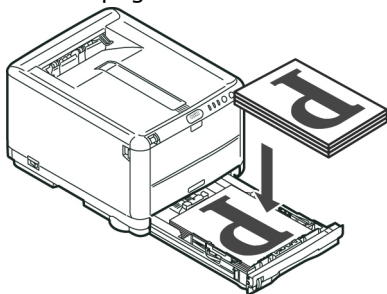

3. clique no botão On Line.

Impressão Duplex Manual Usando a Bandeja Multiuso

1.

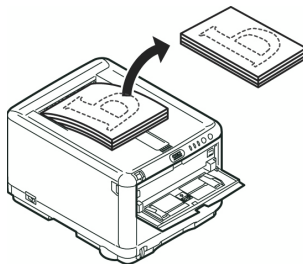

2. Alimente uma folha de cada vez.

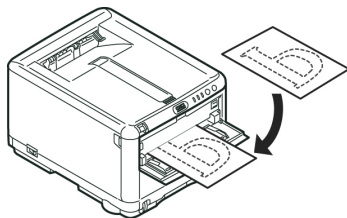

3. clique no botão OnLine.



Colocar Papel

Tabuleiros (bandejas) tipo cassette

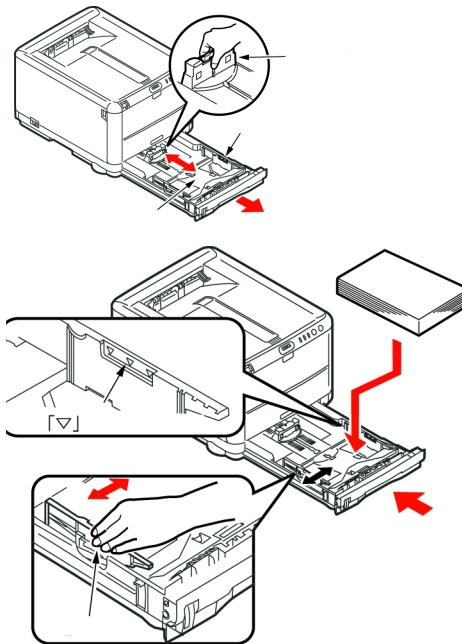

Tabuleiro (Bandeja) multiusos

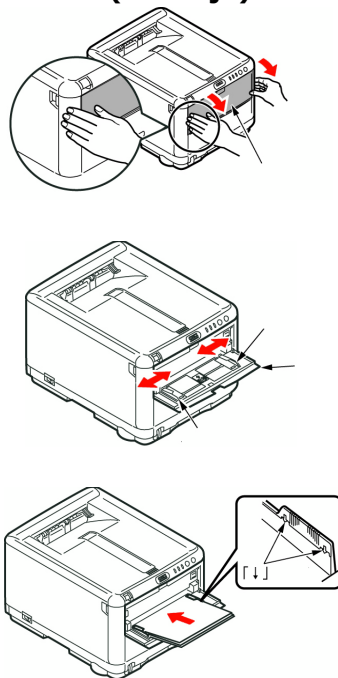

Colocar Papel (Cont.)

Saído do papel

Empilhador de frente para baixo

- máximo de 150 folhas (150 sheets) de 80g/m² (20 lb.)
- As páginas impressas pela ordem de leitura (página 1 primeiro) são ordenadas por ordem de leitura (última página em cima, com a face impressa voltada para baixo).

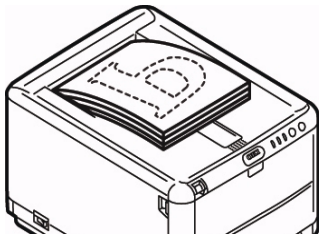

Empilhador de frente para cima

- É necessário abrir o empilhador de frente para cima existente na parte posterior da impressora e puxar a extensão do tabuleiro (bandeja), quando for necessário utilizá-lo.
- O empilhador de frente para cima pode suportar até 10 folhas de papel normal de 80 g/m² e tipos de papel até 203 g/m².
- Sempre use o empilhador de face para cima e a bandeja multifuncional para papéis com gramatura superior a 176 g/m² (47 lb.)

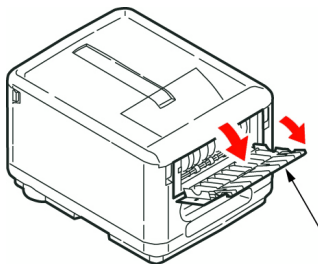

Impressão em cores

Nota: Consulte o manual do usuário online da C3400n para obter mais informações.

definições automáticas

As definições automáticas utilizam configurações normais, uma vez que fornecem predefinições razoáveis que permitem bons resultados para a maior parte dos documentos.

definições de cor manualmente

Os drivers fornecidos com a impressora contêm vários controles para alterar as impressões coloridas. Uma aplicação do Windows:

1. eleccione File>Print... (Arquivo - Imprimir...).
2. Clique no botão Properties (Propriedades).
3. Na guia Cor selecione Cor Avançada para a Correspondência de Cores(1).
4. Escolha a definição de cor Manual e selecione uma das seguintes opções (2).

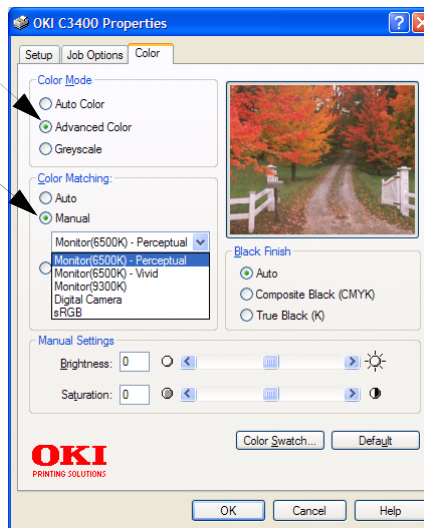

Impressão em cores (cont.)

Impressão a partir de sistema operacional MAC

1. Abra o documento que deseja imprimir.
2. Selecione File [Arquivo] > Print [Imprimir].
3. Selecione a impressora no menu instantâneo Printer (Impressora).
4. selecione as opções cor.

Sugestões para imprimir em cores

Imprimir imagens fotográficas

Utilize a definição do Monitor (6500k) Perceptual.

Se as cores apresentarem pouco brilho, experimente as definições do Monitor (6500k) Vivid ou Digital Cameras.

Imprimir a partir de aplicações do Microsoft Office

Utilize a definição do Monitor (9300k). Isto pode ajudar se tiver

problemas com cores específicas em aplicações como o Microsoft Excel ou Microsoft Powerpoint.

Imprimir cores específicas (por exemplo, o logótipo de uma empresa)

Existem 2 utilitários no CD-ROM do driver da impressora que podem ajudar na correspondência de cores específicas:

Utilitário Color Swatch

Utilitário Color Correct

Ajustar a luminosidade ou intensidade de uma impressão

Se a impressão for demasiado clara/ escura, é possível utilizar o controle de Luminosidade para a ajustar.

Se as cores forem demasiado intensas ou não, utilize o controle de Saturação.

Recomendações relativas ao papel

Tabuleiro (Bandeja) tipo casete

Weight	Sizes	Dimensions	
Leve: 17-19 lb. (64-74 g/m ²) Médio: 20-27 lb. (75-90 g/m ²) Pesado: 28-32 lb. (91-120 g/m ²)	A6 - ofício 14 polegado.	105 x 148mm to 216 x 356mm	Utilizar fabricado para fotocopiadoras e impressoras a laser. Você pode utilizar papel de carta pré-impresso, mas a tinta tem de ser resistente às elevadas temperaturas de fusão utilizadas no processo de impressão.

Recomendações relativas ao papel (cont.)

Tabuleiro (Bandeja) multiusos

Weight	Sizes	Dimensions	
Médio: 20-27 lb. (75-90 g/m ²) Pesado: 28-32lb. (91-120 g/m ²) Ultra Pesado: 33-54 lb. (124-203g/m ²) Envelopes Etiquetas (Labels)	A6 - ofício 14 polegado	100mm x 1200mm (impressão de faixas) 	As folhas de papel só podem ser alimentadas uma de cada vez.. Sempre use o empilhador de face para cima e a bandeja multifuncional para papéis com gramatura superior a 176 g/m ² (47 lb.). Não coloque mais do que 1 envelope de cada vez. Também devem ter aba retangular, com um tipo de cola que não derreta quando sujeita a uma fusão a alta temperatura por rolo, utilizada neste tipo de impressora. Os envelopes de janela não são adequados. As etiquetas também devem ser do tipo recomendado para fotocopiadoras e impressoras a laser, com a página de base totalmente coberta com etiquetas.

Resolver encravamentos de papel



Perspectiva da impressora

1.

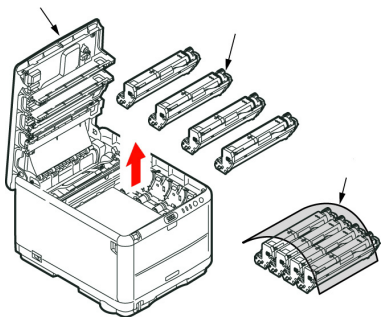

CUIDADO! A superfície verde do cilindro de formação de imagem na base do cartucho é muito delicada e sensível à luz. Não a toque e não a exponha à luz ambiente normal por mais de 5 minutos.

2.

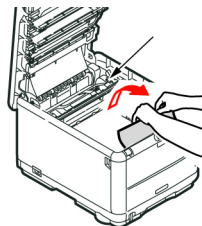
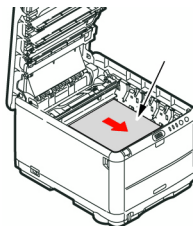

3.

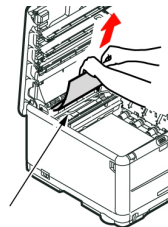
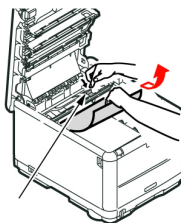

WARNING: A unidade de fusão estará quente. Não toque nesta área.

4. Se uma folha estiver parcialmente de fora na superior da impressora, agarre no folha e puxe-a com cuidado. Se não sair facilmente, a partir da parte posterior.

Resolver encravamentos de papel (cont.)

Perspectiva posterior

1.

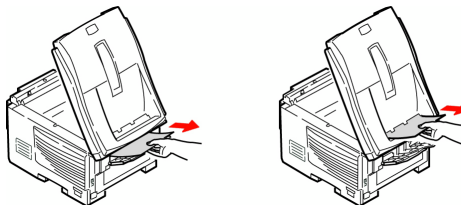

2. Se a folha estiver num local de difícil acesso, é provável que esteja presa à unidade de fusão. Levante a tampa superior, procure a folha e pressione a alavanca de liberação de pressão da unidade de fusão (1).

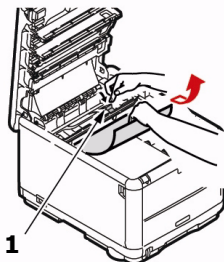

Perspectiva frontal

1.

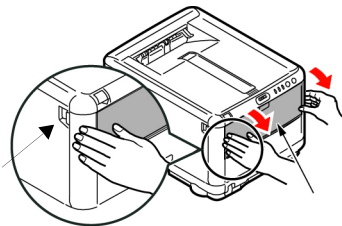

2.

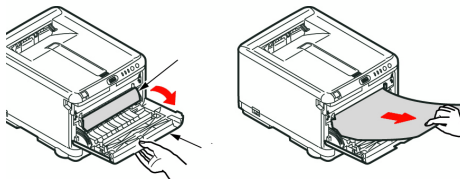

Pedidos de suprimentos de reposição

Como fazer pedidos

- Consulte o revendedor onde adquiriu a impressora.
- Consulte um representante autorizado de vendas ou assistência técnica da Oki Data. (Para se informar a respeito do revendedor mais próximo, ligue para [5511] 3444-3500).
- *Consulte os catálogos de suprimentos de escritório.*

Números para pedidos

Toners

Color	OKI Part #
Black	43459304
Cyan	43459303
Magenta	43459302
Yellow	43459301

Cilindros OPC

Color	OKI Part #
Black	43460204
Cyan	43460203
Magenta	43460202
Yellow	43460201

Fusors e esteira de transferência

Item	Oki Part #
Fuser, 120 V	43377001
Fuser, 220 V	43377002
Transfer Belt	43378001

Mídia de impressão Oki

Oki® Synflex™

- A prova d'água, Resistente à ruptura
- Branco, 8½ x 11 polegadas (216 x 279 mm)

Nº para pedidos OKI	Quantidade
52205901	100/caixa

Papel branco brilhante para provas Oki

- Branco, 32-lb.
- 8½ x 11 polegadas (216 x 279 mm)

Nº para pedidos OKI	Qty
52206101	500/caixa

Envelopes de alta qualidade Oki

- COM-10 (#10), fibras trançadas
- Tintura de segurança, selo Redi-strip!

Nº para pedidos OKI	Qty
52206301	100/caixa
52206302	500/caixa

Papel para faixas Oki

- 70 lb. Index (128 g/m²)
- Tamanho 8½ x 35.4 polegadas (216 x 899 mm)

Nº para pedidos OKI	Qty
52207901	25/caixa
52206002	100/caixa

Papel cartão de alta qualidade Oki

- Neutro com qualidade para arquivamento
- Branco 8½ x 11 polegadas (216 x 279 mm)

Nº para pedidos OKI	Weight	Qty
52205601	60 lb. Cover	250/caixa
52205602	90 lb. Index	250/caixa
52205603	110 lb. Index	250/caixa

Assistência técnica e suporte

Primeiro ...

Consulte a loja onde adquiriu a impressora.

Outros recursos da OKI

- Visite nosso site multilingüe na Web:

WWW.OKIPRINTINGSOLUTIONS.COM

- Visite **my.okidata.com** (somente em inglês).
- Ligue para 55-11-3444-6747 (grande São Paulo) ou 0800-11-5577 (demais localidades)
- e-mail: okidata@okidata.com.br.

OKI é uma marca registrada da Oki Electric Industry Company, Ltd.

3M é uma marca comercial ou marca registrada da 3M.

AmEx é uma marca registrada da American Express Co.

MasterCard é uma marca registrada da MasterCard International, Inc.

VISA é uma marca registrada da Visa.

Windows é uma marca registrada ou marca comercial da Microsoft Corporation nos Estados Unidos e em outros países.

Xerox é uma marca comercial da Xerox Corporation.