

OKI



Instruction manual

Printer controller

CP_Manager ***for E-series***

Introduction

Thank you for purchasing a ColorPainter series ink jet printer.

The CP_Manager™ software controls the ColorPainter series printers. Its functions include displaying the printer status, changing the settings, test printing, and maintenance.

The CP_Manager for E-Series software is CP_Manager software dedicated to the ColorPainter E series (IP-5630/IP-5530).

Unless otherwise specified, the CP_Manager for E-Series software will be referred to as CP_Manager in this manual.

Before using the software and printer, carefully read the software instruction manual (this document) and the printer user's guide.

After reading these manuals, carefully store them so they can be accessed when needed.

Windows® is a registered trademark or trademark of Microsoft® Corporation in the United States and other countries.

Adobe® Reader® is a registered trademark or trademark of Adobe Systems in the United States and other countries.

Other company and product names are trademarks or registered trademarks of their respective companies.

Table of Contents

Chapter 1. Overview of CP_Manager

- ◆ Basic operations 1-2
- ◆ System requirements 1-2

Chapter 2. Basics of CP_Manager

- ◆ Installation procedure 2-2
- ◆ CP_Manager operating conditions 2-4
- ◆ Starting CP_Manager 2-4
- ◆ Screen layout 2-5

Chapter 3. Printer status display area

- ◆ Printer status display area 3-2

Chapter 4. Printer setting area

- ◆ Icon explanation 4-2
- ◆ Printer operations 4-4
- ◆ Printer maintenance 4-5
- ◆ Media adjustment 4-6
- ◆ Media preset 4-8
- ◆ Heater settings 4-10
- ◆ Maintenance 4-11
- ◆ Mechanical adjustment 4-12
- ◆ Useful tool 4-13
- ◆ Notification 4-14
- ◆ Settings 4-18
- ◆ Printer information 4-19

What is CP_Manager? (Useful Functions)

The CP_Manager software is used to display the printer status, configure the printer settings and perform maintenance operations without using the printer operation panel.

The printer settings are displayed in a user-friendly manner to facilitate configuration, even for users who operate the printer for the first time.

An electronic version of the maintenance manual is also available.

Moreover, CP_Manager can warn and notify you of the printer status through sounds and messages sent by e-mails.

CP_Manager for E-series is compatible with the following printers.

- ColorPainter E series (IP-5630/IP-5530)

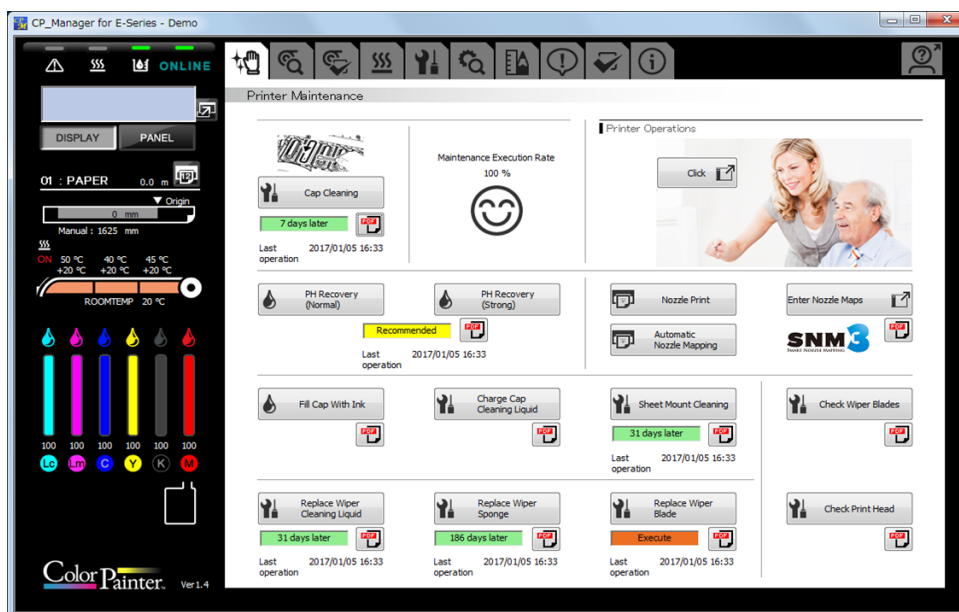

◆ An enhanced interface to facilitate entry of value and detailed settings

Entering values and modifying the settings are simple.

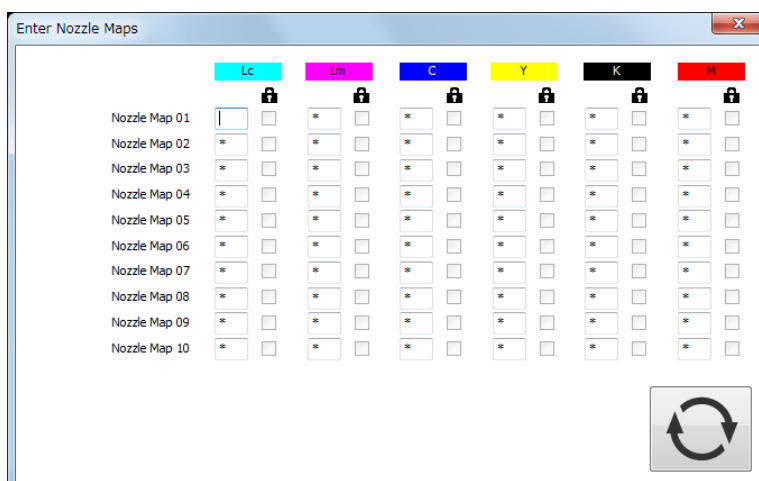

-
- ◆ The status of the printer can be displayed on a computer to allow the user to stay away from the printer.

Checking the printer status

The status of the printer can be checked from a computer.

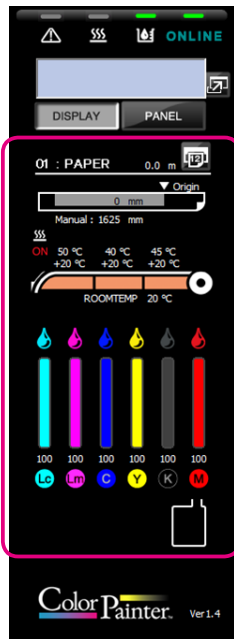

- ◆ The virtual panel makes it possible to control the printer remotely

Operations on a computer can be performed the same way as on the printer operation panel.

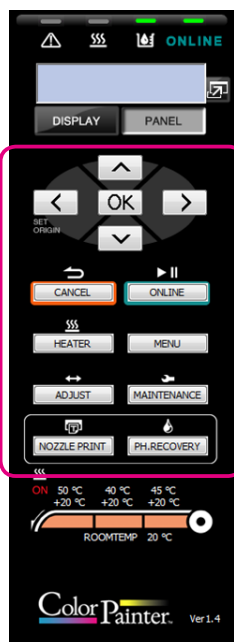

◆ **The sound warning function notifies you when the print has finished or when an error occurs**

Configure the warning sound to be notified when the print has finished or when an error has occurred.

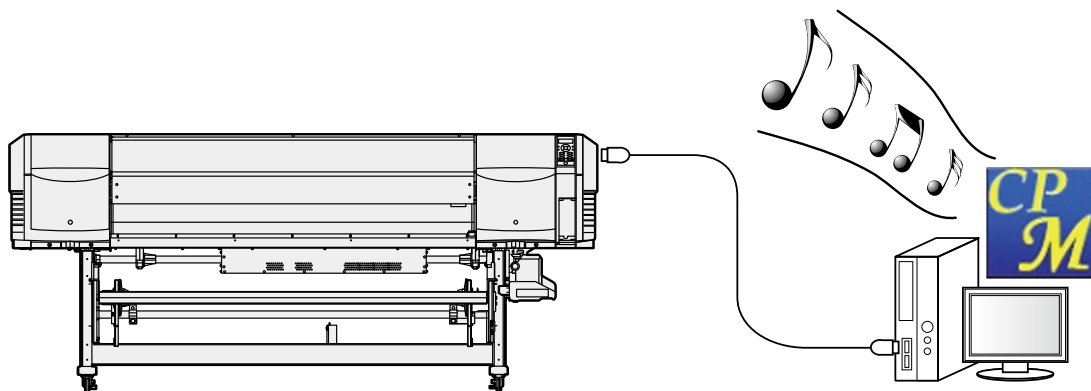

◆ **E-mail function to notify the printer status remotely**

Notifications on the printer status are sent to you by e-mail.

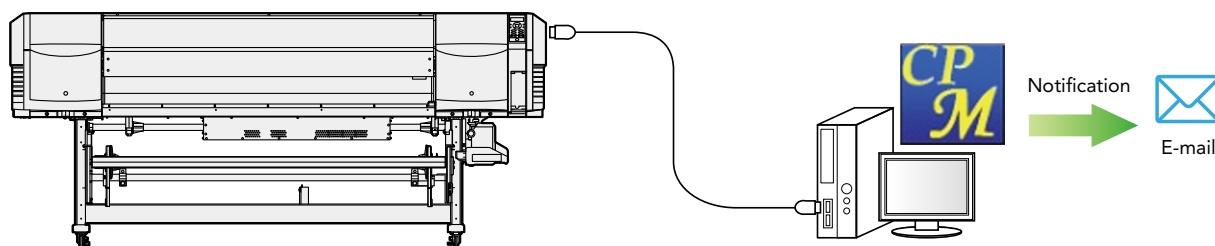

Chapter 1

Overview of CP_Manager

- ▽ Basic operations1-2
- ▽ System requirements1-2

Chapter 1. Overview of CP_Manager

Basic operations

CP_Manager can perform the following operations.

Display printer status	- Printer status - Media information - Amount of ink remaining - Heater information - Ambient temperature - Information about the connected printer, etc.
Change settings	- Media preset - Heater status - Media adjustment - Mechanical adjustment - Nozzle map
Maintenance operations	- Regular maintenance - Other maintenance items - Replacement of consumables, etc.
Test printing	- Nozzle printing - Adjustment pattern printing
Printer operations	- Explanations on each maintenance operation - Explanations about troubleshooting - Display of manuals
Acquire log information	Acquire printer log information and save it as a file
Panel operation	Operate the printer panel keys (virtual panel function)
Notify printer status	Notify the status via e-mail function

System requirements

The CP_Manager software is designed to control ColorPainter series printers and runs on Microsoft Windows®.

Operating System

Windows 7	32-bit/64-bit version (runs as a 32-bit application on the 64-bit version)
Windows 8	32-bit/64-bit version (runs as a 32-bit application on the 64-bit version)
Windows 10	32-bit/64-bit version (runs as a 32-bit application on the 64-bit version)

Software

Adobe® Reader® Version 8. 1.3 (or higher)
Windows printer driver

Chapter 2

Basics of CP_Manager

▽ Installation procedure	2-2
▽ CP_Manager operating conditions	2-4
▽ Starting CP_Manager	2-4
▽ Screen layout	2-5

Chapter 2. Basics of CP_Manager

Installation procedure

Warning

- Close all programs before installing the software.
- Log in as a user with administrative privileges to install the software and driver software.
- Be sure to refer to all the instruction manuals included in the Document folder on the CD-ROM.

Install CP_Manager for E-Series

1-1. Start the setup screen

Insert the included setup CD-ROM into the CD-ROM drive of the computer and run **OKI CP_Manager for E-Series_VX.XX.exe** in the **CP_Manager for E-Series** folder.

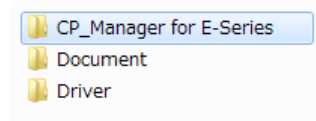

1-2. Start the installer

The Welcome to the CP_Manager for E-Series Setup Wizard screen appears. Click **Next**.

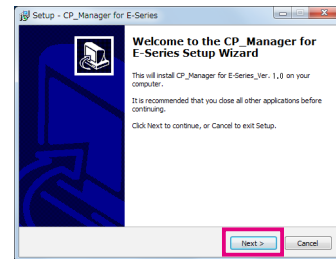

1-3. Agree to the software license agreement

The software license agreement screen appears. To agree to the software license agreement, check **I accept the agreement** and then click **Next**.

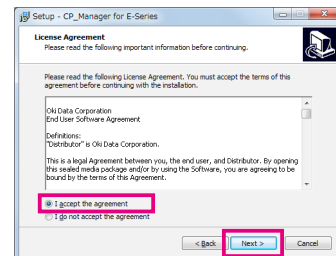

1-4. Enter user information

The user information input screen appears. Enter the required information and click **Next** to continue.

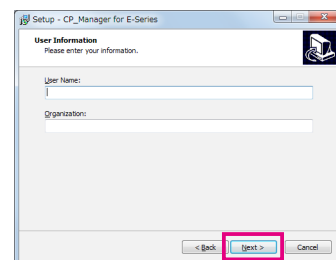

1-5. Specify the installation location

The installation location selection screen appears. Specify an installation location and click **Next** to continue. (Note: To change the installation location, click Browse and then select a folder.)

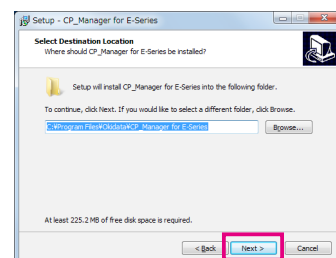

1-6. Specify the folder to save the data

The saved data folder selection screen appears. Select a folder to save the data and click **Next** to continue.

(Note: To change the location to save the data, click Browse and then select a folder.)

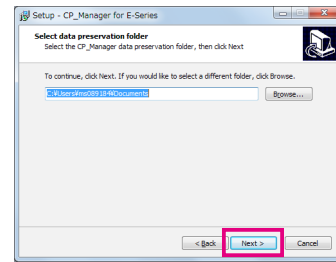
**1-7. Specify the program group**

The program group creation screen appears. Specify a location to create the program group and click **Next** to continue. (Note: To create the program group in a different location, click Browse and then select a folder.)

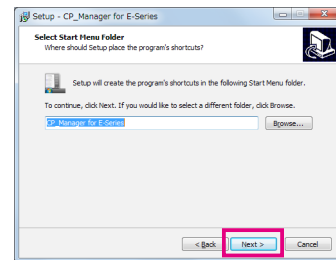
**1-8. Start the installation**

The installation preparation is finished. Click **Install** to start the installation. Wait until the installation finishes.

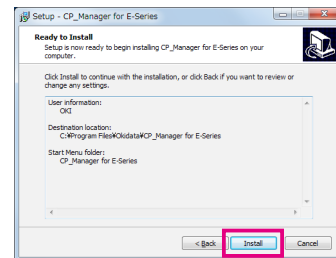
**1-9. Complete the installation**

When the installation has finished, click **Finish** to complete the procedure.

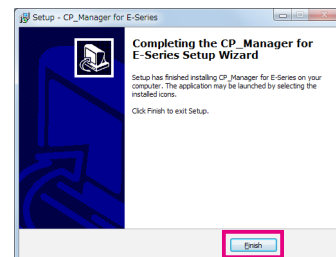
**Important points about starting CP_Manager**

- Switch on the power of the printer and let the printer start before launching CP_Manager.
- If the printer has not yet started or the connection to the printer cannot be found, CP_Manager enters demonstration mode.
- The units (length and temperature) displayed in CP_Manager match those registered with the printer. Therefore, it is not necessary to set the units in CP_Manager.

Note that the printer settings are only checked when CP_Manager starts. If you change the printer settings, restart CP_Manager.

- The default language displayed in CP_Manager matches the printer setting. However, you can change the CP_Manager language to a setting different from the printer. CP_Manager must be restarted after changing the language setting.

CP_Manager operating conditions

CP_Manager operations	Printer status
Displaying the printer status	Always possible
Changing the settings	Possible only when online (idle mode)
Performing maintenance	Possible only when online (idle mode)
Testing printing	Possible only when online (idle mode)
Troubleshooting	Always possible
Acquire log information	Possible only when online or offline (idle mode)
Panel key operations	Always possible

Starting CP_Manager

From the computer desktop, double-click the **CP_Manager for E-Series shortcut icon**. Alternatively, click **Start**, point to **All Programs, CP_Manager for E-Series**, and then click **CP_Manager for E-Series**.

Screen layout

CP_Manager is composed of two display areas.

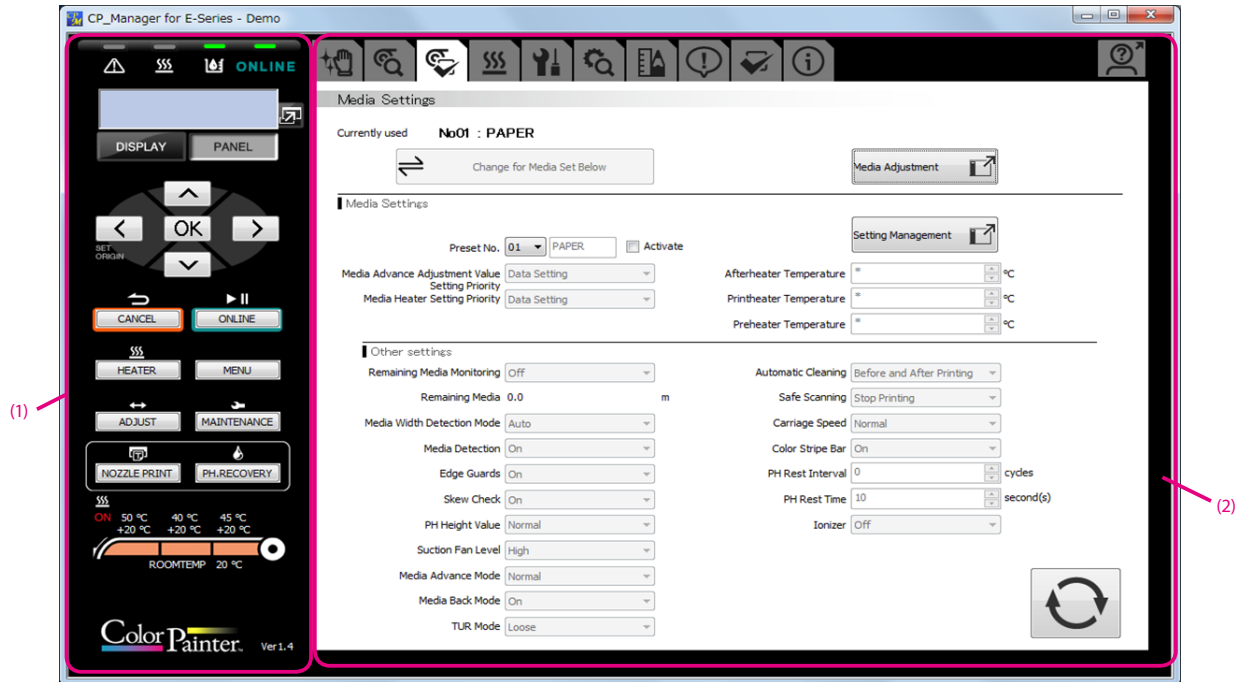

(1) Printer status display area

This area displays information regarding the printer status, such as the panel information, the remaining ink, and the temperatures. This area also displays the virtual panel used to operate the printer panel in CP_Manager.

(2) Printer setting area

In this area you can change the printer settings, such as media presets and adjustment values, and execute cleaning and other maintenance operations.

Chapter 3

Printer status display area

▽ Printer status display area.....	3-2
------------------------------------	-----

Chapter 3. Printer status display area

Printer status display area



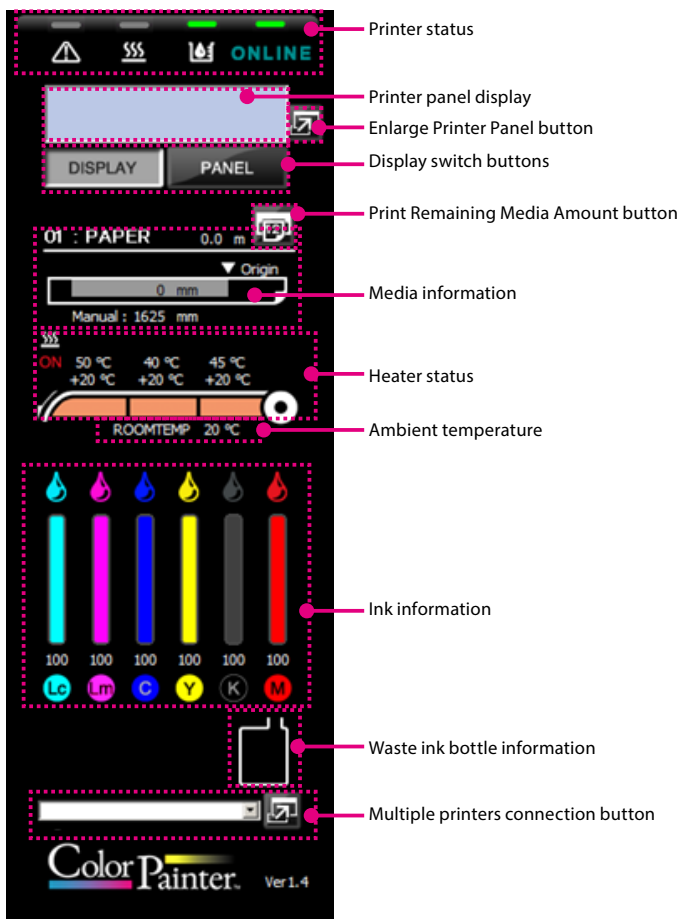

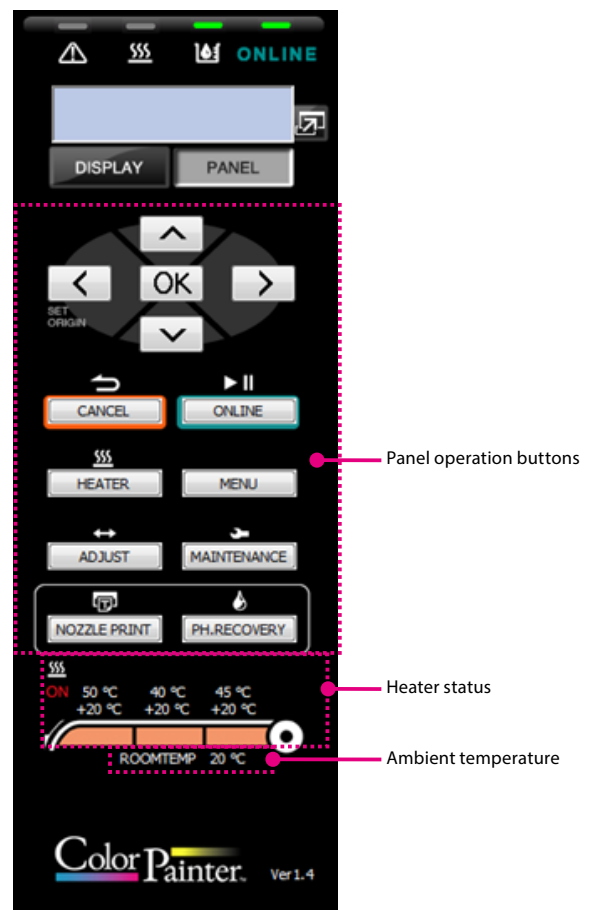

<Printer information display>



<Panel operation display>

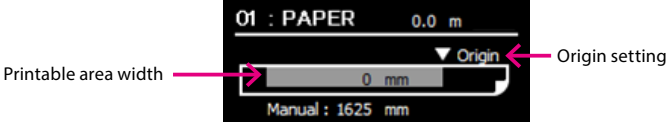

<Printer information display>

	Description
Printer Status	<p>Online indicator </p> <p>On: Online, Off: Offline</p> <p>Flashing (fast): Receiving data, Flashing (slowly): In pause</p> <p>Ink indicator </p> <p>On: Normal, Flashing: Ink warning, Off: Ink error</p> <p>Heater indicator </p> <p>On: All media heaters reached the set temperatures, Flashing: Media heaters currently heating</p> <p>Off: All media heaters are turned off</p> <p>Error indicator </p> <p>Off: No error, Flashing: Warning, On: Error</p>
Printer panel display	<p>Displays the printer panel.</p> <p>*This can be used as a virtual panel if the area is switched to panel operation display.</p>
Enlarge Printer Panel button	Button used to enlarge the printer panel.
Display switch buttons	<p>Buttons used to switch between the printer information display and the panel operation display.</p> <p>Display: Printer information display</p> <p>Panel: Panel operation display</p>
Print Remaining Media Amount button	Button used to print the remaining amount of the currently installed media.
Media information	<p>Displays information about the currently used media</p> <p style="text-align: center;">Preset number: Media name Remaining length</p> <div style="text-align: center;">  </div> <p>When the media width detection mode is set to AUTO: Media width</p> <p>When the media width detection mode is set to MANUAL: Manual: Media width</p>
Heater status	<p>Upper: Set temperature</p> <p>Lower: Current temperature (the "+" mark indicates the heater is currently heating)</p> <p>All heaters ON indicator </p> <p>Indicates that all heaters are on when displayed.</p>
Ambient temperature	Ambient temperature
Ink information	<p>During cleaning, a mark () indicating that the ink is currently used is displayed above the corresponding ink color.</p> <p>Amount remaining for each ink color (%)</p>
Waste ink bottle information	Indicates the waste ink bottle status (5 levels)
Multiple printers connection button	<p>Button used to launch an additional instance of CP_Manager when more than one printer is connected.</p> <p>*Displayed only when multiple printers are connected.</p>

<Panel operation display>

	Description
Panel operation buttons	Same buttons as on the printer panel
Heater status	<p>Upper: Set temperature</p> <p>Lower: Current temperature (the "+" mark indicates the heater is currently heating)</p> <p>All heaters ON indicator </p> <p>Indicates that all heaters are on when displayed.</p>
Ambient temperature	Ambient temperature

Chapter 4

Printer setting area

▽ Icon explanation	4-2
▽ Printer operations	4-4
▽ Printer maintenance	4-5
▽ Media adjustment.....	4-6
▽ Media preset	4-8
▽ Heater settings	4-10
▽ Maintenance	4-11
▽ Mechanical adjustment	4-12
▽ Useful tool.....	4-13
▽ Notification	4-14
▽ Settings	4-18
▽ Printer information	4-19

Chapter 4. Printer setting area





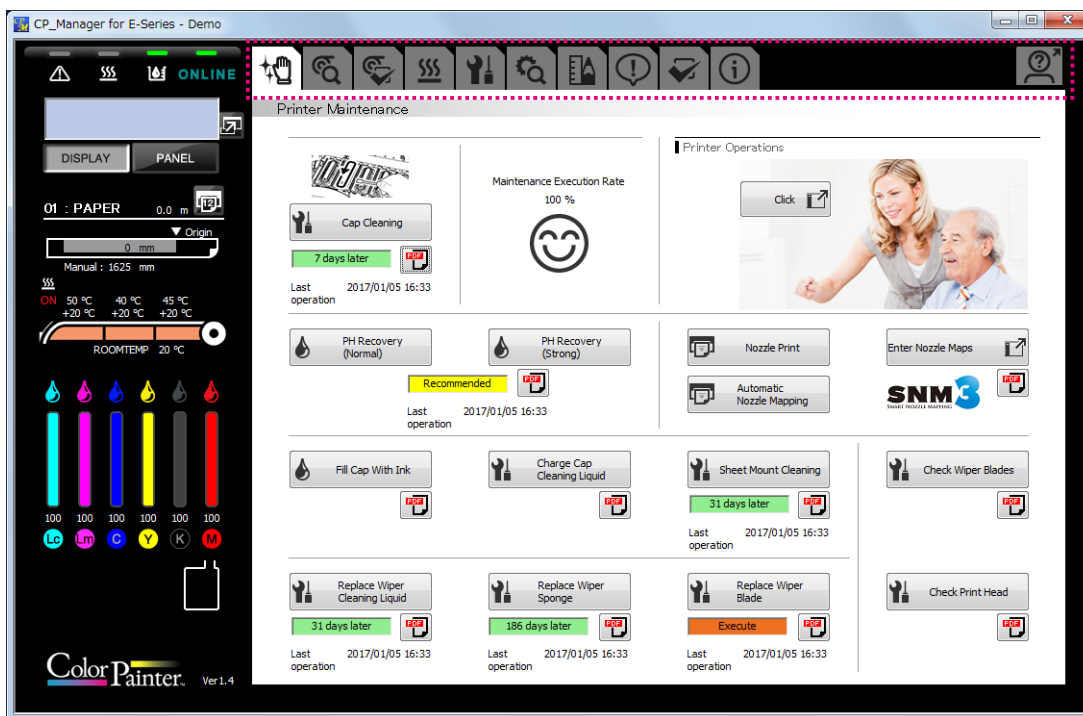

Icon explanation





The CP_Manager software includes 11 main screens.

You can switch between the different screens by selecting one of the icons displayed at the top of the screen.



The icons and the screens that are displayed are described below.

Icon	Description of the corresponding screen
 Printer Maintenance	Screen used to perform cap cleaning, cleaning, nozzle print, nozzle maps, consumable replacement and other daily maintenance operations required to use the printer.
 Media Adjustment	Screen used to adjust the settings, such as media advance adjustment and bidirectional adjustment (automatic or manual) to match the media when a new type of media is installed.
 Media Settings	Screen used to configure settings for each type of media.
 Heater Settings	Screen used to configure settings, such as temperature and timer, related to the heaters.
 Maintenance	Screen used to perform printer maintenance operations, such as filling ink system with ink and head wash.
 Mech Adjustment	Screen used to adjust the printer characteristics.

Icon	Description of the corresponding screen
 Useful tool	Screen used to calculate print times.
 Notification	Screen used to configure the notification function. End of printer operations or change in printer status (such as errors or alarms) can be notified using sounds or by e-mail.
 Settings	Screen used to configure CP_Manager and printer settings.
 Printer Info	Screen used to display printer information as a list.
 Printer Operations	Screen displaying explanations on different operations, troubleshooting and links to open instruction manuals. *A separate pop-up window is displayed when this button is pressed.

Printer operations

The following operations can be performed in this mode.

- Display of explanations on printer operations
- Display of explanations on troubleshooting methods
- Display of manuals

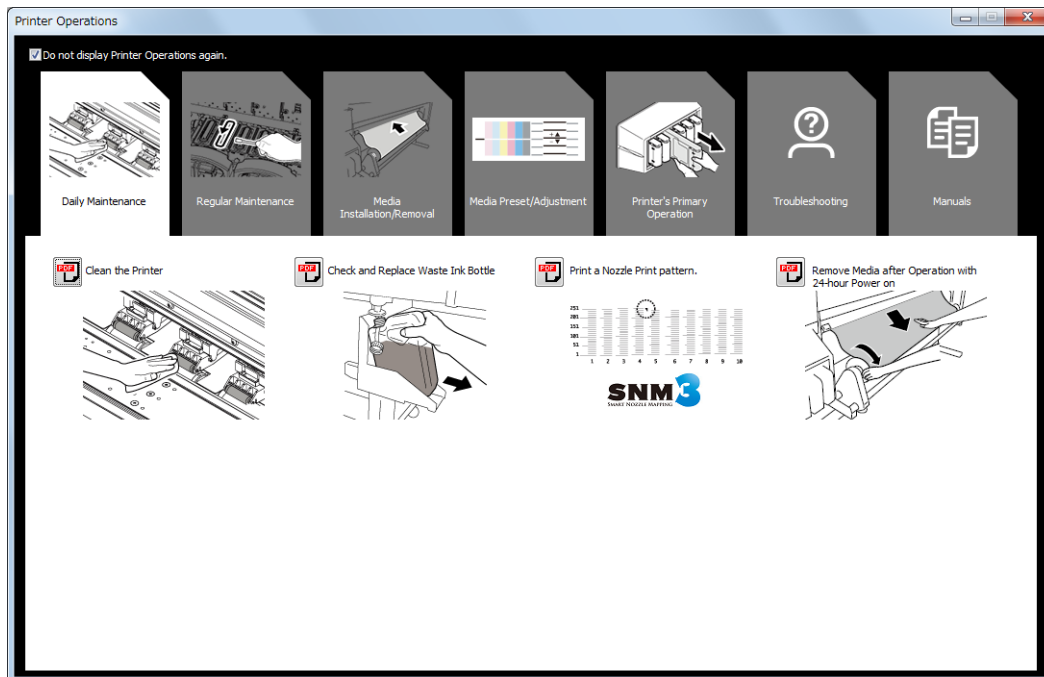

Printer maintenance

The following operations can be performed in this mode.

- Maintenance operations
- Display of cap cleaning execution rate
- Display of printer operations
- Setting of nozzle maps
- Replacement of consumables, etc.

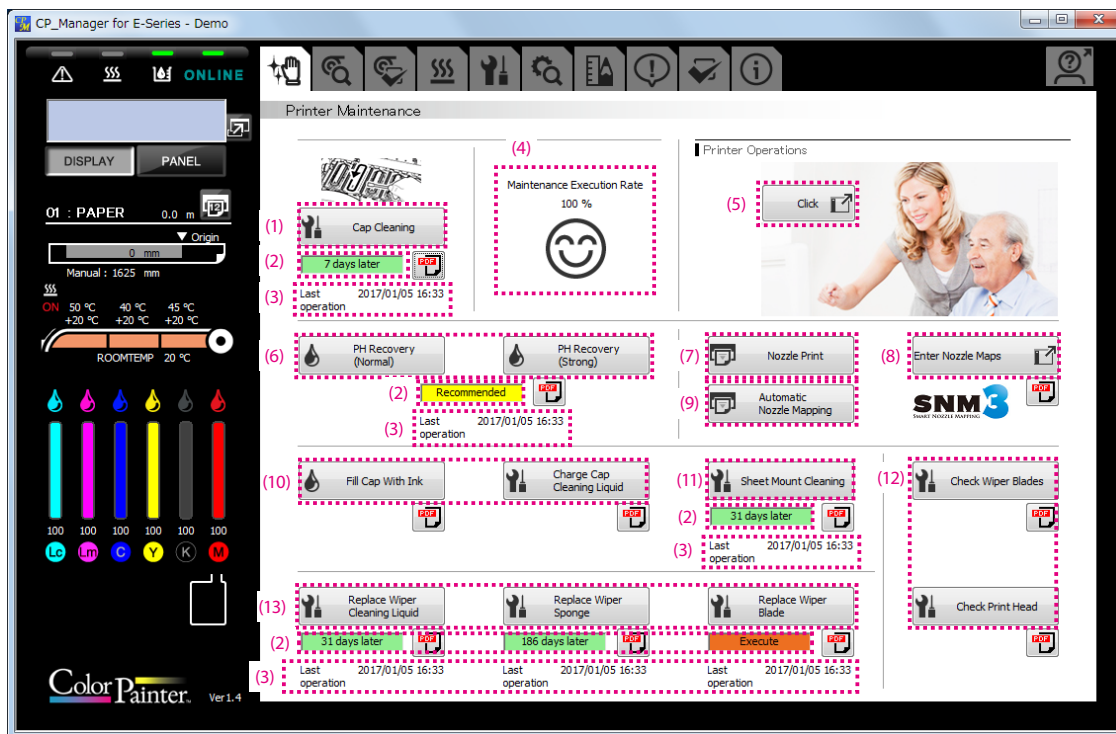

- | | |
|---|---|
| (1) Cap Cleaning button: | Execute cap cleaning. |
| (2) Time until next maintenance: | Click to display the time until next maintenance. |
| (3) Last operation: | Displays the date and time of the last maintenance operations. |
| (4) Execution rate: | Displays the execution rate of cap cleaning. |
| (5) Printer Operations button: | Displays explanations on printer operations. |
| (6) PH Recovery buttons: | Execute PH recovery (cleaning of the print heads). |
| (7) Nozzle Print button: | Execute nozzle print. |
| (8) Enter Nozzle Maps button: | Button used to enter nozzle maps. |
| (9) Automatic Nozzle Mapping button: | Execute automatic nozzle map. |
| (10) Clogged nozzles recovery buttons: | Buttons used to recover the clogged nozzles. |
| (11) Sheet mount cleaning execution button: | Click to execute sheet mount cleaning. |
| (12) Daily maintenance buttons: | Buttons used to perform daily printer checks or printer cleaning. |
| (13) Consumable replacement buttons: | Buttons used when replacing consumable parts of the wiper. |

Media adjustment

Adjustment can be made for each media used.

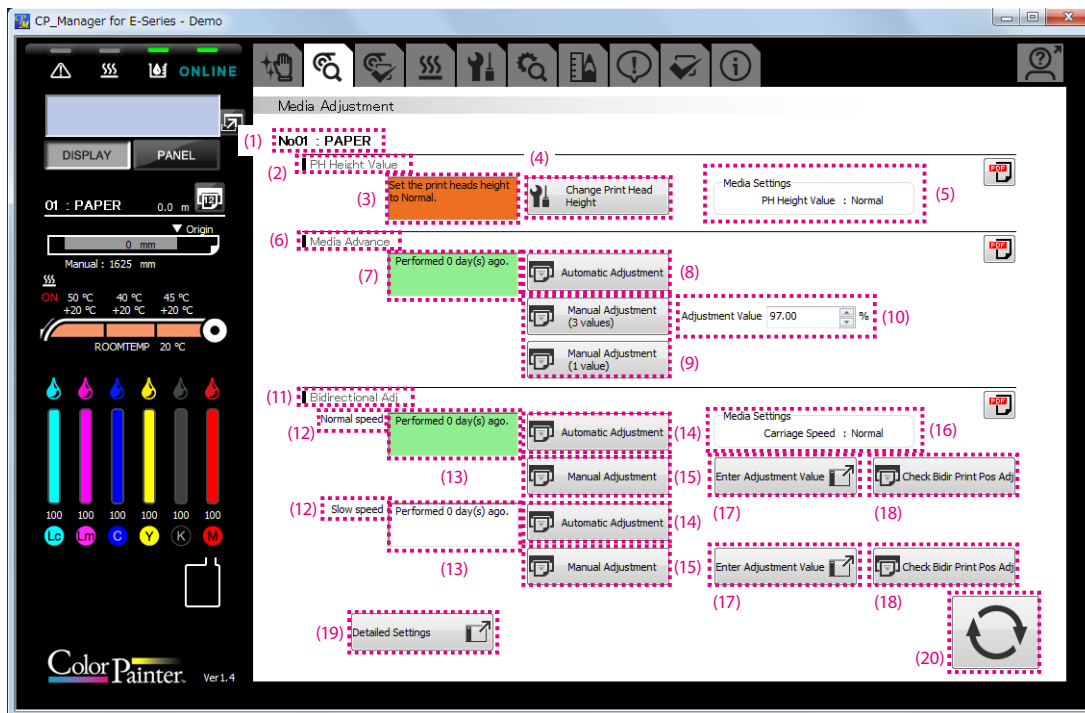

- | | |
|---|---|
| (1) Preset No., Media name: | Number and name of the media for which adjustment is performed. |
| (2) PH Height: | Menu used when changing the height of the print heads. |
| (3) Notification field for print head height change: | You are notified of the need to change the height of the print heads in this field when the print head height configured in the media preset does not match the print head height configured in the printer. |
| (4) Change Print Head Height button: | Button used to change the height of the print heads. |
| (5) Information on print head height setting: | Displays the height setting for the print heads in the preset of the media that is being adjusted. |
| (6) Media Advance: | Menu used to perform media advance adjustment. |
| (7) Notification field for media advance adjustment: | You are notified of the need to perform media advance adjustment in this field. |
| (8) Automatic Adjustment button: | Button used to execute automatic media advance adjustment. With automatic media advance adjustment, the adjustment value is set automatically. |
| (9) Print buttons for manual media advance adjustment patterns: | Buttons used to print media advance adjustment patterns. The patterns are printed based on the adjustment value set in (10). Check the print results visually. If the print output is still misaligned, change the adjustment value and print the adjustment patterns again.
*After changing the adjustment value in (10), you must apply the setting with the update settings button (20) before printing the patterns. |
| (10) Input field for media advance adjustment value: | Field used to input the media advance adjustment value. After changing the adjustment value, apply the setting with the update settings button (20). |
| (11) Bidirectional Adj.: | Menu used to perform bidirectional adjustment. |
| (12) Carriage speeds: | Menus used to configure bidirectional adjustment with normal and slow carriage speeds. |
| (13) Notification fields for bidirectional adjustment: | You are notified of the need to perform bidirectional adjustment in these fields. The need to perform adjustment is displayed for each carriage speed. |
| (14) Automatic Adjustment buttons: | Buttons used to perform automatic bidirectional adjustment. With automatic bidirectional adjustment, the adjustment value is set automatically. |

- (15) Manual adjustment buttons: Buttons used to print bidirectional adjustment patterns. Check the print results visually and choose an adjustment value. Then enter the adjustment value using the Enter Adjustment Value button (18).
- (16) Information on carriage speed: Displays carriage speed setting in the preset of the media being adjusted
- (17) Enter Adjustment Value buttons: Buttons used to enter bidirectional adjustment values. Clicking these buttons opens a window where you can enter adjustment values for each color. After entering the adjustment values, apply the settings with the update settings button (20).
*The entered values are not set if you do not click the update button (20).
- (18) Print buttons for bidirectional check patterns: Buttons used to print bidirectional adjustment check patterns. After you have performed bidirectional adjustment, print and check visually the check pattern to confirm that the adjustment results are correct.
- (19) Detailed Settings button: Button used to perform adjustment under every print condition using a detailed setting menu when print output is still misaligned after performing automatic and manual bidirectional adjustment.
- (20) Update settings button: Button used to send and set the media advance adjustment and bidirectional adjustment values to the printer.

Detailed settings for bidirectional adjustment

Detailed settings are used to perform bidirectional adjustment with specific print conditions (print mode and carriage speed). Automatic and manual adjustment methods are available.

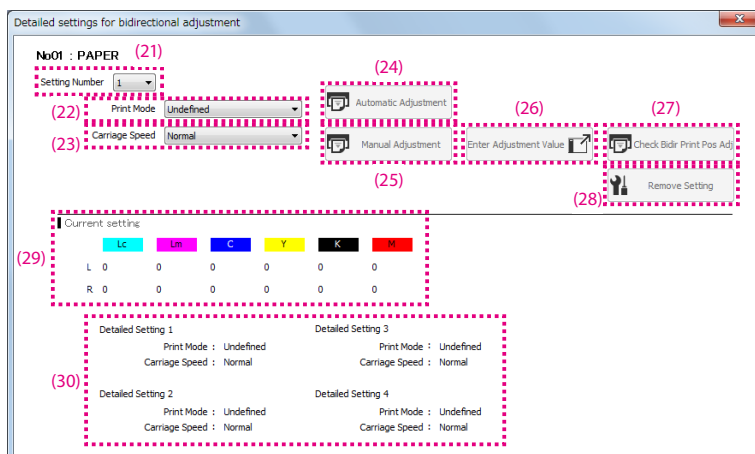

- (21) Setting Number: Number of the detailed setting (1 to 4).
- (22) Print mode: Field used to specify the print mode for detailed setting adjustment. Detailed settings are disabled when Undefined is selected.
- (23) Carriage speed: Field used to specify the carriage speed for detailed setting adjustment.
- (24) Automatic Adjustment button: Button used to execute automatic adjustment. With automatic bidirectional adjustment, the adjustment value is set automatically.
- (25) Manual Adjustment button: Button used to print the bidirectional adjustment pattern. Check the print results visually and choose an adjustment value. Then enter the adjustment value using the Enter Adjustment Value button (27).
- (26) Enter Adjustment Value button: Button used to enter bidirectional adjustment values. Clicking this button opens a window where you can enter adjustment values for each color. After entering the adjustment values, apply the settings with the update settings button.
*The entered values are not set if you do not click the update button.
- (27) Print button for bidirectional check patterns: Button used to print bidirectional adjustment check patterns. After you have performed bidirectional adjustment with detailed settings, print and check visually the check pattern to confirm that the adjustment results are correct.
- (28) Remove Setting button: Button used to remove the settings in the currently selected detailed setting. Clicking this button disables the detailed setting.
- (29) Current setting field: Displays the bidirectional adjustment values currently set for the selected detailed setting.
- (30) Print condition field: Displays the print conditions specified for each detail setting.

Media preset

The following operations can be performed in this mode.

- Configure a media preset
- Write media preset settings to a file

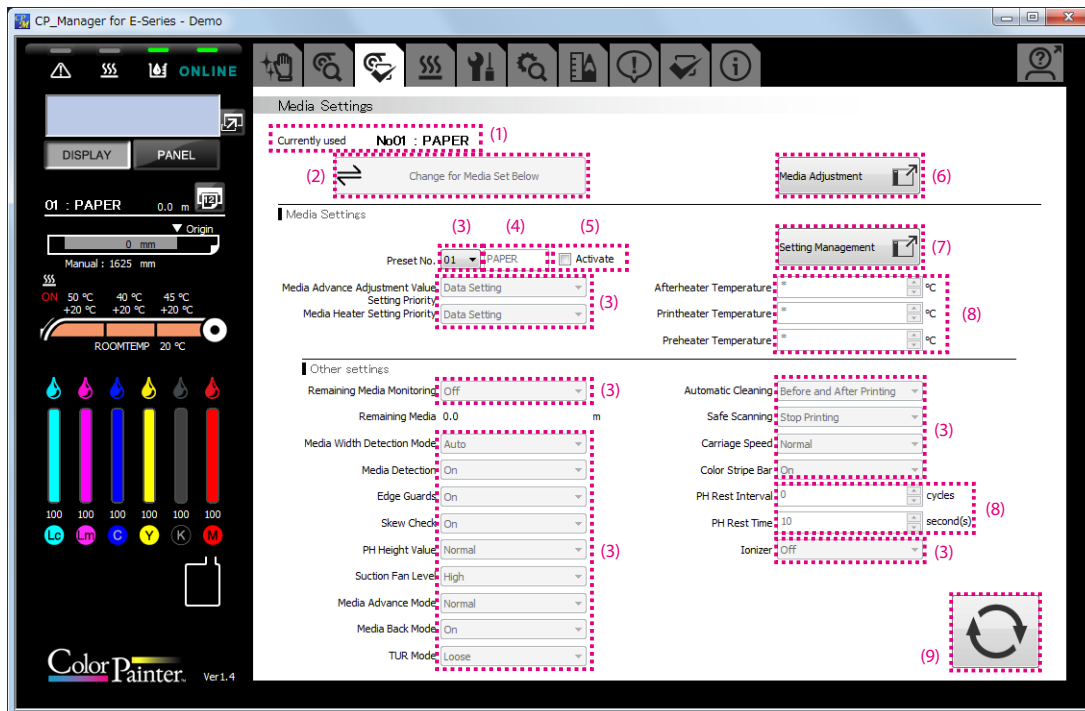

- | | |
|--|---|
| (1) Currently used media: | Displays information (preset number and media name) about the currently used media. |
| (2) Change for Media Set Below button: | Button used to replace the settings of the media currently installed with the settings displayed in CP_Manager. |
| (3) Pull-down lists: | Used to select a parameter from a list. |
| (4) Text box: | Used to enter a character string using the keyboard. |
| (5) Activate check box: | Used to activate the preset currently being displayed. |
| (6) Media Adjustment button: | Button used to go to the media adjustment screen (see Media adjustment). |
| (7) Setting Management button: | Button used to manage media settings. |
| (8) Numeric Up/Down boxes: | Used to enter numerical values directly or using the Up/Down buttons. |
| (9) Update settings button: | Button used to send the media preset settings to the printer and set the setting values. |

Media setting management

The following operations related to media presets can be performed in this mode.

- Copy of media preset
- Saving of media preset settings on a computer
- Loading of media preset settings from a computer

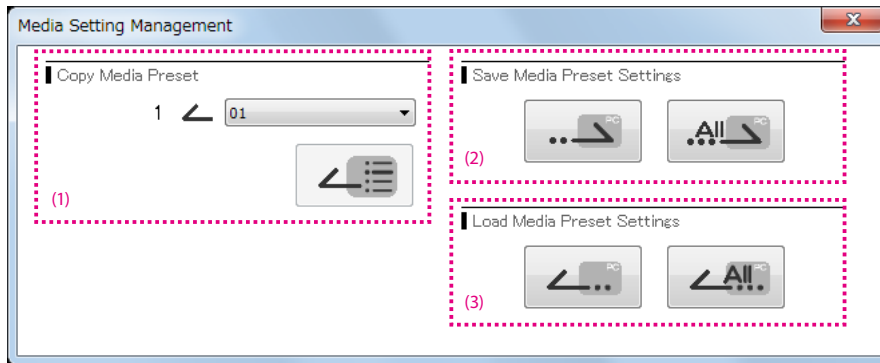

- | | |
|---|---|
| (1) Copy Media Preset button: | Button used to copy the settings of the media preset whose number has been specified to the media preset currently being updated. |
| (2) Save Media Preset Settings buttons: | Buttons used to save the media preset settings to a specified file. |
| (3) Import Media Preset Settings buttons: | Buttons used to import the media preset settings from a specified file. |

Heater settings

The heater settings can be changed in this mode.

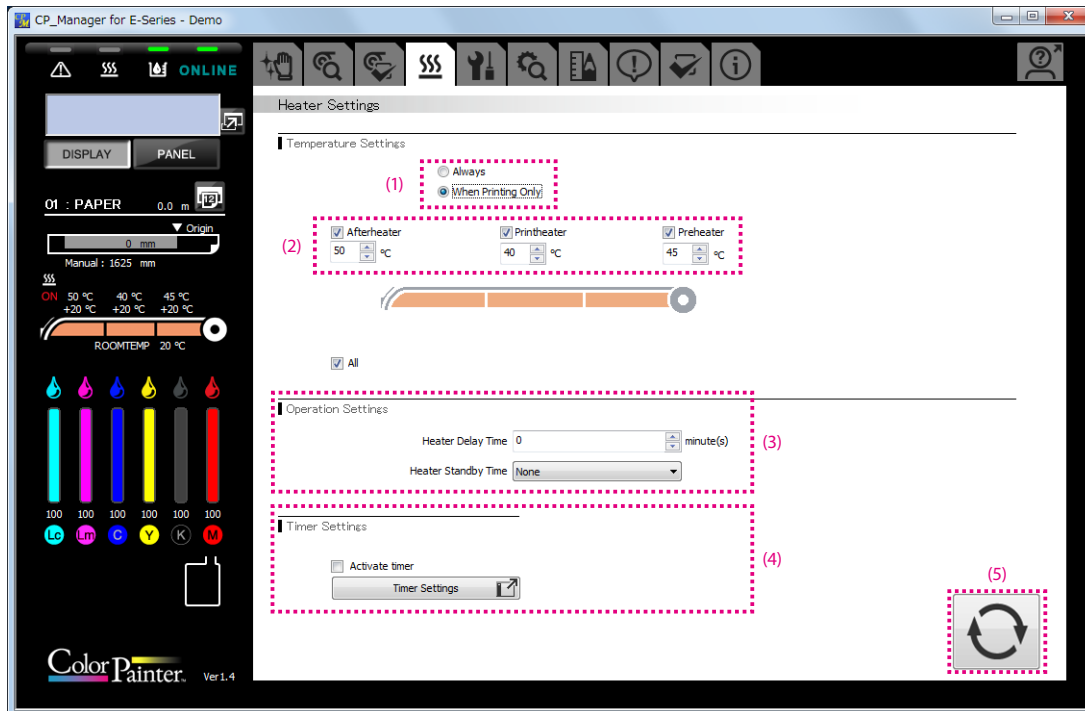

- | | |
|--------------------------------------|--|
| (1) Heater on check boxes: | Check a box to select the operation mode for the heaters. |
| (2) Heater set temperatures: | Set the temperatures by entering a value or using the up and down buttons. |
| (3) Heater Operation Settings field: | Set the Heater Delay Time and the Heater Standby Time. |
| (4) Heater Timer Settings field: | Configure heater operations during the day. Check the Activate timer box to activate the heater timer.
*Deactivate the heater timer if you want to control the timer manually.
(When the heater timer is activated, the heaters turn on and off following a fixed interval based on the on/off setting configured with the function. The heater timer setting is prioritized.) |
| (5) Update settings button: | Send the heater settings to the printer and update the printer settings. |

Maintenance

This mode is used to perform maintenance operations such as filling ink system with ink and head wash.

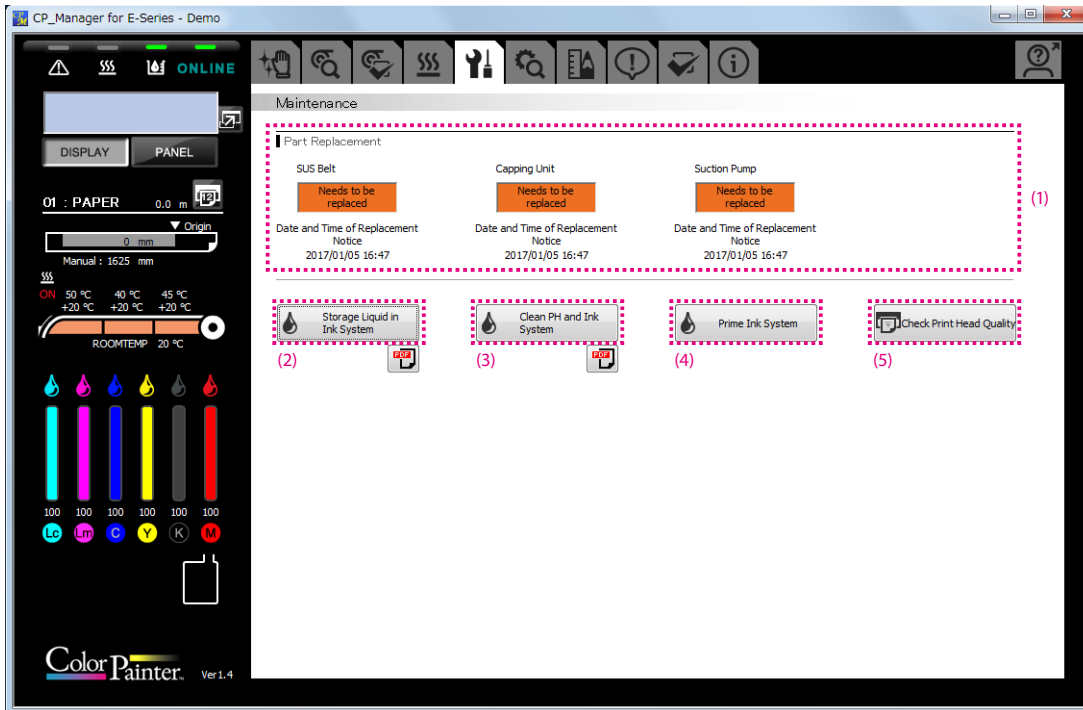

- | | |
|---------------------------------------|---|
| (1) Part Replacement: | Field displaying the necessity of replacing parts. |
| (2) Storage Liquid Ink System button: | Button used to execute service cleaning, i.e. to fill the ink system with storage liquid. |
| (3) Clean PH and Ink System button: | Button used to execute head wash, i.e. to clean the print head and ink system. |
| (4) Prime Ink System button: | Button used to fill the ink system with ink. |
| (5) Check Print Head Quality button: | Button used to print a pattern to check that print head replacement has been performed correctly. |

Mechanical adjustment

Printer characteristics can be adjusted in this mode.

Caution

- You are recommended not to change the settings on the Mech Adjustment tab. All the settings were already adjusted during the printer installation. So usually they do not need to be adjusted any more.

Exceptionally, the settings may be adjusted to reduce color misalignment, but only if the problem is not solved with media advance adjustment and bidirectional print position adjustment. However, note that this adjustment may cause misalignment for the other colors or a printer malfunction.

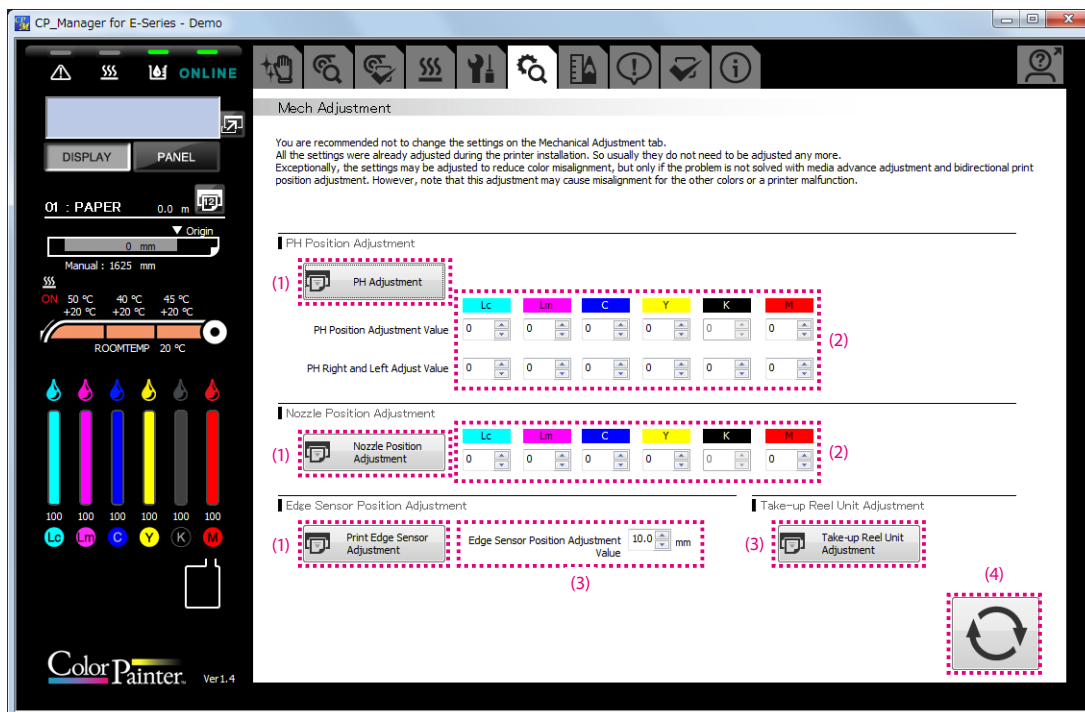

- | | |
|--|--|
| (1) Test printing button: | Click to print various adjustment patterns. |
| (2) Entry box: | Enter a value using the keyboard or the up and down buttons. |
| (3) Take-up Reel Unit Adjustment button: | Button used to print adjustment pattern for the take-up reel unit. |
| (4) Update settings button: | Send the print heads position adjustment values, the nozzles position adjustment values, and the edge sensors position adjustment values to the printer and update the printer settings. |

Useful tool

This mode is used calculate print times.

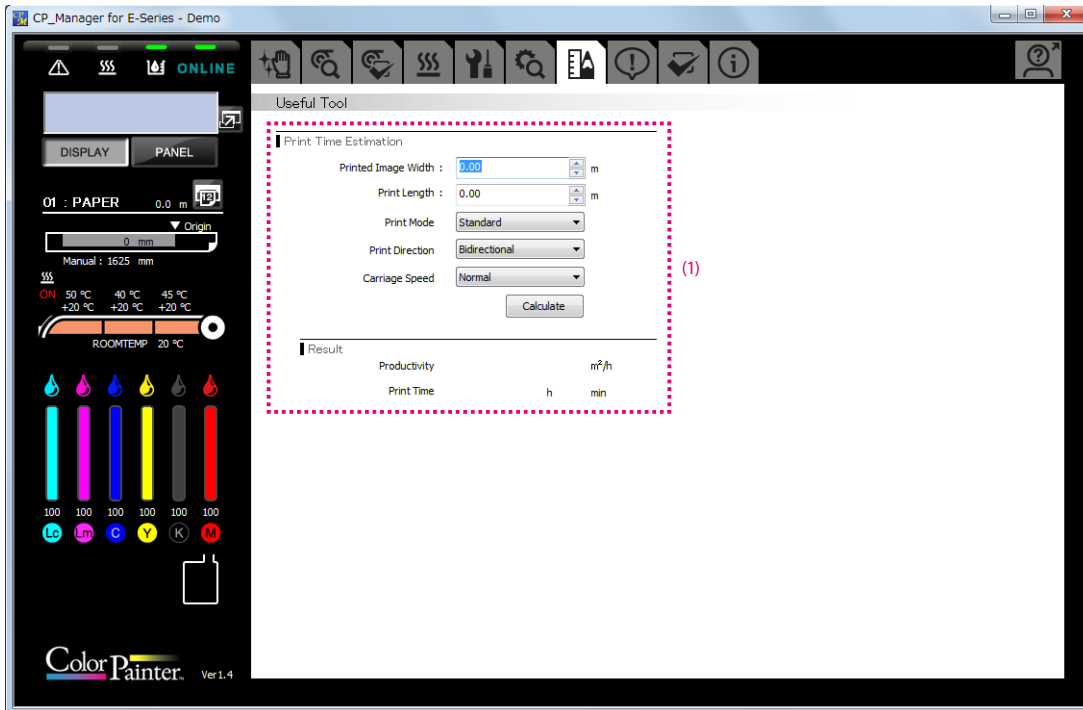

- (1) Print Time Estimation field: Field used to calculate an estimation of the print time and productivity by entering the width and length of the image to print.

Notification

This mode is used to configure the following CP_Manager notification functions.

- Notification via sound and e-mail settings
- Notification via sound and e-mails

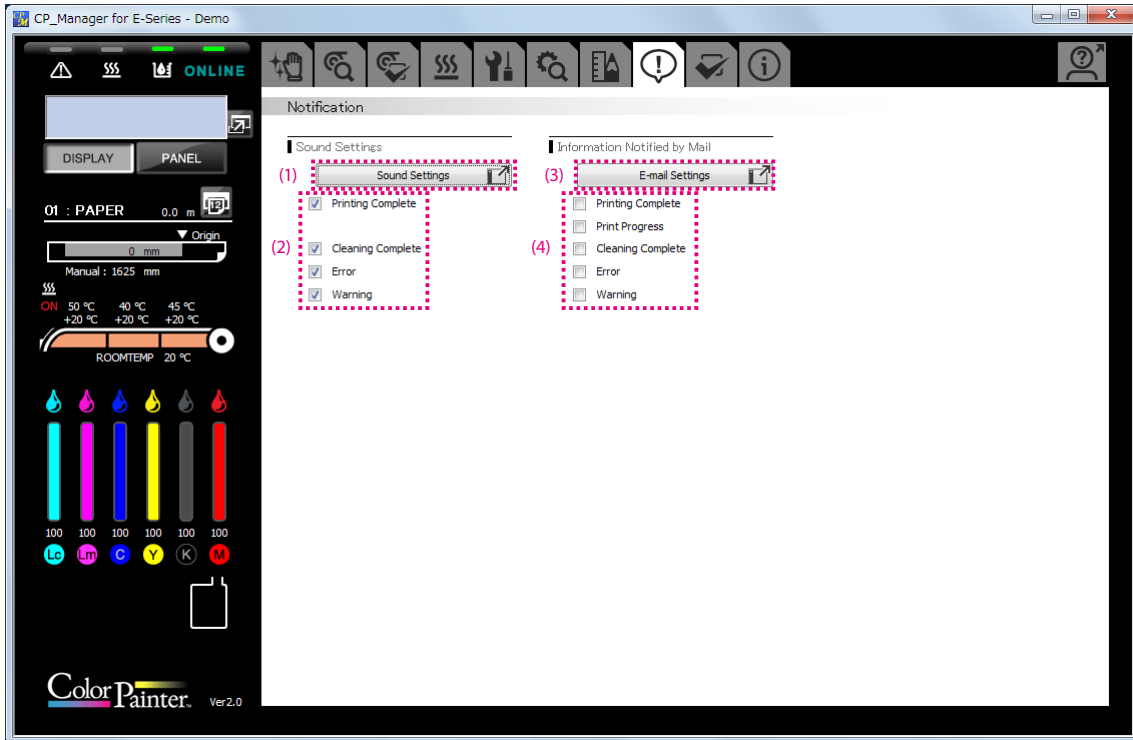

- | | |
|---|--------------------------------|
| (1) Sound settings button: | Configure the sound settings. |
| (2) Select the events to be notified with sounds. | |
| (3) E-mail settings button: | Configure the e-mail settings. |
| (4) Select the events to be notified by e-mails. | |

Sound settings

You can change the sounds to your favorite one in the WAVE format.

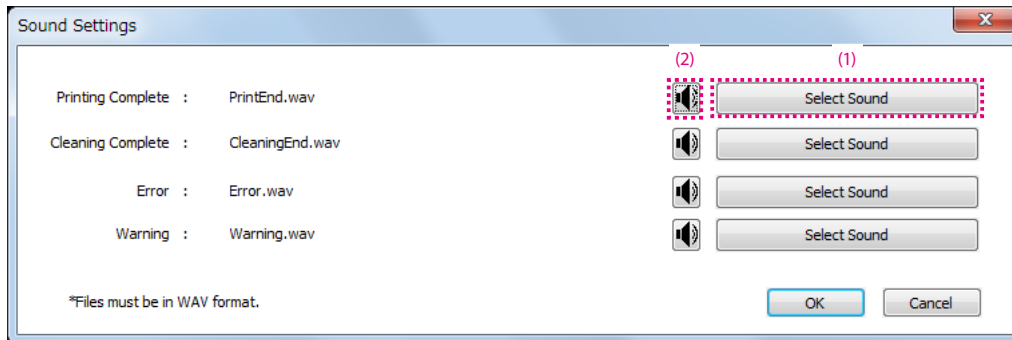

- (1) Click the Select Sound button (1) of the sound you want to change.
- (2) Select a sound in the WAVE format.
- (3) Click the button (2) of the sound you want to listen to.

■ About the e-mail function

Information about a print job progress and the printer status can be notified to a computer or a mobile device via e-mail.

E-mail addresses must be available to use this function.

To use the e-mail function the following two addresses (accounts) are necessary.

- An address to be used by CP_Manager
- An address that will receive the e-mail notifications

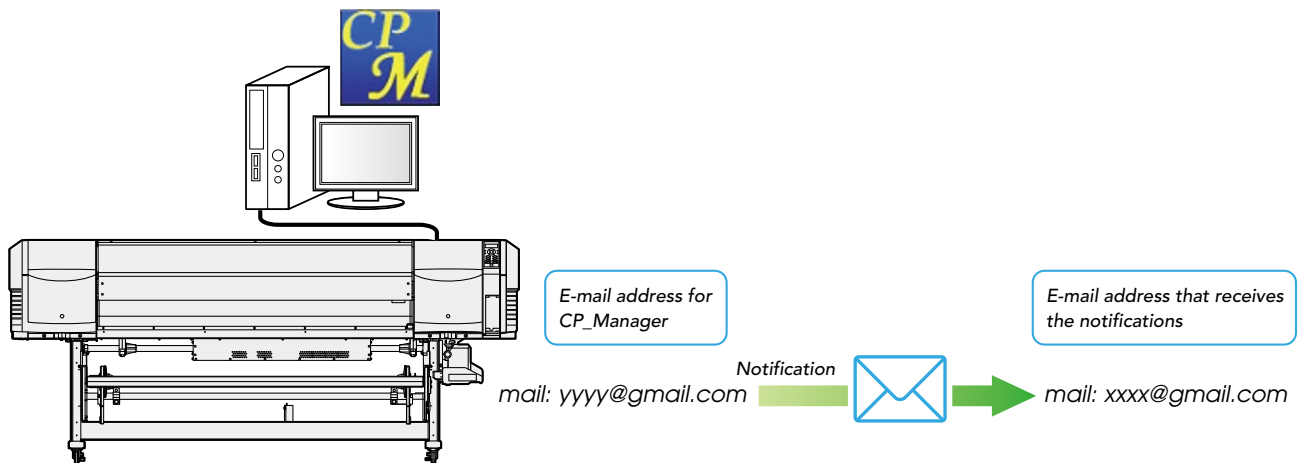

- * To use the e-mail function, the computer running CP_Manager must be connected to the Internet. You will not be able to use this function without a connection to the Internet or if the access to the e-mail server is restricted by a firewall on the network.
- * For CP_Manager, use one of the following types of e-mail address.
 - (1) A Google mail address
 - (2) An e-mail address on a server supporting SMTP.
 - The e-mail service provider must provide SMTP server information. Confirm with your e-mail service provider.
- * The notification function cannot be used when the computer running CP_Manager is sleeping or hibernating.

E-mail settings

To configure the settings, click the E-mail settings button (3) under Notification.

- (1) Set the e-mail account used by CP_Manager to send e-mails.
Normally use a Google mail account.
 - Google mail: Set the e-mail account information here.
Follow the steps (1) to (3) to configure the settings.
 - SMTP server: Set the SMTP server information when you use an e-mail service provider other than Google.
- (2) Enter the e-mail address that will receive the notifications.
Click the Send Test E-mail button to send a test e-mail to the specified address.

Settings

The following CP_Manager settings can be displayed and changed in this mode.

- CP_Manager language
- Printer nickname setting
- Date display

The following printer settings can be displayed and changed in this mode.

- Warning Sound Settings

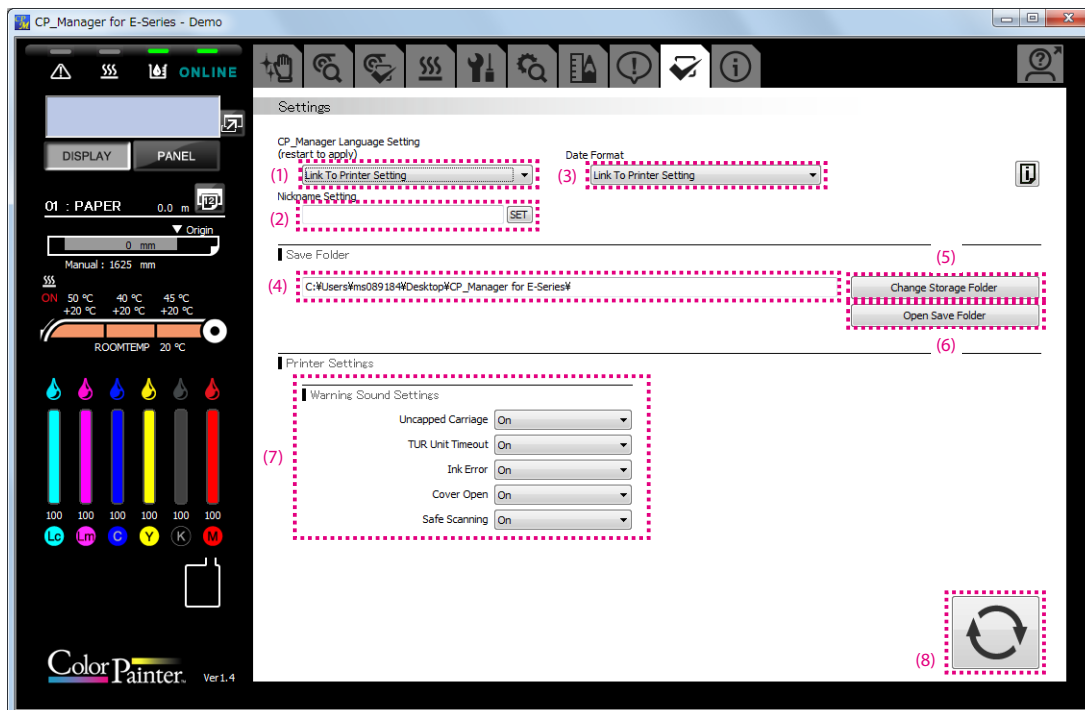

- | | |
|----------------------------------|---|
| (1) CP_Manager language setting: | Change the language displayed in CP_Manager. CP_Manager must be restarted to apply the setting. |
| (2) Nickname setting: | A different nickname can be set for each printer. |
| (3) Date display: | Set the display format for the date. |
| (4) Save folder path display: | Displays the paths of the media information and log information save folders. |
| (5) Change save folder button: | Click to change the media information and log information save folders. |
| (6) Open save folder buttons: | Click to open the media information and log information save folders. |
| (7) Warning sound settings: | Set the warning sounds of the printer. |
| (8) Update settings button: | Button used to send the warning sound settings to the printer and set the setting values. |

Printer information

The following operations can be performed in this mode.

- Display printer information
- Display ink cartridge information
- Display print head information
- Acquire log information

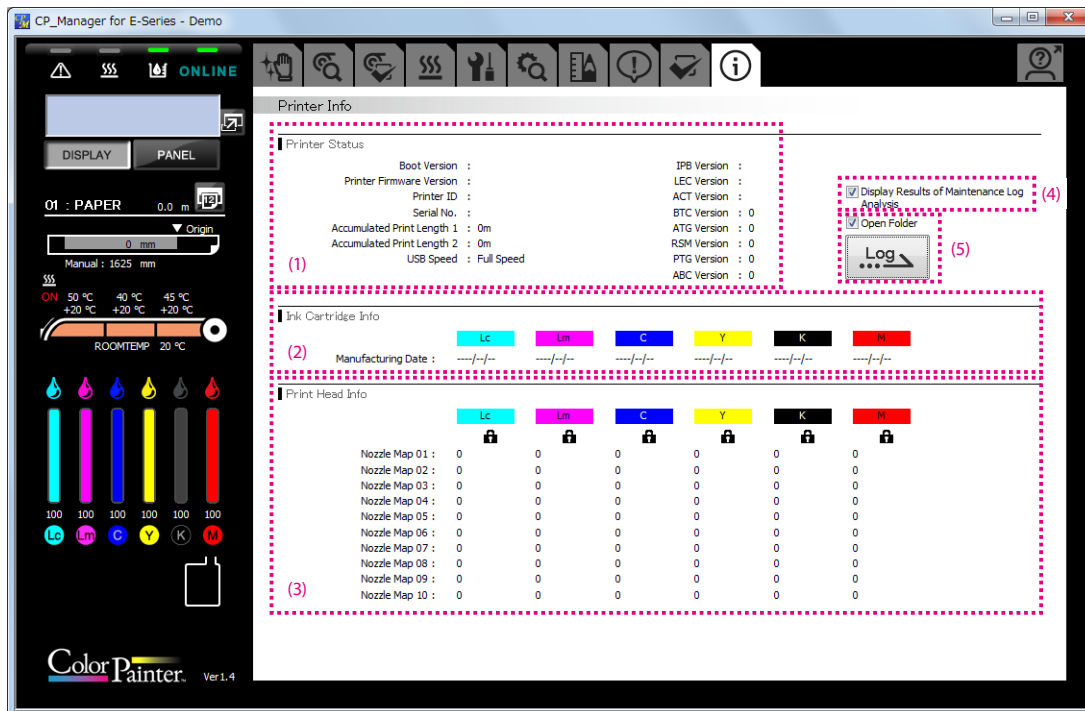

- | | |
|---|--|
| (1) Printer Status field: | Displays information such as firmware and hardware versions, and the accumulated print length. |
| (2) Ink Cartridge Info field: | Displays information related to the ink cartridges. |
| (3) Print Head Info field: | Displays information related to the print heads. |
| (4) Display Results of Maintenance Log Analysis checkbox: | Check the box to display the results of maintenance log analysis when log information is acquired. |
| (5) Acquire log information button: | Acquire printer log information.
Check the Open Folder box to open the folder where the log file is saved when log information is acquired. |

