

OKI

Wide Format Printer
Teriostar LP-2050 Series

LP-2050-MF

User's Manual for Multifunction Printer Operation

U00121379505



OKI Data Infotech Corporation

Chapter

1

Before Use

Chapter

2

Copy Function

Chapter

3

Submission
Function

Chapter

4

Preset Functions

Chapter

5

Scan Function

Chapter

6

Troubleshooting

U00121379500	August, 2010
U00121379501	January, 2011
U00121379502	July, 2011
U00121379503	July, 2013
U00121379504	April, 2015
U00121379505	December, 2015

Copyright© 2015 OKI Data Infotech Corporation.

All rights reserved.

The contents of this manual may be changed without prior notice.

This product displays fonts created by TypeBank Co., Ltd. and ARPHIC TECHNOLOGY.

This equipment has been tested and found to comply with the limits for a Class A digital device, pursuant to Part 15 of the FCC Rules. These limits are designed to provide reasonable protection against harmful interference when the equipment is operated in a commercial environment.

This equipment generates, uses, and can radiate radio frequency energy and, if not installed and used in accordance with the instruction manual, may cause harmful interference to radio communications. Operation of this equipment in a residential area is likely to cause harmful interference in which case the user will be required to correct the interference at his own expense.



The CE mark, that shows that the products sold in the EU are conformed to the requirements of EC directive, is statutorily obliged to be affixed to the products.

In each directive, the scope of directive to be applied to equipment is explicitly defined. Our company's product LP-2050 series conforms the EMC directive, low voltage directive and RoHS Directive.

Inquiry of CE mark:

OKI Europe Ltd.

Wide Format Division

Siemensstrasse 9 , D-63263 Neu-Isenburg

Germany

Tel: +49 (0)6102 297 400

Fax: +49 (0)6102 297 50 400

OKI Data Infotech Corporation

8 Nakase 1-chome, Mihama-ku, Chiba-shi, Chiba 261-8507, Japan

Phone : +81 43 211 1363

Fax : +81 43 211 8709

Preface

Your Printer is a Teriostar LP-2050 Series wide format Printer (Referred to as the Printer in this manual), and this manual describes how to operate the Printer's copy, submission, and scan functions.

For details about the print function, paper setting, consumable replacement, and paper jam clearance, see the separate ***User's Manual for Basic Printer Operation***.

To handle the Printer safely and correctly, be sure to read the ***Safety Precautions*** carefully before use.



Keep this manual in a place where you can easily read it when required.

Safety Precautions

In this manual, the following symbols are used to alert the user to information that will prevent damage to the Printer, and ensure its safe and correct use.

These symbols are explained below. Make sure that you thoroughly understand the information. Always follow the instructions marked by these symbols.

■ Symbol Examples

 Warning	If this information is ignored and the Printer is handled incorrectly, it may result in serious injury or death.
 Caution	If this information is ignored and the Printer is handled incorrectly, it may result in injury or machine damage.

△ This symbol indicates that caution is required (includes dangers and warnings).



The example on the left indicates a safety **Warning or Precaution**.



This symbol indicates a prohibited action.



The example on the left means **Do not disassemble**.



This symbol indicates required actions or instructions.



The example on the left means **Disconnect the power plug from the outlet**.



Warning



Be very careful not to touch the fuser unit labeled HIGH TEMPERATURE inside the Printer.
Burn injuries may result.



Do not disassemble or modify the Printer.
An accident or malfunction may result.



Do not heat a toner cartridge or a waste toner bottle containing waste toner, nor place it into a flame.
It may burst or ignite, resulting in an accident or fire.



Never use the Printer in a location exposed to abnormally high humidity or moisture.
A fire, electric shock, or malfunction may result.



Do not drop metal pieces such as staples, or spill water, or other liquids inside the Printer or through gaps.
A fire, electric shock, or malfunction may result.



Do not connect or disconnect the power cord or other parts with wet hands. An electric shock may result.



In the following situations, turn off the power, and disconnect the power plug from the outlet. If you continue using the Printer in an abnormal condition, an accident or fire may result.

- ◇ When cleaning
- ◇ When an abnormal odor, noise, or smoke is emitted
- ◇ When foreign matter such as metal pieces or water get inside the Printer or through gaps
- ◇ When a problem that must be repaired by the service representative occurs



Connect the power plug separately to a power socket with a rated voltage of 120V and a rated current of 16A or more, or to a power socket with a rated voltage of 230V and a rated current of 9A or more. To prevent a fire or electric shock, avoid the sharing of power with other equipment.



Be sure to remove the dust on the power plug and the socket. Do not use a dusty plug as a current leak due to humidity on its surface may heat the plug and result in fire.



Do not fix, twist, bind, modify, stretch, or bend excessively the power cord. Do not put heavy object on it. A damaged power cord may heat and result in fire or electrical shock.



If the power cord is cut or if the wires are exposed, ask a service representative for replacement.
Using a damaged power cord may result in fire or electrical shock.



Caution



Do not disassemble or modify the toner cartridge.
The toner on your skin will have a negative effect.
If ink stains your skin or clothing, wash with soap and water immediately.



To prevent a toner leakage, do not drop the toner cartridge nor expose it to strong impacts.
If toner gets into your eyes, do not rub your eyes, and wash the toner out. Visit a doctor immediately.



As the roll paper is heavy, handle it carefully to make sure that you do not drop it.
Dropping the roll paper on your feet may result in injury.



When installing the roll paper, use the cutter to cut the end of the paper. At this time, be careful not to injure yourself on the cutter.



Install the Printer close to a power outlet. Make sure the outlet is easy to reach in case the power plug needs to be disconnected in an emergency.



When connecting and disconnecting the power cord, hold it by the plug or connector.
To prevent a fire, electric shock, or malfunction, avoid pulling the cord.



If you use a power strip, change it for a new one at least once a year.



Do not use an extension cable or an adapter plug.



Once a month, turn the power switch off and inspect the followings. Contact your service representative if you detect any problem.

- ◇ The plastic insulator at the base of the plug's pins does not suffer from heat deformation.
- ◇ The plug's pins are not bent or covered by rust.
- ◇ There is no dust between the plug's pins.
- ◇ The power cord is not frayed and the energized wires are not exposed.
- ◇ The plug is firmly plugged into the socket.
- ◇ There is no dust on the plug or the socket.



Before moving the Printer from its current installation location to another location, contact your service representative.

In addition to the items above, observe the warnings and precautions in each section of the manual.

Reading the Manual

◆ Notations

■ Indicators

Warning

- ◆ Describes information equivalent to a **Warning** in a safety precaution.

Caution

- ◆ Describes information equivalent to a **Caution** in a safety precaution.

Note

- ◆ Describes the information to be noted on handling the Printer.



TIP

The **Tip** indicator.

Indicates useful information, supplementary operation, or other information.

 **page** The **Reference** indicator.

The reference section or page is shown after this indicator.

Table of Contents

Preface

Chapter **1** Before Use

▼ Copy Restrictions	14
▼ About the Multiple Functions	15
Print Function	15
Copy Function.....	15
Submission Function.....	15
Scan Function.....	15
▼ Main Functions	16
▼ About Originals	19
Scannable Original Conditions.....	19
Unscannable Originals.....	19
Using Carrier Sheets with Originals	20
Guaranteed Image Scan Range.....	21
▼ Loading the Original	22
Loading the Original.....	22
Canceling Original Scanning	24
▼ Regular Cleaning	26
Cleaning the Shading Guide and Scanner Glass.....	26

Chapter 2

Copy Functions

▼ Copy Operation Flow.....	28
▼ Copy Function Overview	30
▼ Selecting the Original Type.....	31
▼ Adjusting the Density.....	32
▼ Selecting the Paper Position.....	33
▼ Selecting the Original Size	34
▼ Selecting the Original Size Standard.....	38
▼ Selecting the Original Output Direction	39
▼ Partial Copying	40
▼ Adjusting the Background	42
▼ Adjusting the Original's Contrast.....	43
▼ Adjusting the Original's Sharpness.....	44
▼ Performing White on Black Reverse	45
▼ Setting the Scale.....	46
▼ Adding Blank Space.....	47
▼ Selecting the Paper Type	48
▼ Centering scan image.....	49
▼ Erasing the Frame	50
▼ Selecting the Paper Output Slot	51
▼ Performing Mirror Reverse.....	52
▼ Entering the Number of Copies.....	53
▼ Performing a Moderate Scan	54
▼ Copying an Original with Text & Lines	55
▼ Copying a Blueprint Original	56
▼ Sorting.....	57
▼ Sorting Flow	58
▼ Test Printing Sorted Originals.....	61
▼ Additionally Copying the Sorted and Printed Originals.....	62
▼ Initializing the Setting.....	63
▼ Handling copy jobs	64
▼ Additionally copying the Copied Originals.....	65

Chapter 3

Submission Functions

- ▼ **Submission Functions Outline.....68**
- ▼ **Preparing the network and host computer70**
 - Checking the Printer's Network Connection..... 70
 - Creating a Shared Folder..... 70
 - Preparing a printer to receive submissions 71
- ▼ **Submission Operation Flow72**
 - Submitting images (SMB connection)..... 72
 - Submitting images (FTP connection)..... 75
 - Storing image data in the submission job box 78
 - Submitting thumbnails..... 80
 - Submitting to a printer 82
- ▼ **Submission Function Overview..... 84**
- ▼ **Selecting Scan Color Mode85**
- ▼ **Selecting Original Type86**
- ▼ **Selecting Scan Resolution87**
- ▼ **Selecting the File Format for Images to be Scanned88**
- ▼ **Configuring the Filename for Images to be Scanned90**
- ▼ **Submission and Copy in One Operation92**
- ▼ **Print Copies93**
- ▼ **Print Quality94**
- ▼ **Handling Image Submission Jobs.....95**
- ▼ **Handling Printer Submission Jobs.....96**
- ▼ **Reprinting through Printer Submission97**

Chapter 4

Preset Functions

- ▼ Presets Overview..... 100
- ▼ Creating a preset in the Memory101
- ▼ Calling a Preset from the Memory102
- ▼ Saving Settings as Default Settings.....103
- ▼ Changing a Preset Name 104
- ▼ Creating a Preset in the Memory for a Submission Destination 105

Chapter 5

Scan Functions

- ▼ Scan Functions Outline 108
- ▼ Preparing the network and host computer 109
 - Checking the Printer's Network Connection..... 109
 - Installing the Exclusive Application (TerioStation)..... 109
 - Configuring the Exclusive Application (TerioStation)..... 109
- ▼ Checking Operating Status with Message 110

Chapter 6

Troubleshooting

- ▼ Unclear Copying or Scanning 115
- ▼ Cannot Copy or Scan as Expected 118
- ▼ Improper Submission 122

Chapter 1

Before Use

Chapter 1 describes the information required for operating the Printer. Be sure to understand the basic information described in this chapter before moving to the next chapters.

Chapter Contents

- ▼ Copy Restrictions 14
- ▼ About the Multiple Functions..... 15
- ▼ Main Functions 16
- ▼ About Originals 19
- ▼ Loading the Original.....22
- ▼ Regular Cleaning26

Copy Restrictions

Depending on the subject matter, copying may be restricted or prohibited by law.

<Items restricted by law>

- Government-issued banknotes, coins, securities, government bonds, local government bonds (including items marked as samples)
- Banknotes, coins, or securities in circulation in other countries
- Unused postage stamps or postcards without government copying permission from the government
- Government-issued payment stamps, or securities restricted by law
- Other items prohibited by related laws

<Items treated with discretion>

- Privately-issued securities (such as stocks, bills, checks), commuter tickets. Other than the minimum copying required for companies to use in their operations, the government advises caution.
- Also, it is better to think items such as government-issued passports, licenses issued by public or private bodies, permits, ID cards, traffic tickets, and food tickets should not be copied.

<Copyrighted items>

- The copying of copyrighted items such as novels, music, paintings, prints, maps, drawings, movies, and photographs is prohibited except for personal or household use, or within a scope based on such use.

About the Multiple Functions

The Printer is equipped with print, copy, submission, and scan functions. Select a function by pressing the corresponding button.

◆ Print Function

Prints after receiving data created on a workstation, or personal computer (referred to as computer in this manual).

For more details, see the separate *User's Manual for Basic Printer Operation*.

◆ Copy Function

Copies in accordance with the type and image quality of the original.

For more details, see [Chapter 2](#).

◆ Submission Function

Submits image data scanned with the Printer to the computer's shared folder.

For more details, see [Chapter 3](#).

◆ Scan Function

Sends image data scanned with the Printer to the computer connected to the network using the exclusive application.

For more details, see [Chapter 5](#).

Main Functions

Chapter
1

This section describes the main functions for copying and submission.

Before Use

Chapter
2

Copying/submitting after selecting the appropriate original type (📖 page 31 and 📖 page 86)

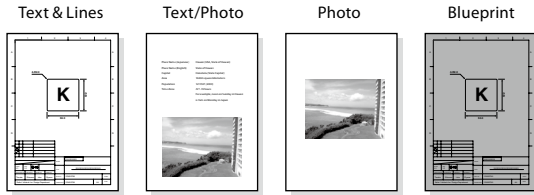

Copy Function

Chapter
3

Copying/submitting after deleting background color from the original (📖 page 42)

Original with Background Color

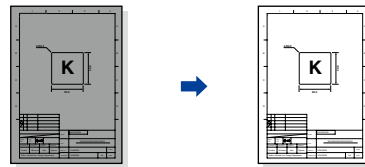

Submission Function

Chapter
4

Copying/submitting after adjusting the density (📖 page 32)

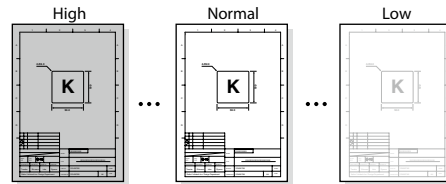

Preset Functions

Chapter
5

Copying after scaling (📖 page 46)

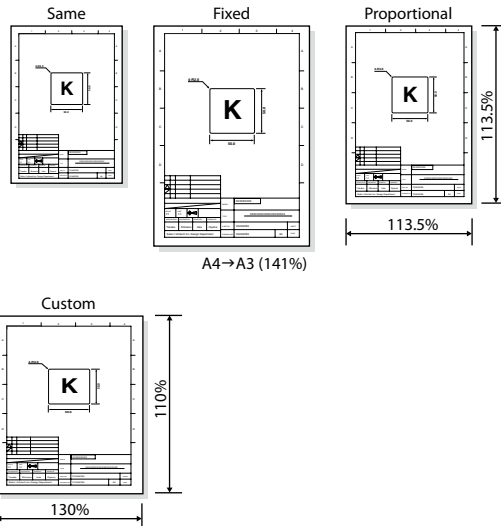

Scan Function

Chapter
6

Troubleshooting

Copying after adding blank space to the top and bottom of the original
(📖 page 47)

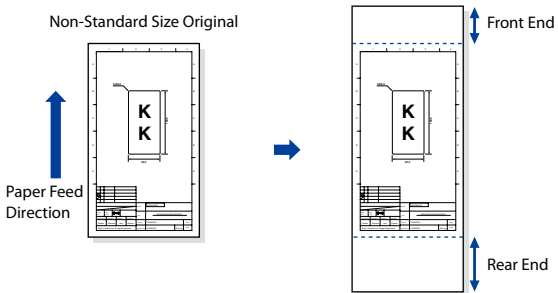

Copying the original partially
(📖 page 40)

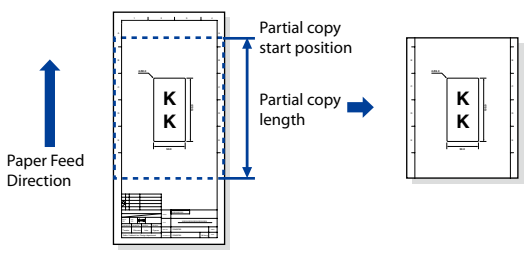

Copying after deleting the frame
(📖 page 50)

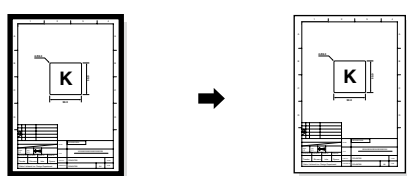

Copying/submitting after adjusting the original's contrast
(📖 page 43)

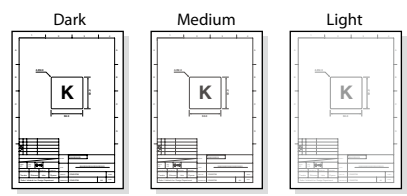

Copying after performing mirror reverse for the original
(📖 page 52)

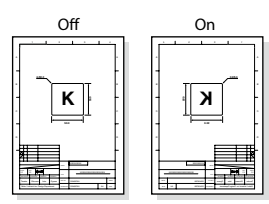

Copying/submitting after performing white on black reverse for the original
(📖 page 45)

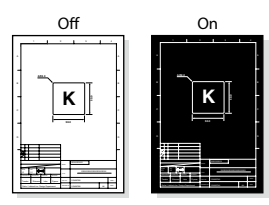

Copying after sorting multiple originals
 (📖 page 57)

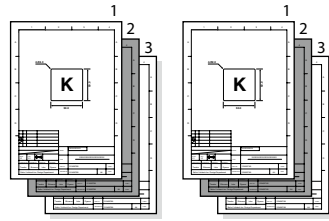

Copying/submitting after adjusting the original's sharpness
 (📖 page 44)

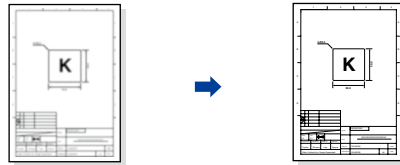

Submitting after selecting the scan resolution
 (📖 page 87)

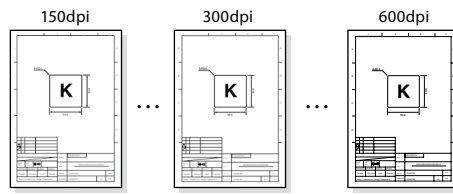

Submitting after selecting the file format of the scan data.
 (📖 page 88)

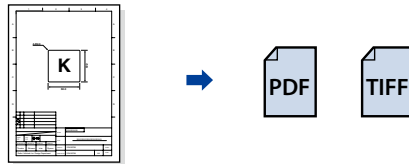

About Originals

This section describes the original sizes and thicknesses available with the Printer. It also describes the scannable range.

◆ Scannable Original Conditions

Maximum width: 914.4 mm (36 inches)

Minimum width: 182 mm (7.17 inches)

Maximum length: 10000 mm (393.70 inches)

Minimum length: 210 mm (8.27 inches)

Thickness: 0.05 (0.002 inches) to 0.2 mm (0.008 inches)

Type: Non-transparent or semi-transparent originals

Other conditions:

- Originals with no folds, wrinkles, tears, or holes
- When the original is rolled, the diameter must be at least 40 mm (1.57 inches)
- When the original is rolled, extend it to make the curl width 80 mm (3.14 inches) more, and the height 10 mm (0.39 inches) or less as follows.



◆ Unscannable Originals

The following originals may cause paper jams, or they may be damaged.

- Originals non included in those described in **Scannable Original Conditions** (📖 page 19)
- Originals with staples or clips
- Originals with tears, fissures, or holes
- Originals with wrinkles, rips, or other defects
- Originals with curls or waves
- Originals with folds
- Originals with 2 or more sheets affixed or overlapped together
- Originals with processed surfaces. For example, thermal paper, art paper, foil, carbon paper, or conductive paper

- Originals with protruding parts such as an index or label
- Originals that are thin and soft
- Originals that are bound (such as books)
- Originals that are wet or sticky
- Originals with partial thickness differences
- Originals stuck with adhesive tape or glue
- Originals with a thick plate attached to the end
- Originals with undried ink or correction fluid
- Originals with rear carbon attached
- Originals other than paper (such as electronic substrates, glass products, or metal products)

◆ Using Carrier Sheets with Originals

Note

- ◆ **Be sure to use a carrier sheet to protect important or glossy originals.**
 - * **Without the carrier sheet, the original may be damaged by a jam or similar problem.**

The tracks from the advance roller may mark the original.

Use a carrier sheet for the following original types.

- Originals with 2 or more sheets affixed or overlapped together
- Originals with folds
- Originals with wrinkles, rips, or other defects
- Originals with curls or waves
- Originals with tears, fissures, or holes
- Originals with a trace of paper clip
- Originals with staples
- Originals stuck with adhesive tape or glue
- Originals not straight on the front end
- Originals such as photographs that stick easily to glass
- Originals such as pencil drawings that may make the scanner glass or other parts dirty

Also, to scan a non-standard size as a standard size, use a carrier sheet.

◆ Guaranteed Image Scan Range

The Printer scans all the original except for 5 mm (0.20 inches) to the front and rear, and 3 mm (0.12 inches) on both sides.

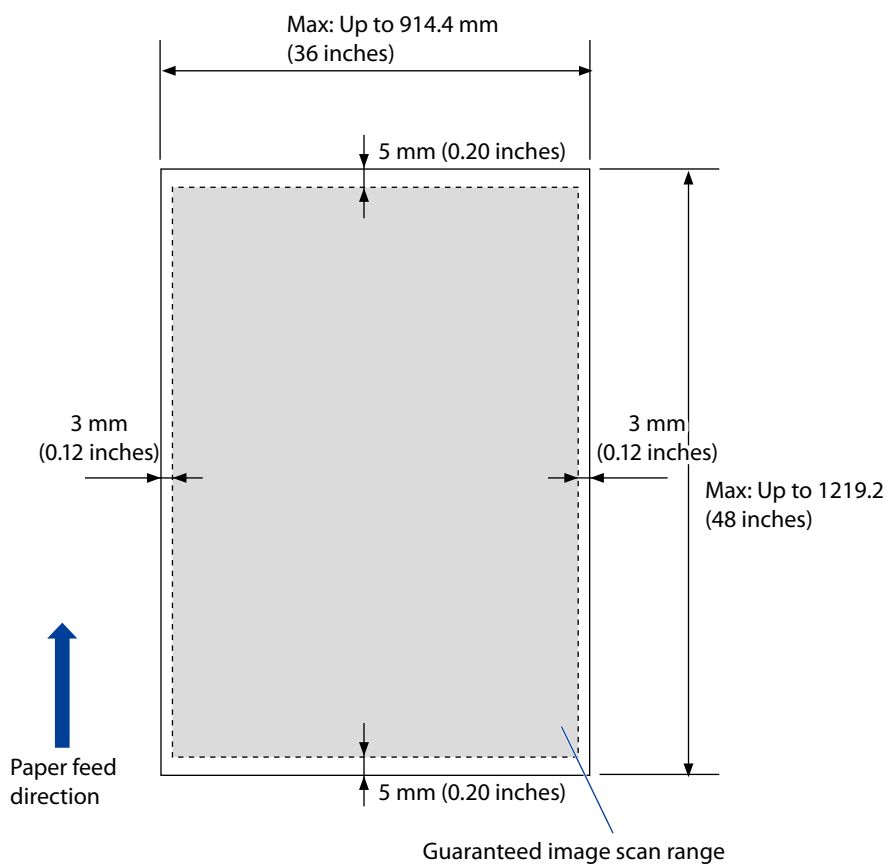

Loading the Original

This section describes how to load the original.

◆ Loading the Original

1

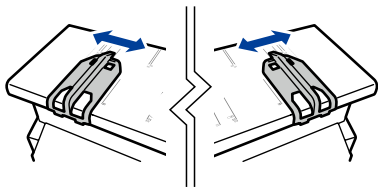

Adjust the position of the original width guide.

Slide the right and left original width guides so that they are aligned with the size line appropriate for the original size.



TIP ◆ Alignment area differs depending on the size standard as follows.

Align the right original width guide for A series originals

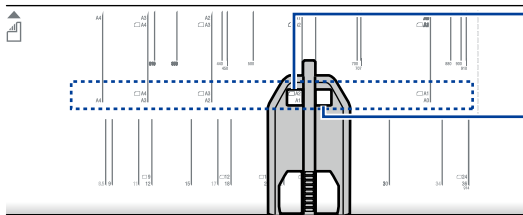

Slide the guide so that the desired A series size is shown in this window.

For the left original width guide: Slide the guide so that the desired A series size is shown in this window.

Align the right original width guide for originals with size standards in mm

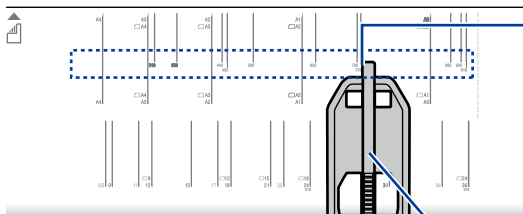

For the right original width guide: Align the center bar's left edge with the size line.

For the left original width guide: Align the center bar's right edge with the size line.

Center bar

Align the right original width guide for originals with size standards in inch, and with 610 mm (24.02 inches) and 914 mm (35.98 inches)

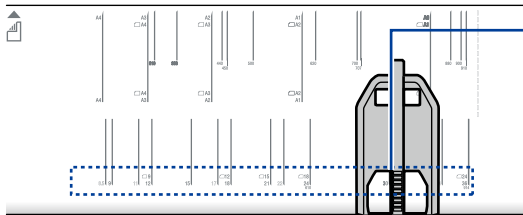

For the right original width guide: Align the center bar's left edge with the size line.

For the left original width guide: Align the center bar's right edge with the size line.

2

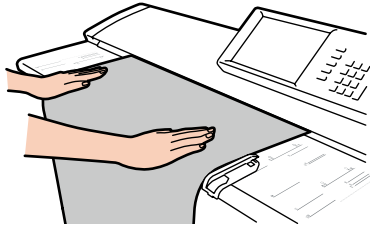

Load the original.

Position the original facing down. Set it in the Printer aligned with the original width guide. The inserted original is automatically pulled into the Printer, and set.



TIP

- ◇ Position the original touching the front roller, and keep it slack. This ensures the original is inserted straight.
- ◇ When scanning a long original, roll the original in your hands, and then set it. This makes it easier to scan the original straight.

Note

- ◇ The Printer can output the original either to the front or the rear. When outputting from the front, to prevent the original from being damaged, keep the original width guide out of the way at both ends.
- ◇ In this Printer, the original is set in the center. Even when the original is not a standard size, set it in the middle.
- ◇ When the Printer is set to output the original from the front, set the original by aligning it with a size line.
- ◇ When using a carrier sheet, do not set the Printer to output the original from the front. The carrier may catch, resulting in damage to the original.

◆ Canceling Original Scanning

To cancel the scanning of the original partway, for example, if the original is fed at an angle, or is ripped, perform the steps below.

1

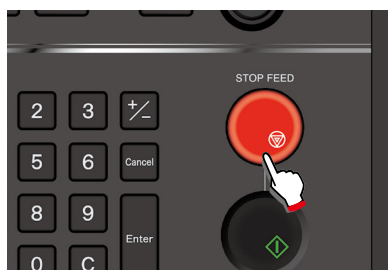

Press STOP FEED.

When **STOP FEED** on the operation panel is pressed, the scanning stops partway.

2

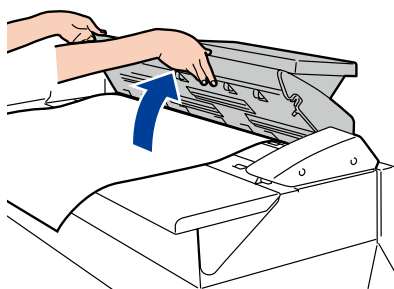

Open the scanner cover.

3

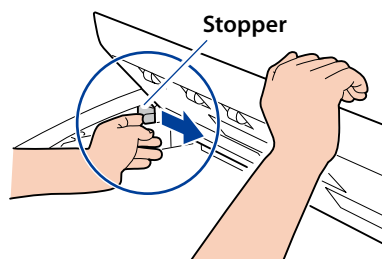

Lock the stopper by sliding it to the right.

Slide the stopper to the right.

4

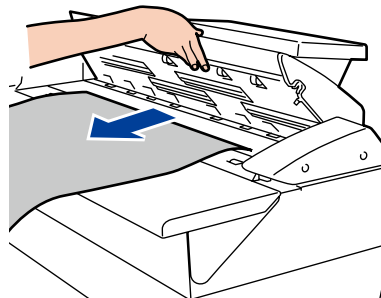

Remove the original.

Open the scanner cover, and remove the original.

5

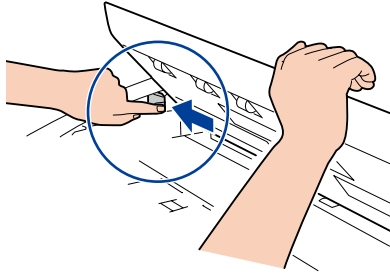

Release the stopper by sliding it to the left side.

Slide the stopper to the left.

6

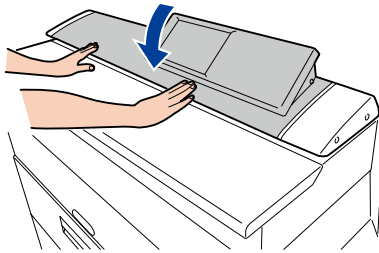

Close the scanner cover.

Then the Printer becomes ready.

Regular Cleaning

Chapter
1

Before Use

Dirt from originals and other foreign matter may adhere to the original scanning area. Clean this area regularly.

Chapter
2

Copy Function

Note

- ◆ Never use volatile solvents such as thinner, benzene, or alcohol.

Chapter
3

Submission Function

◆ Cleaning the Shading Guide and Scanner Glass

Set the stopper before cleaning the original scanning area.

Wipe the shading guide and scanner glass with a dry cloth.

If they are significantly dirty, soak a soft cloth in water or a neutral detergent diluted with water, wring the cloth thoroughly, and then wipe them.

Chapter
4

Preset Functions

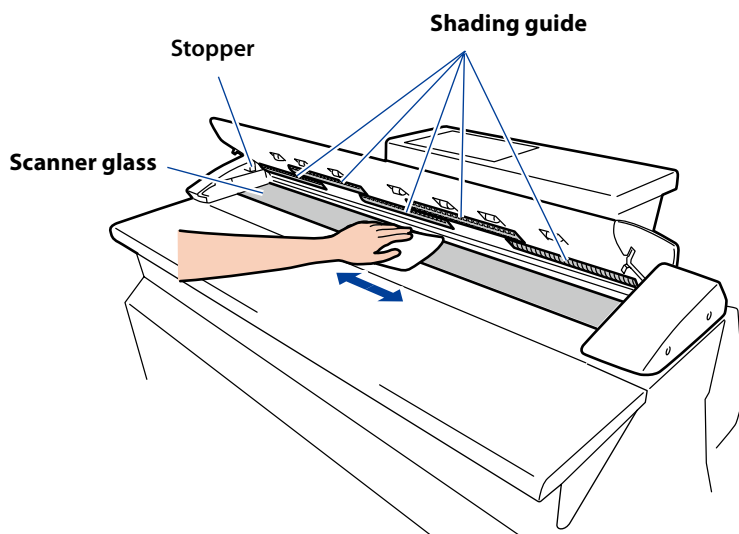

Chapter
5

Scan Function

Chapter
6

Troubleshooting

Chapter 2

Copy Functions

This chapter describes the copy functions of the Printer.

Chapter Contents

▼ Copy Operation Flow.....	28
▼ Copy Function Overview	30
▼ Selecting the Original Type.....	31
▼ Adjusting the Density	32
▼ Selecting the Paper Position.....	33
▼ Selecting the Original Size	34
▼ Selecting the Original Size Standard	38
▼ Selecting the Original Output Direction	39
▼ Partial Copying	40
▼ Adjusting the Background	42
▼ Adjusting the Original's Contrast.....	43
▼ Adjusting the Original's Sharpness	44
▼ Performing White on Black Reverse	45
▼ Setting the Scale	46
▼ Adding Blank Space.....	47
▼ Selecting the Paper Type.....	48
▼ Centering scan image.....	49
▼ Erasing the Frame	50
▼ Selecting the Paper Output Slot	51
▼ Performing Mirror Reverse.....	52
▼ Entering the Number of Copies.....	53
▼ Performing a Moderate Scan	54
▼ Copying an Original with Text & Lines.....	55
▼ Copying a Blueprint Original	56
▼ Sorting.....	57
▼ Sorting Flow	58
▼ Test Printing Sorted Originals.....	61
▼ Additionally Copying the Sorted and Printed Originals	62
▼ Initializing the Setting.....	63
▼ Handling copy jobs	64
▼ Additionally copying the Copied Originals.....	65

Copy Operation Flow

This section describes the basic operation flow for copying an original.



When authentication is necessary, enter a username and password, or PIN code.
For more details, see [Chapter 4](#) in the separate *User's Manual for Basic Printer Operation*.



Copy's top screen

Select the Original Type

Select the image quality type of the original. (page 31)

Select the Paper Position

From the paper types installed in the Printer, select the paper type for copying. (page 33)

Adjust the Density

Adjust the copy density. (page 32)

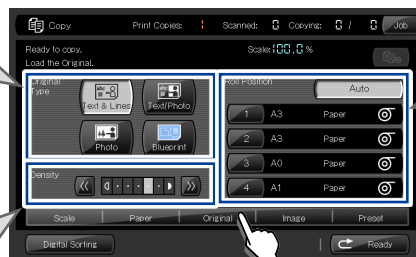

Press Original



Original Settings screen

Select the Original Size

Select the size of the original. (page 34)
With the default setting AUTO, the Printer automatically selects the paper size.



Press Scale



Scaling screen

Setting the Scale

Set to enlarge or reduce the original's size. (📖 page 46)

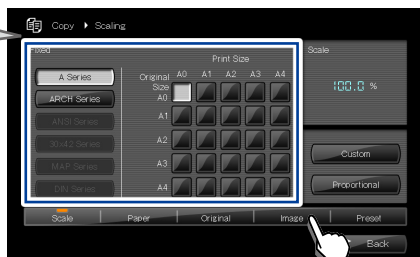

Press Image

Image Quality screen

Adjust the Background

Adjust the background color for originals with an uneven density. (📖 page 42)

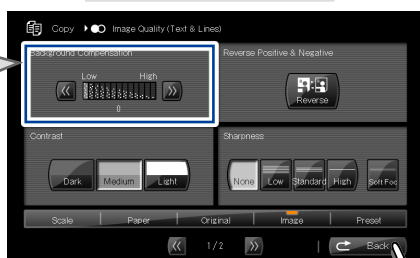

Press Back

Enter the Number of Copies

Enter the desired number of copies.

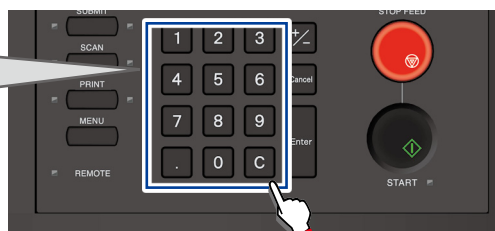

Load the original

Load the original into the Printer. (📖 page 22)

Press START

When **Start Scanning** is set to **Original Setting** in the System menu, copying and submission start automatically even if START is not pressed.

For more details, see **Chapter 3** in the separate **User's Manual for Basic Printer Operation**.



Copy Function Overview

The copy functions available with the Printer are as follows. The detailed setting procedures are described from the next page.

Function	Description
Original Type	Select an image quality type appropriate for the original.
Copy Density	Adjust the copy density.
Paper Position	From the paper types installed in the Printer, select the paper type for copying.
Original Size	Specify the size of the original.
Original Size Standard	Select the original size standard.
Original Output Direction	Set the output direction for the original.
Partial Copy	Copy an original partially.
Background Compensation	Delete background colors.
Contrast	Adjust the contrast of the original.
Sharpness	Adjust the sharpness of the original's contours.
White on Black Reverse	Copy an original with its white and black reversed.
Scale	Scale the size of the original.
Blank Space	Set blank space to the front and rear of the original.
Paper Type	From the paper types installed in the Printer, select the paper type for copying.
Centering	Copy the image at the center of the paper width. This function is effective at Synchro Scan with the roll paper position specified.
Erase Frame	Erase the area around the original before copying.
Output Slot Selection	Select the output slot for the paper.
Mirror Reverse	Perform mirror reverse for the original before copying.
Number of Copies	Set the number of copies.
Moderate Scan	Feed the original moderately on scanning to prevent the original from being damaged.
Original with text & lines	Adjust the image quality appropriate for the originals with text and lines.
Blueprint Original	Set the image quality appropriate for the blueprint original.
Sort	Sort multiple originals before copying.

Selecting the Original Type

Select an image quality type appropriate for the original. This setting improves the image quality of the printout.

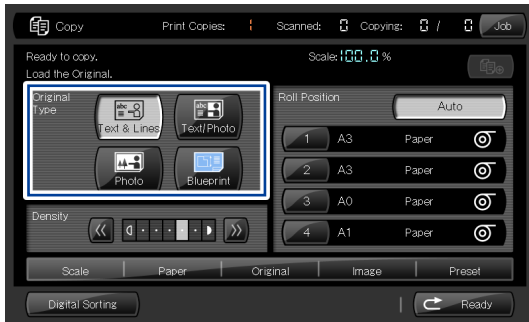

■ Text & Lines

Select for originals with mixed text and line art.

■ Text/Photo

Select for originals with mixed text and photos.

■ Photo

Select for general photos.

■ Blueprint

Select for blueprint originals.

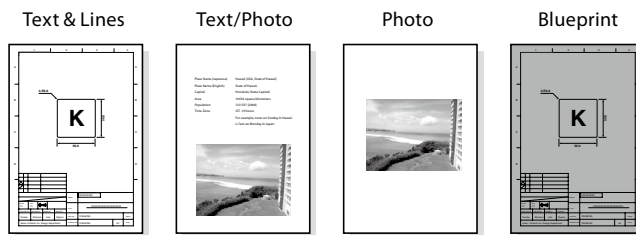

TIP

◇ For a blueprint original,

- Select **Blueprint** here; and
- Adjust the image quality parameters, as described in **Copying a Blueprint Original** (📖 page 56).

Adjusting the Density

Chapter
1

Before Use

Chapter
2

Copy Function

Chapter
3

Submission Function

Chapter
4

Preset Functions

Chapter
5

Scan Function

Chapter
6

Troubleshooting

Adjust the density when copying an original. Select the desired density, to suit the density of the original.

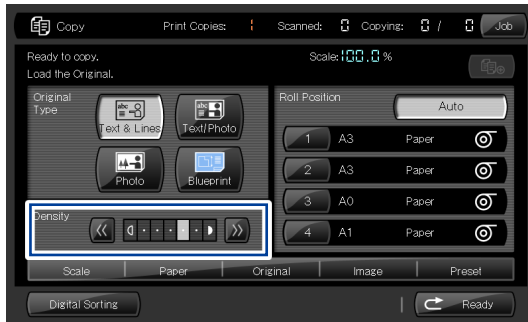

Density can be adjusted in seven levels.

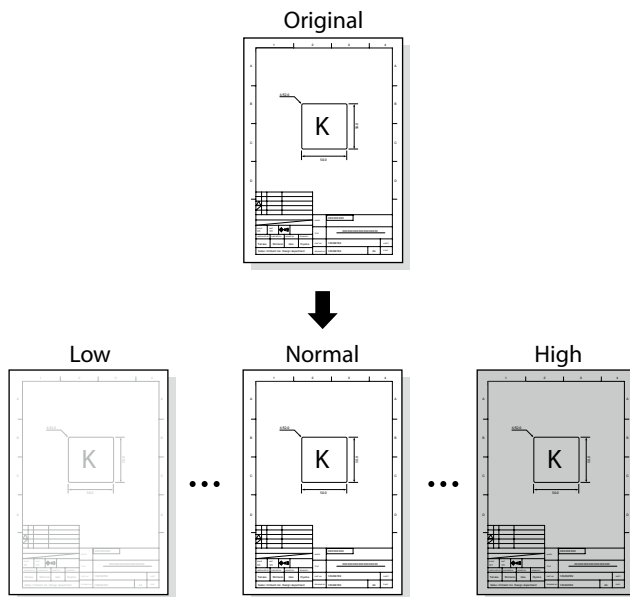

Selecting the Paper Position

From the paper types installed in the Printer, select the paper type for copying.

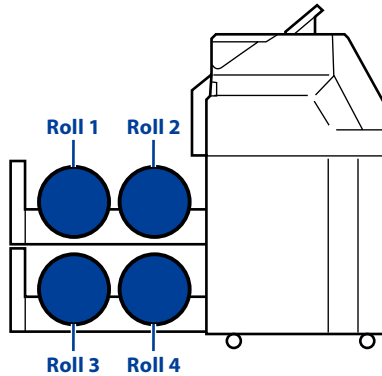

When Auto is selected, The Printer automatically selects the printing paper suitable for the original.

Selecting the Original Size

Select the size of the original.

The following four settings are available for the original size.



■ Auto

With Auto selected, the Printer identifies the original to be:

- A standard portrait or landscape size; or
- A non-standard size.

Note: In the submission mode, Auto cannot be selected.

■ Portrait

Select for standard size originals and vertically oriented.

■ Landscape

Select for standard size originals and horizontally oriented.

■ Synchro Scan

Select for non-standard size originals. When Synchro Scan is selected, the paper is cut to the same length as the original, which is called as synchro cut.

Note

- ◆ When the original size is set to **Auto**, the **Adding Blank Spase** (📖 page 47), and **Erasing the Frame** (📖 page 50) settings are disabled.
- ◆ When **Selecting the Original Size Standard** (📖 page 38) is set to **User Defined**, all settings are handled as **Synchro Scan**, even when **Portrait** or **Landscape** is set to **On**.

The paper sizes available for the Printer are as follows.

A Series Standard Size Originals

Original	Longer Side	Shorter Side	Load Direction
A0	1189 mm (46.81 inches)	841 mm (33.11 inches)	Landscape
A1	841 mm (33.11 inches)	594.5 mm (23.41 inches)	Landscape or portrait
A2	594.5 mm (23.41 inches)	420.5 mm (16.56 inches)	Landscape or portrait
A3	420.5 mm (16.56 inches)	297.3 mm (11.70 inches)	Landscape or portrait
A4	297.3 mm (11.70 inches)	210.3 mm (8.28 inches)	Landscape or portrait

A Series Width Originals

Original	Paper Width	Minimum Original Length	Maximum Original Length
A0 width	841 mm (33.11 inches)	210 mm (8.27 inches)	10000 mm (393.70 inches)
A1 width	594.5 mm (23.41 inches)		
A2 width	420.5 mm (16.56 inches)		
A3 width	297.3 mm (11.70 inches)		
A4 width	210.3 mm (8.28 inches)		

ARCH Series Standard Size Originals

Original	Longer Side	Shorter Side	Load Direction
E	1219.2 mm (48 inches)	914.4 mm (36 inches)	Landscape
D	914.4 mm (36 inches)	609.6 mm (24 inches)	Landscape or portrait
C	609.6 mm (24 inches)	457.2 mm (18 inches)	Landscape or portrait
B	457.2 mm (18 inches)	304.8 mm (12 inches)	Landscape or portrait
A	304.8 mm (12 inches)	228.6 mm (9 inches)	Landscape or portrait

ARCH Series Width Originals

Original	Paper Width	Minimum Original Length	Maximum Original Length
E width	914.4 mm (36 inches)	210 mm (8.27 inches)	15000 mm (590.55 inches)
D width	609.6 mm (24 inches)		
C width	457.2 mm (18 inches)		
B width	304.8 mm (12 inches)		
A width	228.6 mm (9 inches)		

ANSI Series Standard Size Originals

Original	Longer Side	Shorter Side	Load Direction
E	1117.6 mm (44 inches)	863.6 mm (34 inches)	Landscape
D	863.6 mm (34 inches)	558.8 mm (22 inches)	Landscape or portrait
C	558.8 mm (22 inches)	431.8 mm (17 inches)	Landscape or portrait
B	431.8 mm (17 inches)	279.4 mm (11 inches)	Landscape or portrait
A	279.4 mm (11 inches)	215.9 mm (8.5 inches)	Landscape or portrait

ANSI Series Width Originals

Original	Paper Width	Minimum Original Length	Maximum Original Length
E width	863.6 mm (34 inches)	210 mm (8.27 inches)	15000 mm (590.55 inches)
D width	558.8 mm (22 inches)		
C width	431.8 mm (17 inches)		
B width	279.4 mm (11 inches)		
A width	215.9 mm (8.5 inches)		

30×42 Series Standard Size Originals

Original	Longer Side	Shorter Side	Load Direction
30×42	1066.8 mm (42 inches)	762.0 mm (30 inches)	Landscape
15×21	533.4 mm (21 inches)	381.0 mm (15 inches)	Landscape or portrait

30x42 Series Width Originals

Original	Paper Width	Minimum Original Length	Maximum Original Length
30"	762.0 mm (30 inches)	210 mm (8.27 inches)	15000 mm (590.55 inches)
21"	533.4 mm (21 inches)	210 mm (8.27 inches)	15000 mm (590.55 inches)
15"	381.0 mm (15 inches)	210 mm (8.27 inches)	15000 mm (590.55 inches)

MAP Series Standard Size Originals

Original	Longer Side	Shorter Side	Load Direction
B1	1000.0 mm (39.37 inches)	700.0 mm (27.56 inches)	Landscape
B2	700.0 mm (27.56 inches)	500.0 mm (39.37 inches)	Landscape or portrait

MAP Series Width Originals

Original	Paper Width	Minimum Original Length	Maximum Original Length
B1 width	700.0 mm (27.56 inches)	210 mm (8.27 inches)	15000 mm (590.55 inches)
B2 width	500.0 mm (39.37 inches)		

DIN Series Standard Size Originals

Original	Longer Side	Shorter Side	Load Direction
B1	1000.0 mm (39.37 inches)	707.0 mm (27.83 inches)	Landscape
B2	707.0 mm (27.83 inches)	500.0 mm (39.37 inches)	Landscape or portrait
B3	500.0 mm (39.37 inches)	353.0 mm (13.90 inches)	Landscape or portrait

DIN Series Width Originals

Original	Paper Width	Minimum Original Length	Maximum Original Length
B1 width	707.0 mm (27.83 inches)	210 mm (8.27 inches)	15000 mm (590.55 inches)
B2 width	500.0 mm (39.37 inches)		
B3 width	353.0 mm (13.90 inches)		

Selecting the Original Size Standard

Select the size standard applied to the original.



Note

- ◆ This menu shows only size standards with Available Size Standards set to On in the System menu. (For more details, see the separate *User's Manual for Basic Printer Operation*.)
- ◆ Make sure this setting matches the original to be loaded.
- ◆ To load a user defined series original, specify the size at User Defined Size in the System menu. (For more details, see the separate *User's Manual for Basic Printer Operation*.)
- ◆ With Original Size Setting set to Auto, the Printer automatically identifies the originals of several size standards. However, the scan operation time is slightly longer, as the Printer prescans the edge of the original to identify its width. When you intend to print on the paper of only one size standard, you are recommended to set Original Size Setting to that size standard. For example, when you print only on A series paper, you are recommended to set Original Size Setting to A Series, so that the scan operation time is reduced.

Selecting the Original Output Direction

In this Printer, either front or rear output is available for the original. Select on this screen the output direction for the original.



Note

- ◆ Output from the front is limited to originals up to 1219.2 mm (48 inches) in length.
- ◆ The Printer can output the original either to the front or the rear. When outputting from the front, to prevent the original from being damaged, keep the original width guide out of the way at both ends.

Partial Copying

With this function, the Printer copies an original partially.

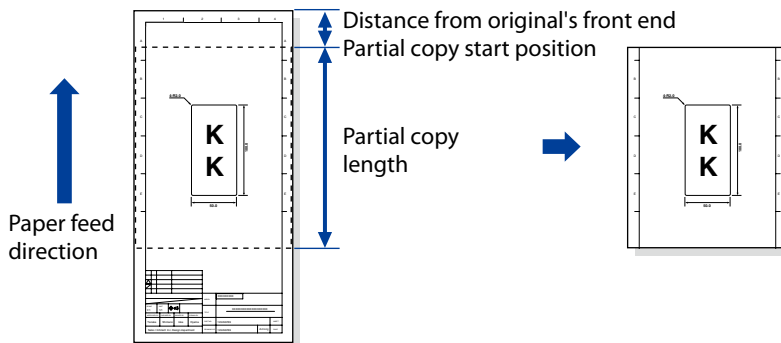
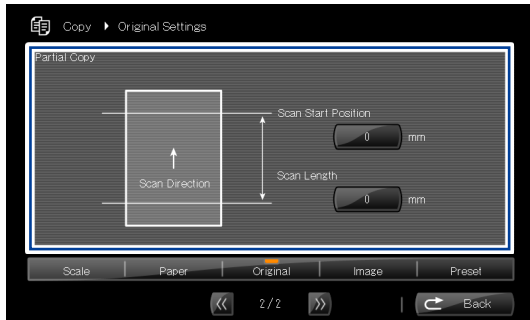

- TIP**
- ◇ You may need many test copies to check the optimal density and image quality for an original. In such cases, this function is useful for copying only a part of the original and checking the results. The larger the original, the more useful is this function.
 - ◇ To simplify the test copy operation, you are recommended to decide a setting range for the test copy and register it in the memory. Then you can check the test copy only by loading the memory. (📖 page 100)

Note

- ◆ When this function is selected,
 - The original size setting is disabled. The Printer scans the original, synchronizing with the original size.
 - The frame erase setting is disabled.
 - The Printer outputs the original normally from the printer front side. Note that the Printer outputs the original from the rear side only when the distance specified below exceeds 1219.2mm (48 inches).
 - From: Original's front end
 - To: Partial copy's rear end
- ◆ When the partial copy length is set to 0, the partial copy function is disabled, and the Printer issues a normal copy print.

-
- ◆ The Printer does not copy with the value specified as follows.
 - The distance specified below is longer than the original length.
 - From: Original's front end
 - To: Partial copy start position
 - The distance specified below is longer than the maximum scannable original length.
 - From: Original's front end
 - To: Partial copy's rear end

Adjusting the Background

With this function, before copying an original with the defect below, its background color is removed.

- High background density;
- Light smears; or
- Folds casting strong shadows

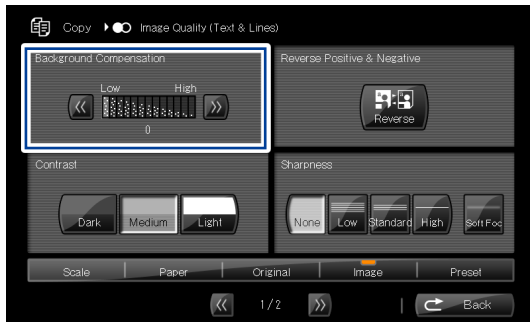

Background compensation is adjusted in 13 levels. The higher the number, the greater the deleted background color. The lower the number, the greater the remaining background color.

Original with Background Color

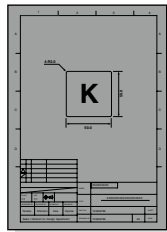

Original with Light Dirt

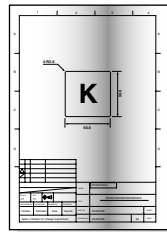

13

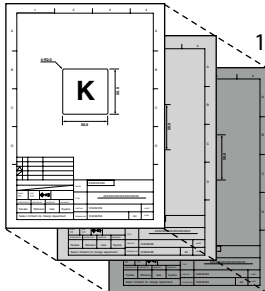

13

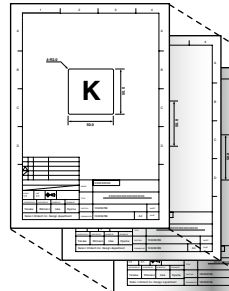

Note

- ◆ Note that the background setting changes if the original type is reselected after adjusting the background compensation (📖 page 31).

Adjusting the Original's Contrast

The brightness of the original can be adjusted.

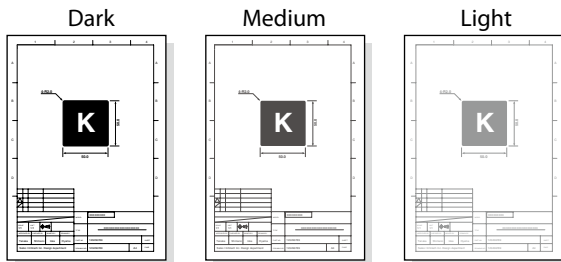
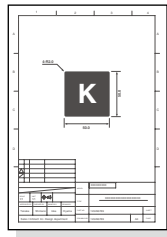
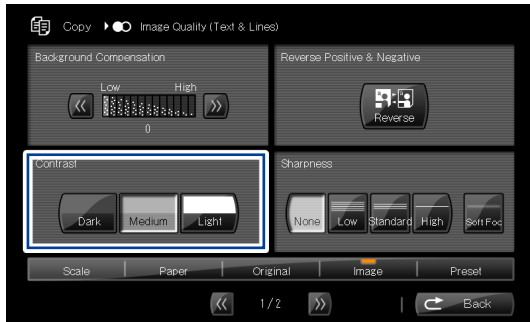

Adjusting the Original's Sharpness

The contours of the original can be sharpened or softened.



Note

- ◆ Note that the original's sharpness setting changes if the original type is reselected after adjusting the original sharpness (📖 page 31).

Performing White on Black Reverse

The white and black of the original can be reversed before copying.

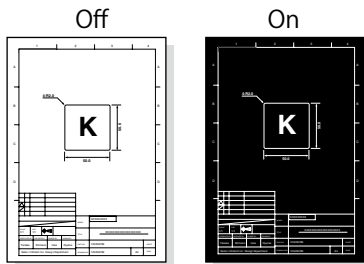
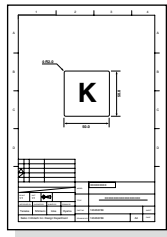

Setting the Scale

The original's size can be scaled before copying.

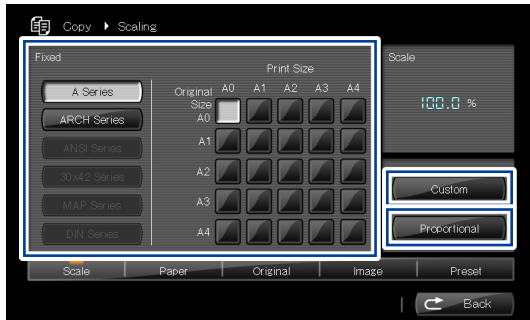

■ Fixed

Enables the easy selection of a ratio that scales to a size in the same standard as the original.

Examples: A1→A0 (141%), A0→A1 (70%)

■ Proportional

Scales while keeping the same ratio between the vertical and horizontal dimensions of the original.

■ Custom

Scales with separate ratios for the vertical and horizontal dimensions of the original.

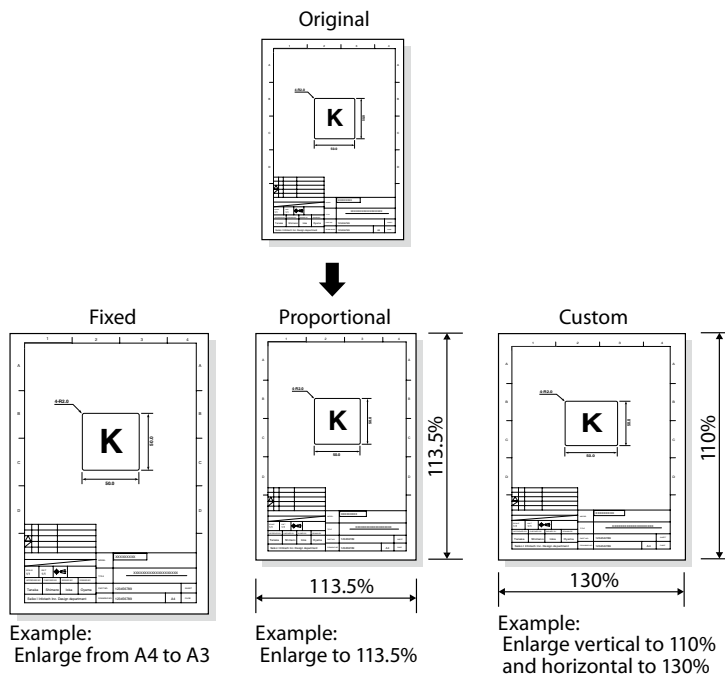

Adding Blank Space

Blank space can be added to the front and rear (front end and rear end) of the original before copying.

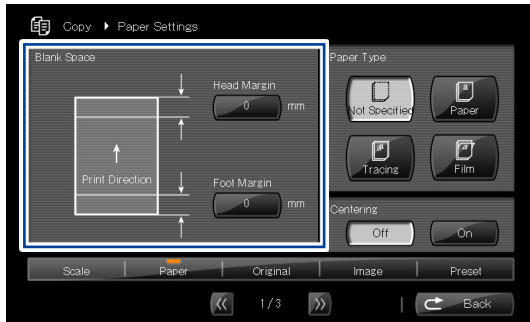

Note

- ◆ This setting is enabled only when the original size is set to **Synchro Scan** (📖 page 34).

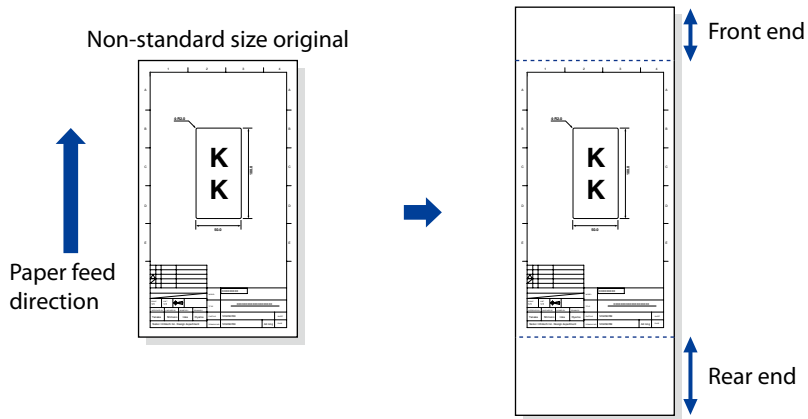

Selecting the Paper Type

From the types of the paper installed in the Printer, select your intended paper type for copying.

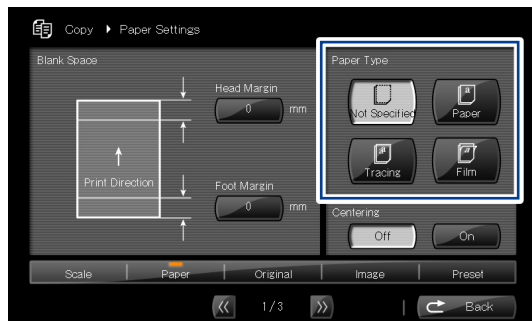

Chapter
1

Before Use

Chapter
2

Copy Function

Chapter
3

Submission
Function

Chapter
4

Preset Functions

Chapter
5

Scan Function

Chapter
6

Troubleshooting

Centering scan image

The scan image can be printed at the center of the paper width.

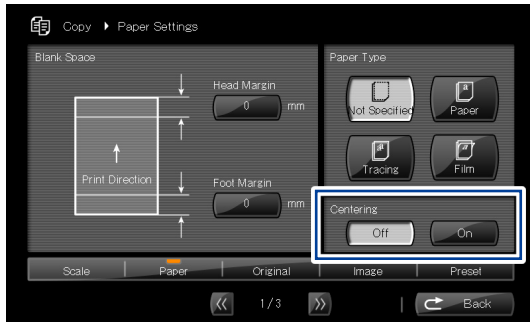

Note

- ◆ Centering is effective on the conditions below:
 - Roll Position setting is not Auto.
 - Original Size is set to Synchro Scan.

Erasing the Frame

Chapter
1

Before Use

Chapter
2

Copy Function

Chapter
3

Submission Function

Chapter
4

Preset Functions

Chapter
5

Scan Function

Chapter
6

Troubleshooting

The area around the original can be erased before copying, so that the original's frame is erased.

Note that this function is available only for standard size originals.

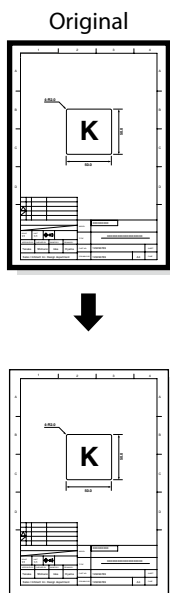
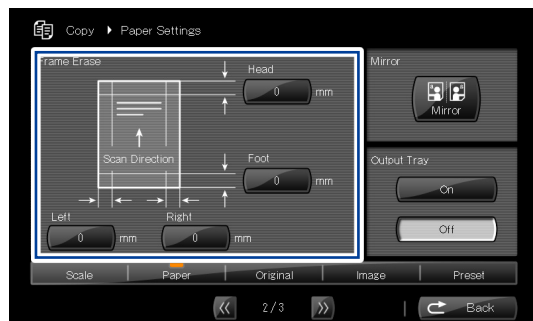

Note

- ◆ This setting is enabled only when the original size is set to **Portrait** or **Landscape** (📖 page 34).

Selecting the Paper Output Slot

Select the output slot for the paper.

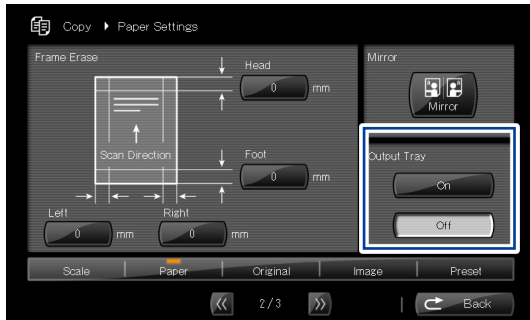

■ Output Tray On

Outputs to the tray when the print size is A3 or less. Other sizes are output to the paper outlet slot.

■ Output Tray Off

By setting Output Tray to Off, the Printer outputs all sizes to the paper outlet slot.

Performing Mirror Reverse

Mirror reverse can be performed for the original before copying.

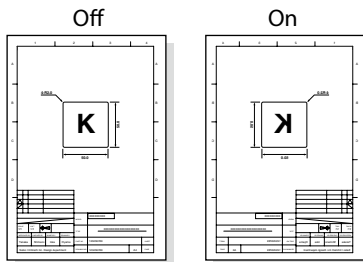
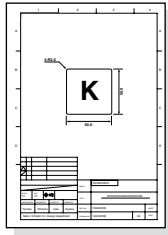

Chapter
1

Before Use

Chapter
2

Copy Function

Chapter
3

Submission Function

Chapter
4

Preset Functions

Chapter
5

Scan Function

Chapter
6

Troubleshooting

Entering the Number of Copies

Enter the number of copies.



Note

- ◆ To enable the entry of the number of copies, configure the settings, and then press the **Back** button to return to the Copy top screen.
- ◆ Up to 999 copies are available for one operation. If a higher number is entered, the setting is invalid.

Performing a Moderate Scan

When Moderate Scan is set to On, the Printer feeds the original moderately to prevent the original from being damaged.

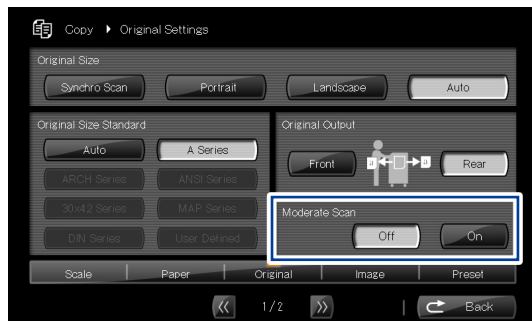

Note

- ◆ Even with Moderate Scan set to On, the Printer may not be able to feed the original moderately depending on the settings of the copy scale ratio and submission resolution.

Copying an Original with Text & Lines

Check the following settings to make a clear copy of an original with text and lines.

■ Automatic binary threshold

This parameter activates or deactivates the binarization threshold automatic setting.

Choices: Off

On (default)

Normally, keep this parameter to On.

If the copy output is unclear with the parameter to On, set it to Off and enter a threshold value.

■ Binary threshold

Set the threshold value for binarization.

Enter a numeric value between 0 and 255 (default: 120).

The higher the value, the higher the image density.

The lower the value, the lower the image density.

When the automatic binary threshold is set to On, the Printer generates automatically a threshold value, which is displayed as a reference. Use this reference to choose a value when you enter the threshold manually.

Copying a Blueprint Original

Chapter
1

Before Use

Chapter
2

Copy Function

Chapter
3

Submission Function

Chapter
4

Preset Functions

Chapter
5

Scan Function

Chapter
6

Troubleshooting

Check the following settings to make clear copy of a blueprint original.

■ Automatic binary threshold

This parameter activates or deactivates the binarization threshold automatic setting.

Choices: Off

On (default)

Normally, keep this parameter to On.

If the copy output is unclear with the parameter to On, set it to Off and enter a threshold value.

■ Binary threshold

Set the threshold value for binarization.

Enter a numeric value between 0 and 255 (default: 120).

The higher the value, the higher the image density.

The lower the value, the lower the image density.

When the automatic binary threshold is set to On, the Printer generates automatically a threshold value, which is displayed as a reference. Use this reference to choose a value when you enter the threshold manually.

■ Original density disparity

Set the density disparity of the original.

Choices: Large

Small

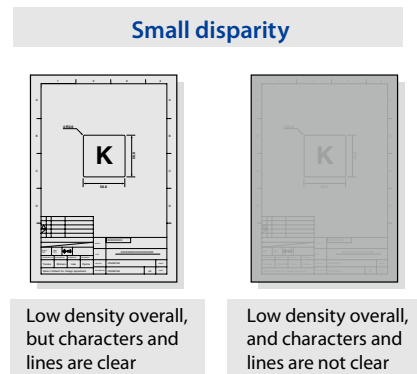
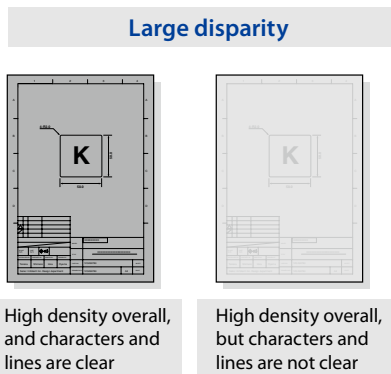

Sorting

Multiple originals can be stored temporarily in the Printer to perform collated copy such as sort copy or stack copy.

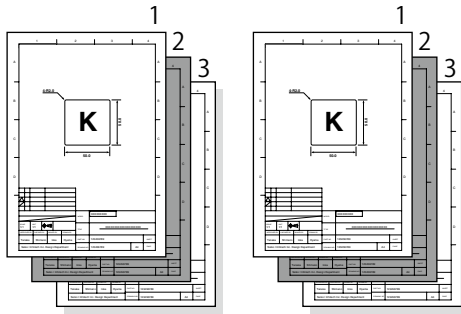
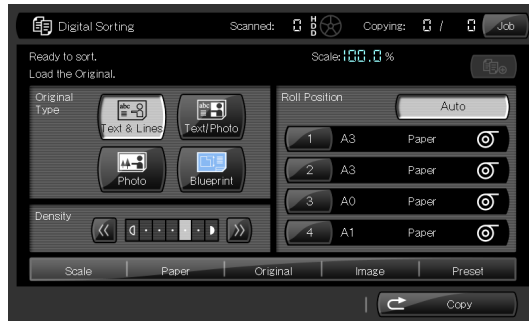

Up to 750 sheets of data can be stored with the digital sort function.

Note

- ◆ Larger image sizes reduce the number of images that can be stored.

Example:

- With A4 image size, max. 750-sheet images are stored.
- With A0 image size, max. 100-sheet images are stored.



- ◆ **TIP** While printing a digitally sorted job, the digital sort function can scan originals of the next digitally sorted job.

Up to four jobs can be scanned in advance.



- ◆ **TIP** After digital sorting, press Copy to return to the copy mode. Note that the Printer returns to the copy mode only after the digitally sorted job processing is completed. To return to the copy mode during the processing, exit the digitally sorted job at the job screen.

Sorting Flow

This section describes the basic operation flow for digital sorting.



When authentication is necessary, enter a username and password, or PIN code.
For more details, see [Chapter 4](#) in the separate *User's Manual for Basic Printer Operation*.

Copy's top screen



Press Digital Sorting

Sort's top screen

Select the Original Type
Select the image quality type of the original. (page 31)

Select the Roll Position
From the paper types installed in the Printer, select the paper type for copying. (page 33)
With the default setting AUTO, the Printer automatically selects the paper to be printed on.

Press Original

Original Settings screen

Select the Original Size

Select the size of the original.
 (📖 page 34)
 With the default setting AUTO, the Printer automatically selects the paper size.



Press Scale



Scaling screen

Setting the Scale

Set to enlarge or reduce the original's size. (📖 page 46)

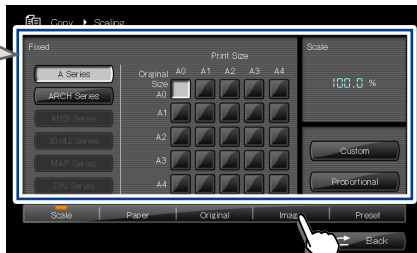

Press Image



Image Quality screen

Adjust the Background

Adjust the background color for originals with an uneven density. (📖 page 42)

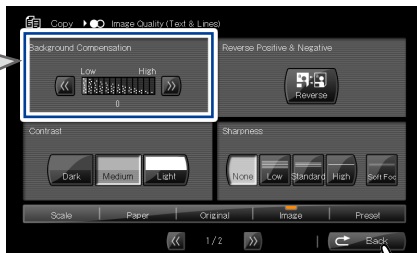

Press Back



Load the original

Load the original into the Printer. (📖 page 22)



Press START

When **Start Scanning** is set to **Original Setting** in the System menu, copying and submission start automatically even if **START** is not pressed.

For more details, see **Chapter 3** in the separate **User's Manual for Basic Printer Operation**.



TIP Each time the Cancel key is pressed at the Digital Sort top screen, data is deleted starting from the end of the stored data.

Scan all originals



Sort's top screen

The number of scanned originals is displayed.



Press ENTER



Set
Enter the number of copies.
Sort
Specify the collation method.
Print order
Specify the print order.

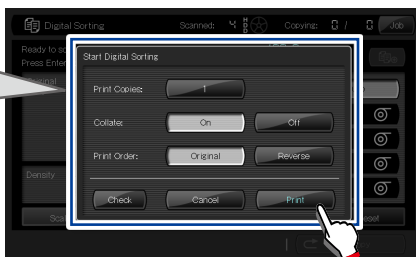

Press Print

Output order configured by the sorting and printing order settings when printing three copies of three originals.

	Collate	Print Order
Original	123, 123, 123	111, 222, 333
Reverse	321, 321, 321	333, 222, 111

Test Printing Sorted Originals

You can test print the most recently scanned original of the originals stored using the digital sort function.

This is useful for checking for scan warping and image quality.

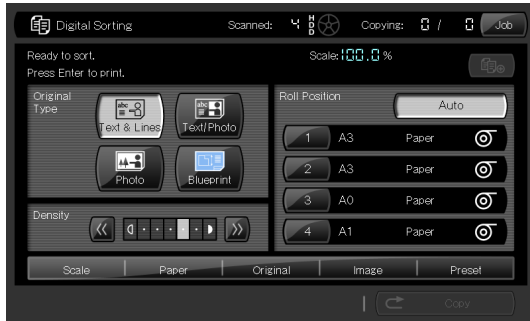

Press **ENTER**.



If the **Check** button is pressed, one sheet only of the most recently scanned original is printed.

To delete this original, press **CANCEL**.

To continue scanning, set the original.

Additionally Copying the Sorted and Printed Originals

Chapter
1

Before Use

Chapter
2

Copy Function

Chapter
3

Submission Function

Chapter
4

Preset Functions

Chapter
5

Scan Function

Chapter
6

Troubleshooting

Originals printed using the digital sort function can be copied additionally without scanning again.

Additional copies can be made for the job most recently digitally sorted and printed only.

Note

- ◆ The following actions disable additional copying.
 - Returning to standard copy mode.
 - Performing the next digital sorting.

If printing using the digital sort function is complete, the Add copies button appears.

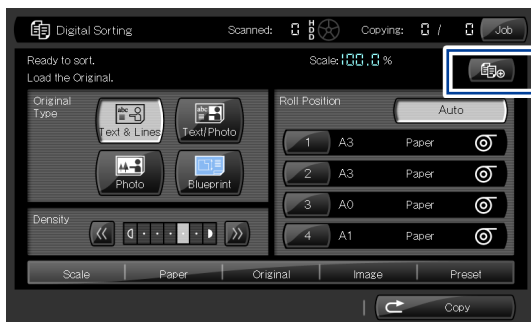

Press the Add copies button to display the Reprint screen. Configure the number of copies, sorting, and print order, and then press the **Print** button.

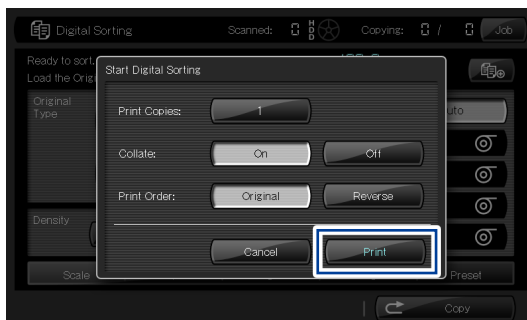

Initializing the Setting

The Printer initializes the setting for the copy operation, and returns to the initial status.

Chapter

1

Before Use

Chapter

2

Copy Function

Chapter

3

Submission Function

Chapter

4

Preset Functions

Chapter

5

Scan Function

Chapter

6

Troubleshooting

Handling copy jobs

Chapter
1

Before Use

Chapter
2

Copy Function

Chapter
3

Submission Function

Chapter
4

Preset Functions

Chapter
5

Scan Function

Chapter
6

Troubleshooting

To display the copy job screen, press Job on the Copy Top screen.

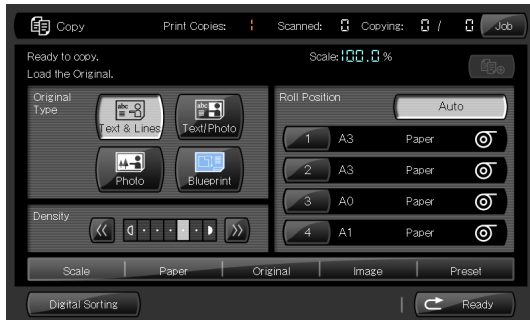

At the Copy Job screen, the job under processing can be cancelled by pressing the **x** button.



To cancel the job under processing, press **Yes**.

Additionally copying the Copied Originals

Copied originals can be copied additionally without scanning again. Additional copies can be made for the job last copied only.

Note

- ◆ The following actions disable additional copying.
 - Print data was received after copy printing.
 - The panel was switched to a mode other than the standard copy mode screen.

If copying is complete, the Add copies button appears.

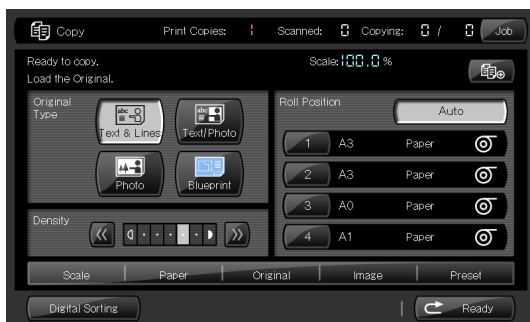

Press the Add copies button to display the Reprint screen. Configure the number of copies, and then press the **Print** button.

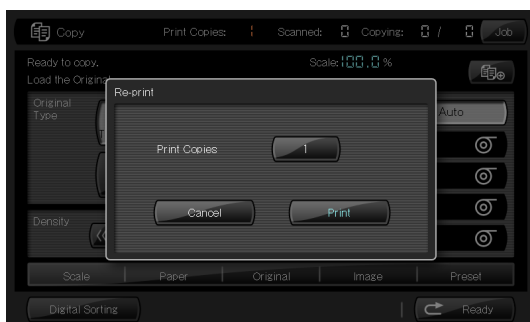

Chapter
1

Before Use

Chapter
2

Copy Function

Chapter
3

Submission
Function

Chapter
4

Preset Functions

Chapter
5

Scan Function

Chapter
6

Troubleshooting

Chapter 3

Submission Functions

This chapter describes the submission functions of the Printer.

Chapter Contents

▼ Submission Functions Outline.....	68
▼ Preparing the network and host computer	70
▼ Submission Operation Flow	72
▼ Submission Function Overview	84
▼ Selecting Scan Color Mode	85
▼ Selecting Original Type.....	86
▼ Selecting Scan Resolution.....	87
▼ Selecting the File Format for Images to be Scanned	88
▼ Configuring the Filename for Images to be Scanned	90
▼ Submission and Copy in One Operation	92
▼ Print Copies	93
▼ Print Quality	94
▼ Handling Image Submission Jobs.....	95
▼ Handling Printer Submission Jobs.....	96
▼ Reprinting through Printer Submission	97

Submission Functions Outline

The Printer has the following 4 submission functions.

■ Image submission function

With this function, the Printer submits images scanned with the Printer to:

- shared folders; and
- FTP servers

on the host computers connected to an IPv4/IPv6 network.

Up to 100 destinations can be registered.

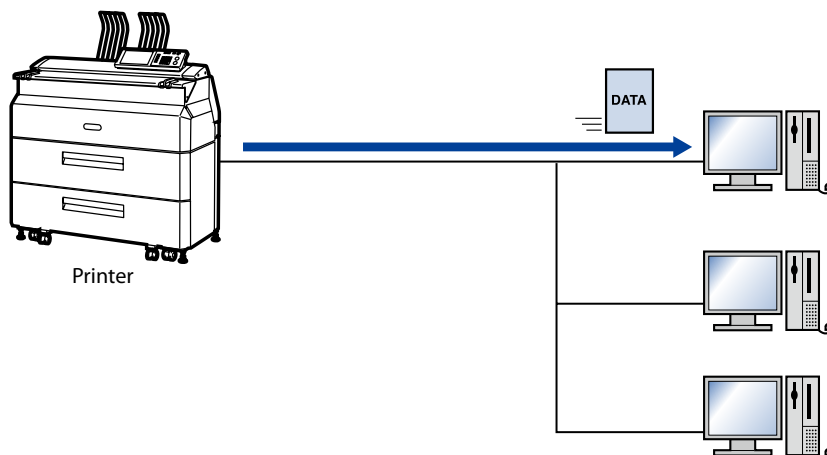

TIP ◇ If Web functions are used, registration in multiple languages is possible.

■ Submission job box function

With this function, image data scanned with the Printer are stored in the submission job box of the Printer.

Up to 99 image files can be saved in the submission job box with a maximum capacity of 80GB.

Images stored in the submission job box can be submitted to shared folders on host computers using the thumbnail submission function or retrieved using the web function.

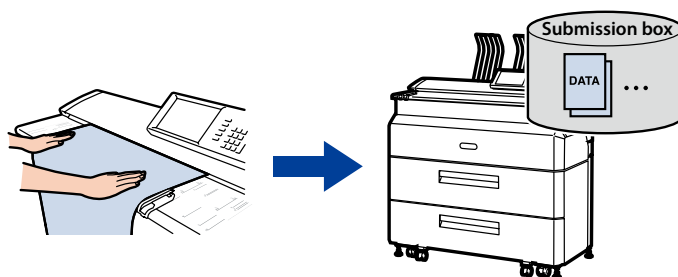

■ Thumbnail submission function

A list of thumbnails is shown on the operation panel for image data stored in the submission box. With this function, you can select image data from the list and submit it to shared folders on host computers connected to an IPv4/IPv6 network. In addition, image data stored in the submission box can be accessed from a web browser using the web function.

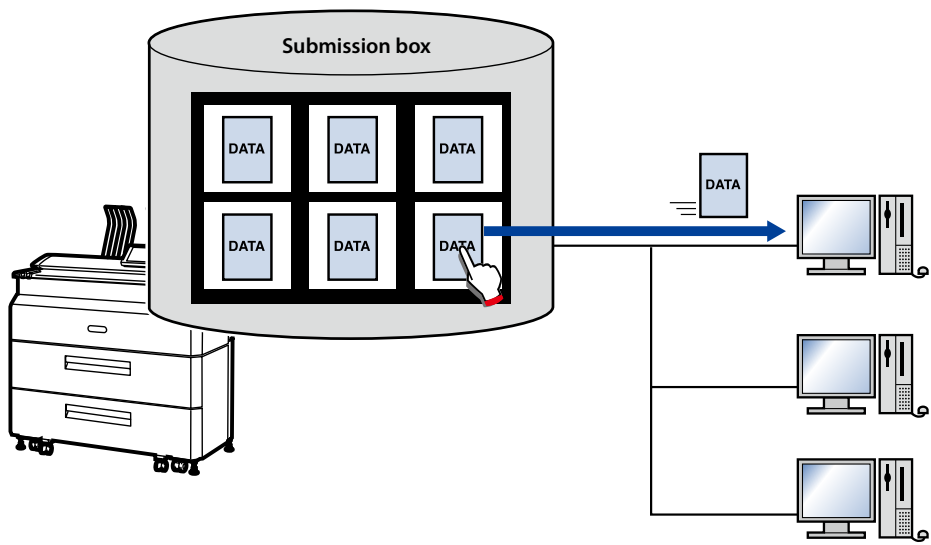

■ Printer submission function

With this function, color image data scanned with the Printer are printed with another printer. Up to 5 submission destinations can be registered.

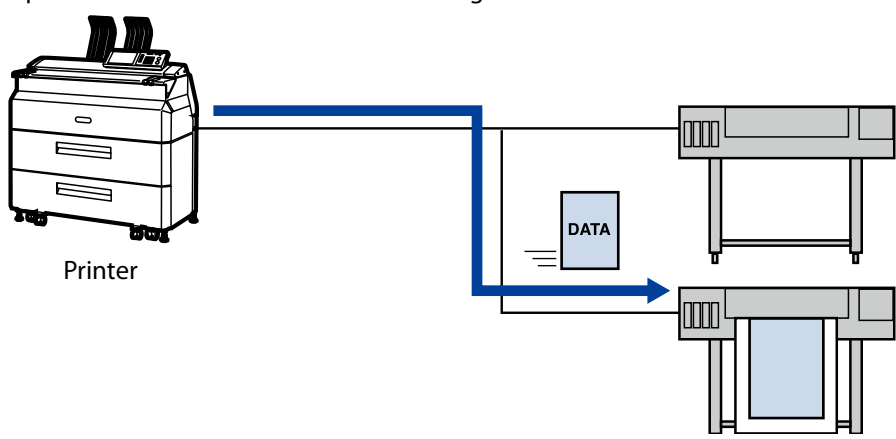

Note

- ◆ To scan in color mode, the optional Color Scan Upgrade (LP-857) is required.

Preparing the network and host computer

Chapter
1

Before operating submission functions, check your printer's network connection and the shared folder on the host computer.

Before Use

Chapter
2

◆ Checking the Printer's Network Connection

Copy Function

Check that the IP address, subnet mask, and gateway address of the Printer are set correctly. For more details, see the **Chapter 3** in the separate *User's Manual for Basic Printer Operation*.

Chapter
3

◆ Creating a Shared Folder

Submission Function

On the host computer, create a shared folder to which you will send the image data.

Chapter
4

Note

Preset Functions

- ◆ Assign write permission to the shared folder.
- ◆ You are recommended to install the host computer on the same LAN as the Printer to:
 - Minimize the Printer's operation time decrease caused by the scanned data transmission delay; and
 - Prevent the scanned data leakage.

Chapter
5

Scan Function

Chapter
6

Troubleshooting

◆ Preparing a printer to receive submissions

The Printer supports submission to the printers with:

- Language supporting the HP RTL / PDF format
- Communication protocol supporting LPR/RAW

For more information about recommended printers, contact our service representative.

Submission Operation Flow

Make sure the preparations for operating the submission functions (📖 page 70) have been completed before performing these operations.

◆ Submitting images (SMB connection)



When authentication is necessary, enter a username and password, or PIN code.
For more details, see [Chapter 4](#) in the separate *User's Manual for Basic Printer Operation*.

Submit's top screen

Select the destination.

Press the number of the job you intend to add or edit, and press **Add/Edit**.

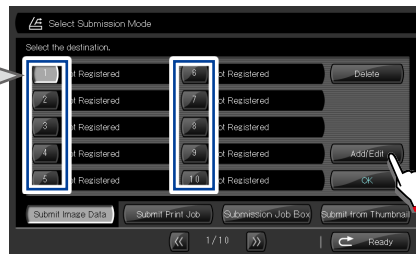

Press Add/Edit

The destination of the image submission function can also be handled as the destination for the thumbnail submission function.

Add or Edit Image Destination screen (1/2)

Set up the destination.

Set the protocol to SMB and set the shared folder of the destination.



Press >>

Set the presets.
 If frequently used settings are set in the preset memory, the presets can be called automatically when the submission destination is selected. For details of preset functions, see [page 99](#).

Save the settings.
 If the Save button is pressed, the settings are saved and the connection to specified shared folder is confirmed. If the connection cannot be confirmed, check the settings.

Add or Edit Image Destination screen (2/2)

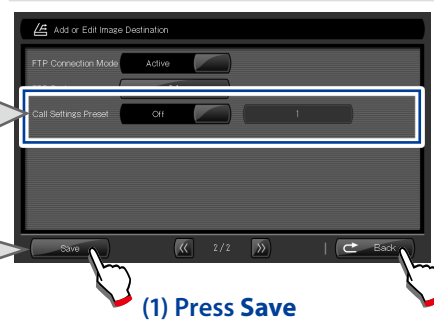

The following actions can be performed by using the Web functions.
 Copy submission destinations
 Import/export submission destinations
 For more details, see [Chapter 2](#) in the separate *User's Manual for Basic Printer Operation*.

Submit's top screen

Select the destination.
 Select the number of the destination and press **OK**. Then the Printer checks the connection to the destination selected. If the Printer is unable to check the connection successfully, review the condition of the computer for submission.

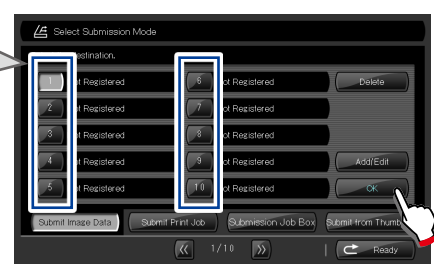

Functions Setting screen

Specify the functions for submission.
 For the supported functions, see the [page 84](#).

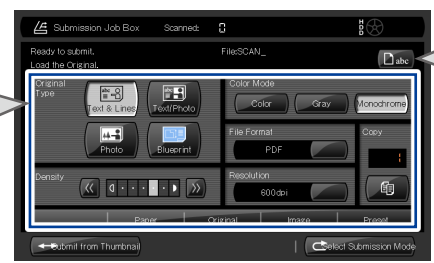

To specify a file name, press **abc** and enter the file name. As default the file name is automatically generated.

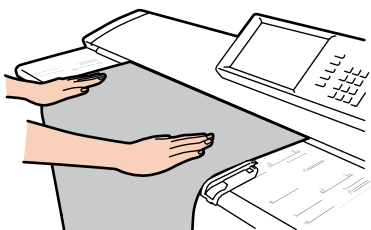

Load the original

Load the original into the Printer. (📖 page 22)



Press START

When **Start Scanning** is set to **Original Setting** in the System menu, the Printer starts scanning the original automatically without **START** pressed.

For more details, see **Chapter 3** in the separate *User's Manual for Basic Printer Operation*.

◆ Submitting images (FTP connection)



When authentication is necessary, enter a username and password, or PIN code.
For more details, see [Chapter 4](#) in the separate *User's Manual for Basic Printer Operation*.

Submit's top screen

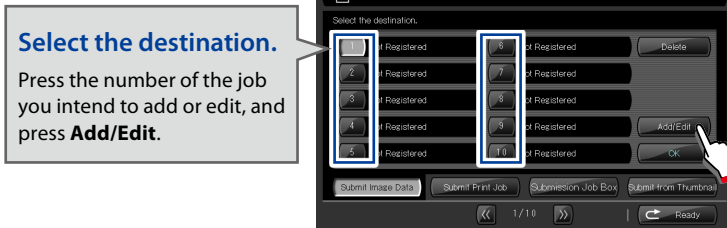

Press Add/Edit

The destination of the image submission function can also be handled as the destination for the thumbnail submission function.



Add or Edit Image Destination screen (1/2)



Press >>





Set up the FTP connection.

Specify the FTP connection method and FTP ports. Generally, the default FTP port is acceptable.

Save the settings.

If the Save button is pressed, the settings are saved and the connection to specified shared folder is confirmed. If the connection cannot be confirmed, check the settings.

Add or Edit Image Destination screen (2/2)



(1) Press Save

(2) Press Back

Set the presets.

If frequently used settings are set in the preset memory, the presets can be called automatically only with the submission destination selected. For details of preset functions, see [page 99](#).

The following actions can be performed by using the Web functions.
Copy submission destinations
Import/export submission destinations
For more details, see [Chapter 2](#) in the separate *User's Manual for Basic Printer Operation*.



Submit's top screen

Select the destination.

Select the number of the destination and press **OK**. Then the Printer checks the connection to the destination selected. If the Printer is unable to check the connection successfully, review the condition of the computer for submission.

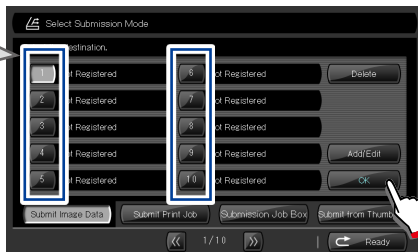

Press OK



Functions Setting screen

Specify the functions for submission.

For the supported functions, see the [page 84](#).



To specify a file name, press and enter the file name. As default the file name is automatically generated.



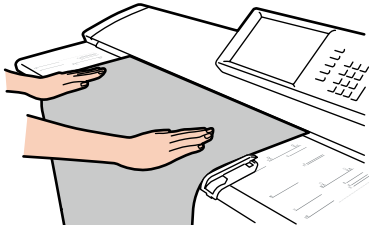

Load the original

Load the original into the Printer. (📖 page 22)



Press **START**

When **Start Scanning** is set to **Original Setting** in the System menu, the Printer starts scanning the original automatically without **START** pressed.

For more details, see **Chapter 3** in the separate *User's Manual for Basic Printer Operation*.

◆ Storing image data in the submission job box



When authentication is necessary, enter a username and password, or PIN code.
For more details, see **Chapter 4** in the separate *User's Manual for Basic Printer Operation*.

Submit's top screen

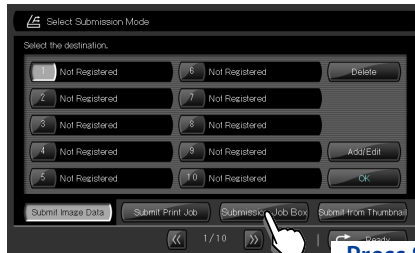

Press Submission Job Box



Functions Setting screen

Specify the functions for submission.
For the supported functions, see the **(page 84)**.



To specify a file name, press **[abc]** and enter the file name. As default the file name is automatically generated.



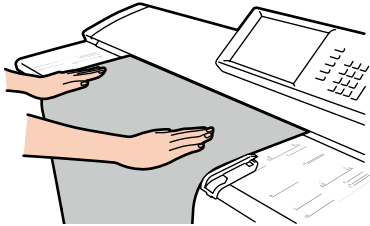

Load the original

Load the original into the Printer. (📖 page 22)



Press START

When **Start Scanning** is set to **Original Setting** in the System menu, the Printer starts scanning the original automatically without **START** pressed. For more details, see **Chapter 3** in the separate *User's Manual for Basic Printer Operation*.

◆ Submitting thumbnails



When authentication is necessary, enter a username and password, or PIN code.
For more details, see [Chapter 4](#) in the separate *User's Manual for Basic Printer Operation*.

Submit's top screen

Select the destination.
Press the number of the job you intend to add or edit, and press **Add/Edit**.

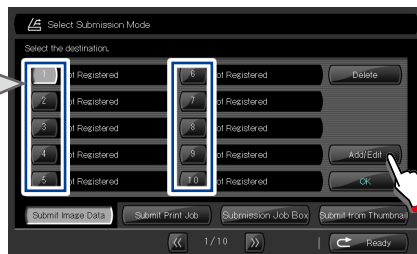

Press Add/Edit

The destination of the thumbnail submission function can also be used as the destination for the image submission function.



Add or Edit Image Destination screen

Set up the destination.
Create a shared folder at the destination.
Press **SAVE** to save the shared folder settings and to check the connection to the created shared folder.
If the Printer is unable to check the connection successfully, review the settings.



(1) Press Save

The following actions can be performed by using the Web functions.
Copy submission destinations
Import/export submission destinations
For more details, see [Chapter 2](#) in the separate *User's Manual for Basic Printer Operation*.

(2) Press Back



Two submission destination settings are available: SMB connection and FTP connection.
For details, see [page 72 Submitting images \(SMB connection\)](#) and [page 75 Submitting images \(FTP connection\)](#).

Submit's top screen

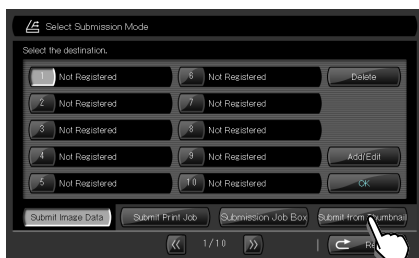

Press **Submit from Thumbnail**

Thumbnail submission screen

Select the image data to be submitted

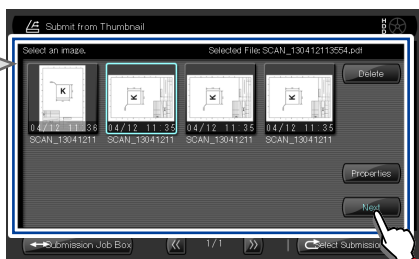

Press **Delete** to delete the selected images.
 Press **Detailed Information** to view **detailed information** about selected images or prohibit automatic deletion. For details, see **Chapter 3, Job Box Retention Period** in the separate **User's Manual for Basic Printer Operation**.

Press **NEXT**

Select the destination.

Select the number of the destination and press **OK**. Then the Printer checks the connection to the destination selected. If the Printer is unable to check the connection successfully, review the condition of the computer for submission.

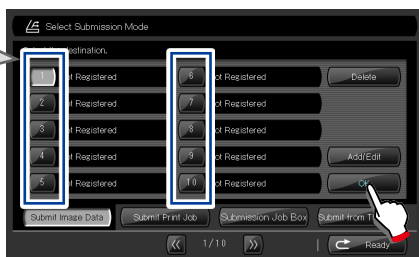

Press **OK**

Thumbnail submission

The thumbnail submission screen is displayed and the selected image is sent. Wait until the transmission is complete to perform the next submission.

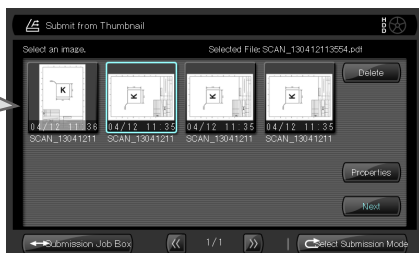

◆ Submitting to a printer



When authentication is necessary, enter a username and password, or PIN code.
For more details, see **Chapter 4** in the separate *User's Manual for Basic Printer Operation*.

Submit's top screen



Press **Submit Print Job**



Select the destination.
Press the number of the job you intend to add or edit, and press **Add/Edit**.

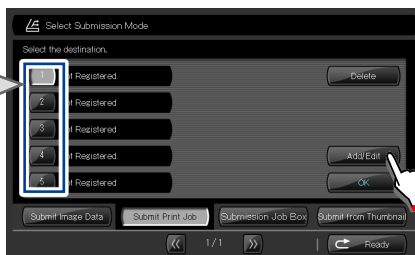

Press **Add/Edit**



Add or Edit Image Destination screen

Set up the destination.
Specify the destination printer.
Press **Save** to save the settings and to check the connection to the specified printer.
If the Printer is unable to check the connection successfully, review the settings.

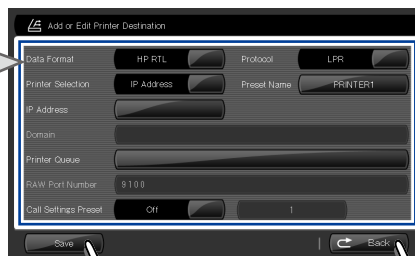

(1) Press **Save**

The following actions can be performed by using the Web functions.
Copy submission destinations
Import/export submission destinations
For more details, see **Chapter 2** in the separate *User's Manual for Basic Printer Operation*.

(2) Press **Back**



Submit's top screen

Select the destination.

Select the number of the destination and press **OK**. Then the Printer checks the connection to the destination selected. If the connection cannot be checked, review the condition of the printer for submission.

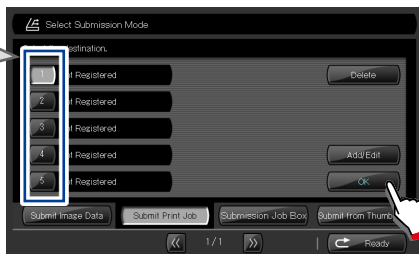

Press **OK**

Functions Setting Screen

Specify the functions for submission.

For the supported functions, see the (📖 page 84).

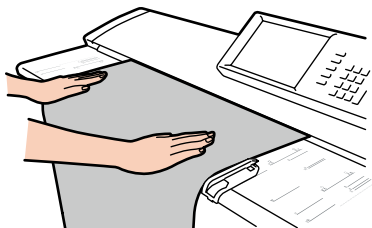

Load the original

Load the original into the Printer. (📖 page 22)

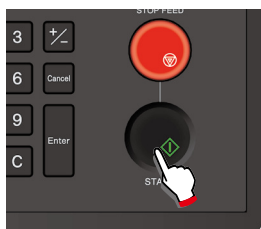

Press **START**

When **Start Scanning** is set to **Original Setting** in the System menu, the Printer starts scanning the original automatically without **START** pressed. For more details, see **Chapter 3** in the separate *User's Manual for Basic Printer Operation*.

Submission Function Overview

The submission functions available with the Printer are listed below. For details of the procedure to set the functions starred, see the **Chapter 2 Copy Functions**.

Function	Description
Original Size ★	Specify the size of the original. (📖 page 34)
Original Type	Select an image quality type appropriate for the original. (📖 page 86)
Background Compensation ★	Delete background colors. (📖 page 42)
Density ★	Adjust the scan density. (📖 page 32)
Mirror Reverse ★	Reverse the original and then scan. (📖 page 52)
Original Size Standard ★	Select the size standard of the original. (📖 page 38)
Original Output ★	Set the original output location. (📖 page 51)
Sharpness ★	Adjust the original's contour sharpness. (📖 page 44)
Contrast ★	Adjust the original contrast. (📖 page 43)
White on Black Reverse ★	Reverse the white and black of the original before scanning. (📖 page 45)
Resolution	Select the scan resolution. (📖 page 87)
Moderate Scan ★	Feed the original moderately to prevent the original from being damaged. (📖 page 54)
Original with text & lines ★	Adjust the image quality appropriate for the originals with text and lines. (📖 page 55)
Blueprint Original ★	Set the image quality appropriate for the blueprint original. (📖 page 56)
Color Mode	Select a scan color mode. (📖 page 85)
File Format	Select a image file format. (📖 page 88)
File Name Setting	Create a file name for the scan image data. (📖 page 90)
Print Copies	Set the number of copies to print (for printer submission). (📖 page 93)
Printer Quality	Set the print quality (for printer submission). (📖 page 94)
Copy	Perform both submission and copy with a single scan. (📖 page 92)

Selecting Scan Color Mode

Select a scan color mode from monochrome, grayscale, and color.

■ Monochrome

The scanner scans in monochrome binary format.

■ Grayscale

The scanner scans in monochrome multi-bit format.

■ Color

The scanner scans in color mode.

Note

- ◆ To scan in color mode, the optional Color Scan Upgrade (LP-857) is required.

Selecting Original Type

Set the original type for each color mode (monochrome/grayscale/color).

Monochrome

■ Text & Lines

Select for originals with mixed text and line art.

■ Text/Photo

Select for originals with mixed text and photos.

■ Photo

Select for general photos.

■ Blueprint

Select for blueprint originals.

Grayscale

The original type setting is not required.

Color

■ Text

Select for scanning texts mainly.

■ Text/Photo

Select for scanning texts mainly.

■ Photo

Select for scanning photos.

■ Map

Select for scanning maps.

Selecting Scan Resolution

Select the scan resolution from the options below.

- **150 dpi**

The scanner scans at 150 dpi.

- **200 dpi**

The scanner scans at 200 dpi.

- **300 dpi**

The scanner scans at 300 dpi.

- **400 dpi**

The scanner scans at 400 dpi.

- **600 dpi**

The scanner scans at 600 dpi.

Chapter
1

Before Use

Chapter
2

Copy Function

Chapter
3

Submission Function

Chapter
4

Preset Functions

Chapter
5

Scan Function

Chapter
6

Troubleshooting

Selecting the File Format for Images to be Scanned

Select the file format for image files to be created.

■ PDF file

Creates a scan image in the PDF file.

■ Multi-page PDF file

Creates a scan image in the multi-page PDF file.

■ TIFF file

Creates a scan image in the TIFF file.

■ Multi-page TIFF file

Creates a scan image in the multi-page TIFF file.

■ JPEG file

Creates a scan image in the JPEG file.

The supported file formats differ depending on the scan color mode.

File format	Scan color mode		
	Monochrome	Grayscale	Color
PDF	Yes	No	Yes
Multi-page PDF	Yes	No	Yes
TIFF	Yes	Yes	Yes
Multi-page TIFF	Yes	No	Yes
JPEG	No	No	Yes



TIP

◇ Multi-page PDF and Multi-page TIFF create a single PDF file or single TIFF file from multiple-page original, with Enter pressed after completing scanning.

Note

- ◆ Press Cancel to cancel the latest scan image, e.g., whose original was scanned obliquely.
- ◆ One file contains 99 pages at maximum.
- ◆ If the hard disk capacity is exceeded, no more image can be scanned.
- ◆ During the multi-page scan, scan color mode, file format, and file name cannot be changed.
- ◆ With JPEG selected, the maximum scan length depends on the setting of the resolution as follows.
150dpi: 11096mm (436.85 inches), 200dpi: 8322mm (327.64 inches),
300dpi: 5548mm (218.42 inches), 400dpi: 4161mm (163.82 inches),
600dpi: 2774mm (109.21 inches)



- TIP**
- ◇ The scannable original length changes depending on the color mode, file format, resolution, and original width. For details to scan lengthy documents, contact your dealer or the nearest service representative.
 - ◇ During multi-page scan, the scannable number of pages changes depending on the file format, resolution, original width, and original length. For details about multipage scan, contact your dealer or the nearest service representative.
 - ◇ The image size that can be displayed on a PC changes depending on the operating system, the application software, and the memory of the PC and the hard drive.

Configuring the Filename for Images to be Scanned

Set the name for files to be created. By default, the Printer automatically generates a filename by appending the scan date and time (year, month, day, hours, minutes, and seconds of scanning) to the basic filename for image data submission.



TIP ◇ Example:

Basic filename for image data submission: scan_
Scan date and time: 12:34:56 of on September 30, 2010
The Printer automatically generates the File name as:
scan_100930123456.pdf

An extension is added to the file name depending on the file format setting:

- PDF: .pdf
- TIFF: .tif
- JPEG: .jpg

To configure a filename of your choosing, configure the following settings.

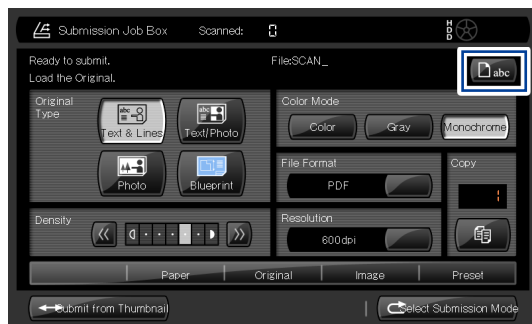

Press the **abc** button and configure the settings at the screen shown below.



■ Filename

Specify a filename of your choosing. The permitted length range for filenames is 1 to 60 characters.

■ Overwrite if filename exists

Specify whether to overwrite if a file with the same filename is in the submission destination folder.

■ Date and time

The year, month, day, hours, minutes, and seconds of scanning is appended to the filename you chose.

■ Serial number

A serial number is appended to the filename you chose.

The serial number can be configured from 001 through 999.



TIP ◇ When the sequential number reaches 999, the next number is 001.

■ None

Filename of your choosing only.

■ Start number

When the file naming setting is Sequential number, set the start number for the sequential number.

The sequential number setting adds three digits automatically.



TIP ◇ The sequential number 1 becomes 001.

■ Reset

Return the start number for the Sequential number setting to 1.

Submission and Copy in One Operation

With a single scan, you can create an image file and then print a copy of that image in only one operation.

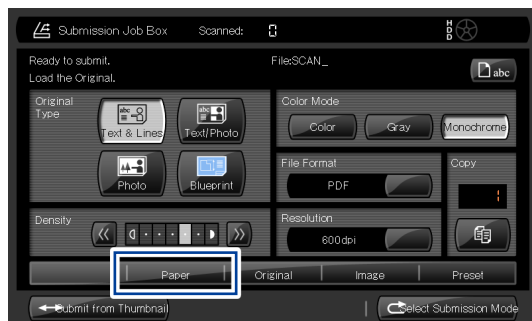

Press Paper in the Image Submission or Submission Box Top screen.



Configure Print Copies, Output Tray (📖 page 51), and Paper Type (📖 page 48), and then press Back.



TIP ◇ When you do not need to select the output tray and the paper type, press the Copy button in the Image Submission or Submission Box Top screen and enter only the number of copies.

Note

- ◆ When you continuously perform scanning operations, note that the Printer cannot scan again until the previous job printing is complete.
- ◆ If an error, such as lack of paper or paper jam, occurs during copy, switch to the copy function and check the error screen.

Print Copies

Set the number of copies to print before the printer submission.
The value can be set from 1 to 999 copies. (The default setting is 1.)

Chapter

1

Before Use

Chapter

2

Copy Function

Chapter

3

Submission Function

Chapter

4

Preset Functions

Chapter

5

Scan Function

Chapter

6

Troubleshooting

Print Quality

Set the print quality before the printer submission. The following settings are available.

- High Quality
- Standard (default setting)
- High Speed

Chapter

1

Before Use

Chapter

2

Copy Function

Chapter

3

Submission Function

Chapter

4

Preset Functions

Chapter

5

Scan Function

Chapter

6

Troubleshooting

Handling Image Submission Jobs

To display the Image Submission Job screen, press **Job** on the Image Submission Top screen.



Jobs being processed can be stopped on the Image Submission Job screen.



At the Submission Job screen, the job under processing can be cancelled by pressing the x button.

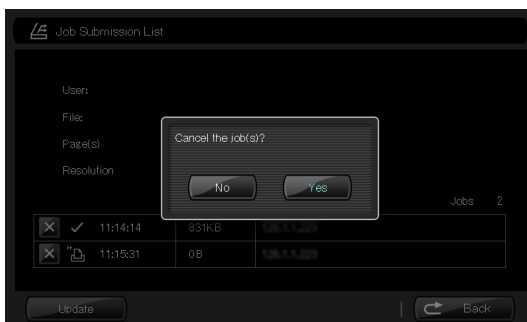

To cancel the job under processing, press **Yes**.

Handling Printer Submission Jobs

Chapter
1

Before Use

Chapter
2

Copy Function

Chapter
3

Submission Function

Chapter
4

Preset Functions

Chapter
5

Scan Function

Chapter
6

Troubleshooting

To display the Printer Submission Job screen, press **Job** on the Printer Submission Top screen.

The following operations can be performed on the Printer Submission Job screen.

- Stop jobs being processed
- Delete processed jobs
- Reprint (resubmit) the specified number of copies of processed jobs



At the Printer Submission Job screen, the job under processing can be cancelled.

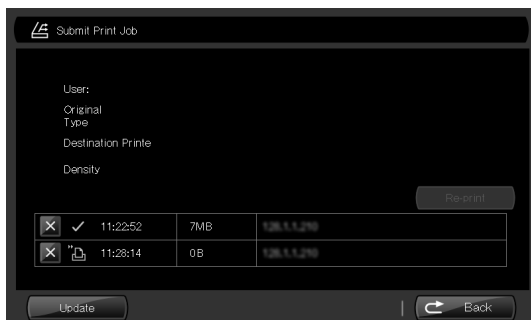

At the Printer Job screen, the job under processing can be cancelled by pressing the **x** button.



To cancel the job under processing, press **Yes**.

Reprinting through Printer Submission

When you want to print additional copies of originals printed using printer submission, you can print additional copies without scanning again.

Additional prints can be made for the most recently scanned job only.

When printing a large number of copies, you are recommended to use this function after checking for scan warping and image quality, which can prevent large-scale print mistakes.



After ending printer submission, press the **Job** button.



Press the **Reprint** button.



Enter the number of copies to be printed, and then press **Print**.

Chapter
1

Before Use

Chapter
2

Copy Function

Chapter
3

Submission
Function

Chapter
4

Preset Functions

Chapter
5

Scan Function

Chapter
6

Troubleshooting

Chapter 4

Preset Functions

This chapter describes the Printer's preset functions.

Chapter Contents

▼ Presets Overview.....	98
▼ Creating a preset in the Memory	99
▼ Calling a Preset from the Memory	100
▼ Saving Settings as Default Settings	101
▼ Changing a Preset Name	102
▼ Creating a Preset in the Memory for a Submission Destination.....	103

Presets Overview

Chapter
1

Before Use

Chapter
2

Copy Function

Chapter
3

Submission Function

Chapter
4

Preset Functions

Chapter
5

Scan Function

Chapter
6

Troubleshooting

The Printer must be given a description of the requirements of each copy and submission operation. You can save this description and call it when required. This description is called a preset.

You are recommended to save frequently used settings or complicated settings as presets, so that you do not have to enter the setting items or values.

When the settings for each submission destination are fixed, presets can be created in the memory for each submission destination.

With this function, presets can be called automatically by selecting a submission destination.

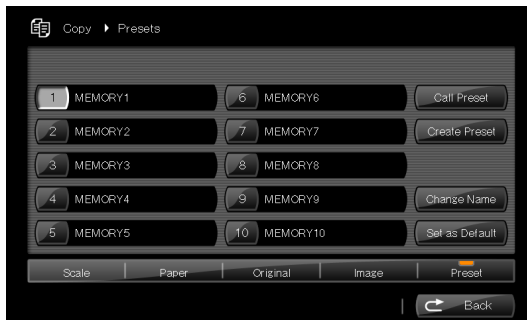

Creating a preset in the Memory

Various current setting conditions can be registered as presets in the memory. Up to 10 memory presets can be registered for each of the following modes.

- Copy mode
- Digital sorting mode
- Image submission
- Submission box
- Printer submission

The procedure to create a new preset is as follows.

- (1) Check your intended settings on the touchpanel, and press **Preset** to display the Preset screen on the touchpanel.
- (2) Press the number of the preset to which you want to save the settings and press **Create Preset**.

A pop-up screen is displayed to confirm settings of the preset.

If **Yes** is selected, the current settings are saved as the specified preset number.

Note

- ◆ Note that submission preset does not include the submission destination setting.

Calling a Preset from the Memory

Chapter

1

Before Use

Chapter

2

Copy Function

Chapter

3

Submission Function

Chapter

4

Preset Functions

Chapter

5

Scan Function

Chapter

6

Troubleshooting

Presets can be called up from the memory.

The procedure to call up a preset from the memory is as follows.

- (1) Press Preset to display the preset screen on the touchpanel.
- (2) Press Call Preset, and select the number of the preset you intend to call.
Then the current copy/submission settings are changed to the ones of the called preset.

Saving Settings as Default Settings

You can register the frequently used settings and complicated settings as the Printer's default settings instead of preset, so that the Printer returns to the settings after:

- The Printer powered on;
- The Printer reset; or
- The operation mode changed.

You are recommended to register the Printer settings as default, with which you always operate the Printer.

Settings can be saved as default settings for the following modes.

- Copy mode
- Digital sorting mode
- Image submission
- Submission box
- Printer submission

The procedure is as follows.

- (1) Press **Preset** to display the preset screen on the touchpanel.
- (2) Press Set as Default.

A pop-up screen is displayed to confirm settings of the preset.

If **Yes** is selected, the current settings are saved as the new default settings.

Note

- ◆ **Note that default settings does not include the submission destination setting.**

Changing a Preset Name

Chapter
1

Before Use

Chapter
2

Copy Function

Chapter
3

Submission
Function

Chapter
4

Preset Functions

Chapter
5

Scan Function

Chapter
6

Troubleshooting

The preset name can be changed.

You are recommended to change the preset name for easy identification, so that you can call the preset easily.

The procedure is as follows.

- (1) Press **Preset** to display the preset screen on the touchpanel.
- (2) Press Change Preset Name, and a popup screen appears. Enter a new preset name on the popup screen.

Then the current preset name is changed to a newly specified one.

Creating a Preset in the Memory for a Submission Destination

Make sure the preparations for operating the submission functions (📖 page 70) have been completed before performing these operations.

This function can be used with image submission and printer submission.



When authentication is necessary, enter a username and password, or PIN code.

For more details, see [Chapter 4](#) in the separate *User's Manual for Basic Printer Operation*.

Submit's top screen

Select the destination.

Select the submission destination for which you want to create preset in the memory.

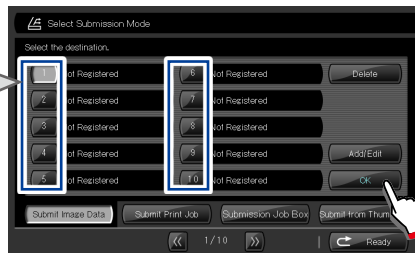

Press OK

The destination of the image submission function can also be handled as the destination for the thumbnail submission function.



Image Submission Top screen



Press Preset





Presets screen

Select a preset.
Select the preset to be set for the submission destination.

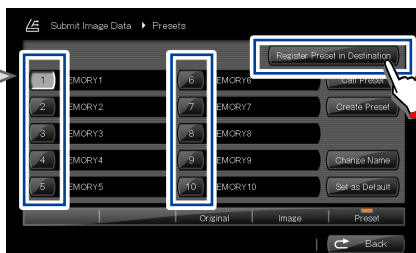

Press Register Preset in Destination

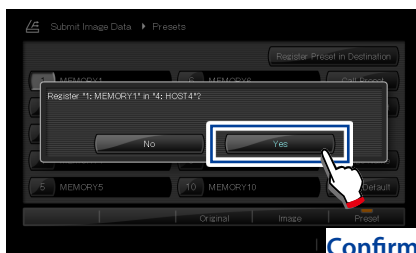

Confirm the settings, and then press Yes.

Chapter 5

Scan Functions

This chapter describes the scan functions of the Printer.

Chapter Contents

- ▼ Scan Functions Outline 106
- ▼ Preparing the network and host computer107
- ▼ Checking Operating Status with Message 108

Scan Functions Outline

Chapter
1

Before Use

Chapter
2

Copy Function

Chapter
3

Submission Function

Chapter
4

Preset Functions

Chapter
5

Scan Function

Chapter
6

Troubleshooting

To operate the scan function, change the Printer's mode by pressing SCAN. Then, from a computer connected to the network, operate the Printer to scan the original documents.

To operate this function, first install the special application, TerioStation (supplied as standard) on a computer connected to an IPv4/IPv6 network. Then operate this function with ScanToFile, which is one of the functions in the application.

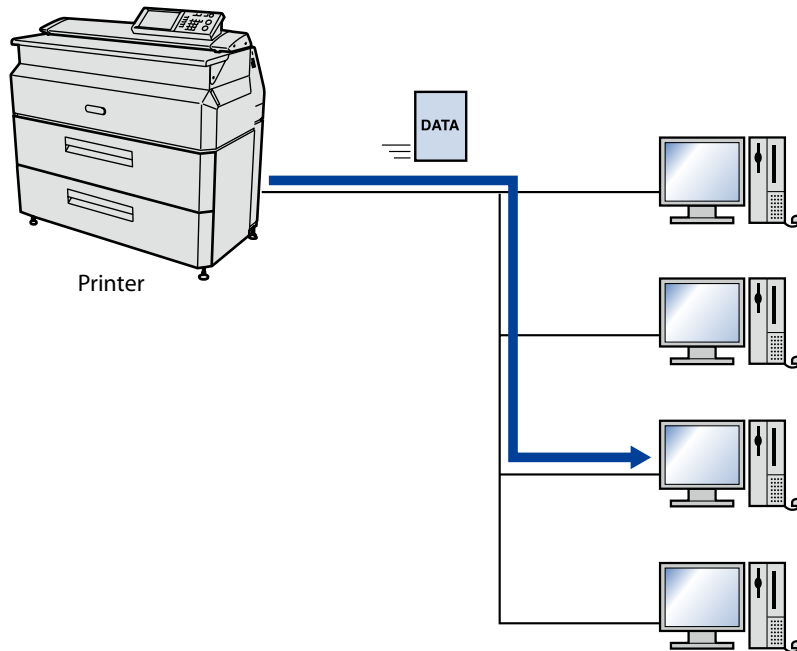

TIP ◇ With this function, the Printer scans color originals optionally.

Preparing the network and host computer

Before operating scan functions, check your printer's network connection and the application on the host computer.

◆ Checking the Printer's Network Connection

Check that the IP address, subnet mask, and gateway address of the Printer are set correctly. For more details, see the **Chapter 3** in the separate *User's Manual for Basic Printer Operation*.

◆ Installing the Exclusive Application (TerioStation)

For the installation procedure for the exclusive application (TerioStation), see the *TerioStation Installation Manual*.

◆ Configuring the Exclusive Application (TerioStation)

For the configuration method for the exclusive application (TerioStation), see the *TerioStation User's Manual*.

Checking Operating Status with Message

During the scan operation, you can check the operating statuses with the message on the screen as follows.

(1) Waiting for Scan Request

Press **SCAN** to show the screen below. This screen shows that the Printer is waiting for the request from the exclusive application (TerioStation) on the computer connected to the same network.

A message, **Waiting for Scan Request** appears on the screen.

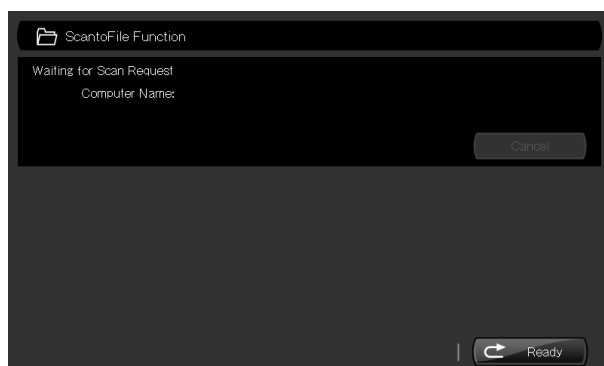

(2) Scanning from the Exclusive Application (TerioStation)

At the **Scan** or **Scan & Copy** tab of the exclusive application (TerioStation), configure the parameters and then press **Scan**.

The **ScanDriver** appears. Configure the settings and press the **Scan** button.

Note

- ◆ For the configuration method for the parameters of TerioStation, see the *TerioStation User's Manual*.

(3) Connection Display

When the Printer is connected to a computer and when it receives the scan request from the computer, the message changes to **Load the original**.

After the message appears, load the original.

To cancel the connection with the computer, press **Cancel** on the screen before loading the original.



(4) Ready to Start

When the original is loaded, the message changes to **Ready to Start**.

Then press **START** to start scanning.

When the **Start Scanning** has been set to **Original Setting** on the system menu, with the original loaded, the scanner automatically starts scanning.



(5) Scan Start

When the scanner starts scanning, the message changes to **Scanning...**
Press **Cancel** to stop the scanning job between the original scan start and the image submission end.



(6) Processing

When the scan operation is completed and when the image data processing starts for the transmission to the computer, the message changes to **Processing...**



(7) Transmitting

When the image data transmission starts, the message changes to **Transmitting...**



(8) Outputting Original

When the image data transmission is completed and while the original is still in the Printer, the message **Outputting...** appears.



Chapter 6

Troubleshooting

This chapter describes the action to take should a problem occur in your Printer. If the problem persists after taking the appropriate action, contact your dealer or nearest service representative.

Chapter Contents

- ▼ **Unclear Copying or Scanning** 113
- ▼ **Cannot Copy or Scan as Expected** 116
- ▼ **Improper Submission** 120

Unclear Copying or Scanning

Q. Black lines appear on scanned image or copy printout.

A. The shading guide or scanner glass is dirty.

- ➔ Clean the shading guide and scanner glass (📖 page 26).

Caution

- ◆ Before scanning or copying, remove any dirt from an original. If the original with dirt, e.g., toner, ink, or dust adherence is scanned or copied, the inside of the scanner may become dirty.
- ◆ When an original is long, copy or scan carefully so that it does not touch the floor.
- ◆ If you cannot remove a dirt from the original, copy or scan it with a carrier sheet.

Q. A fold in the original is copied or scanned in black.

A. The shadow of the fold was scanned.

- ➔ Before scanning, flatten the fold as flat as possible.
- ➔ Change the loading direction of the original (turn by 90°). Try scanning again.
- ➔ Increase the **Background Compensation** setting (📖 page 42).

Q. An image on the back of the original is scanned or copied.

A. With a thin original, image on the back side may appear on the front side, which is scanned or copied.

- ➔ Increase the **Background Compensation** setting (📖 page 42).

Chapter
1

Before Use

Chapter
2

Copy Function

Chapter
3

Submission Function

Chapter
4

Preset Functions

Chapter
5

Scan Function

Chapter
6

Troubleshooting

Q. Thin or broken lines or dots appear on the printout's background part.

A. The Background Compensation setting is too low.

➔ Increase the Background Compensation setting (📖 page 42).

A. The Sharpness setting is too high.

➔ Lower the Sharpness level (📖 page 44).

Q. The printout shows Moire.

A. When the image is processed, regular halftone dots and lines overlap and generate moire.

➔ Try changing the loading direction of the original.

➔ Lower the Sharpness level (📖 page 44).

➔ Try changing **Original Type** to **Text/Photo** (📖 page 31).

Q. A blueprint original is copied or scanned overall with extremely high density.

A. The image quality setting for the blueprint original is slightly higher.

➔ Increase the **Background Compensation** setting (📖 page 42).

Q. A blueprint original is copied or scanned overall with extremely low density.

A. The image quality setting for the blueprint original is slightly lower than required.

➔ Decrease the Density setting. (📖 page 32).

Q. The background of the blueprint original appears on the scanned image or copy printout.

A. The image quality setting for the blueprint original is slightly higher than required.

- ➔ Finetune **Background Compensation** and **Density** settings.
(**Background Compensation**  page 42) (**Density**  page 32)

Q. Characters or lines on the blueprint original do not appear on the scan or copy printout.

A. The image quality setting for the blueprint original is slightly lower than required.

- ➔ Finetune **Background Compensation** and **Density** settings.
(**Background Compensation**  page 42) (**Density**  page 32)
- ➔ If the Original Density Disparity was set to Large during copying or scanning, change it to Small.

Cannot Copy or Scan as Expected

Chapter
1

Before Use

Chapter
2

Copy Function

Chapter
3

Submission Function

Chapter
4

Preset Functions

Chapter
5

Scan Function

Chapter
6

Troubleshooting

Q. Cannot copy or scan because the original is jammed.

A. Originals with folds or a significant curl may cause a paper jam.

- ➔ Try changing the loading direction of the original.
- ➔ Try scanning or copying with a carrier sheet.

Q. The Printer does not detect the roll width or original width properly.

A. At Available Size Standards of the system menu, set the size standard settings you do not use to Off.

Automatic detection may be performed properly when the size standard settings you do not use to Off at Available Size Standards of the system menu.

- ➔ Some improper automatic detections are corrected when the number of the available size standards is reduced.

A. Change the settings of Original Size Standard and Roll Size Standard from Auto to the size standard or roll size standard applied to the original. Some combinations of the original and roll paper may deactivate the Printer's automatic detection.

- ➔ Some combinations of the original and roll paper may deactivate the Printer's automatic detection.

Q. In the original's horizontal direction, a blank space is added to the copy printout; or The right and left edges of the original do not appear on the copy printout; or The size standard of the roll on which the Printer prints is different from the original's one, when the paper is selected and supplied automatically by the Printer.

A. For the original and the printed paper, the size standards are not specified correctly.

- ➔ For copying, the size standards for the original and printed paper must be specified.

- ➔ For more on setting the printing paper series, see **Installing Paper with Other Size Series** in **Chapter 2** of the separate *User's Manual for Basic Printer Operation*.
- ➔ For more on Installing user defined series paper, see **Installing Paper from a User Defined Standard** in **Chapter 2** of the separate *User's Manual for Basic Printer Operation*.
- ➔ For the original's setting, specify the size standard of the original you intend to copy at the copy function's Original Size Standard. (📖 page 38).

Q. With a user defined size original,
 - The Printer does not copy the right and left edges of the original; or
 - The Printer adds a blank space to the right and left edges to the copy printout.

A. The user defined size is incorrect.
 ➔ Refer to **Using Paper from a User Defined Series** in **Chapter 2** of the separate *User's Manual for Basic Printer Operation*. Specify a user defined size appropriate for the original and roll paper you intend to use.

A. The user defined series original width does not match the user defined series roll width.
 ➔ Match the user defined series original width with the user defined series roll width. The Printer does not copy correctly when the widths are different, for example:
 - The original width to 914 mm (35.98 inches); and
 - The roll width: to 880 mm (34.65 inches)

Q. Cannot perform partial copying.

A. - The distance specified below is longer than the original length.
 From: Original's front end
 To: Partial copy start position
 ➔ For partial copying, specify the partial copy start position to be less than

the original length.

- ➔ For example, against the settings below to partially copy an A3 portrait original, the Printer generates a warning message:
 - Partial copy start position to 1000 mm (39.37 inches); or
 - Partial copy start position to 100 mm (3.94 inches) against the original length to 10000 mm (393.70 inches)

A. The distance specified below is longer than the original length.

From: Original's front end

To: Partial copy start position

- ➔ Specify the distance above so that it does not exceed the maximum scannable length.

Q. Cannot erase the frame. Or, the frame is not erased as expected.

A. Frame suppression is affected by the scale setting.

- ➔ On erasing the frame with the scale activated, the frame suppression amount is affected by the scale setting.
Specify the frame suppression amount, considering that the amount is scaled up/down according to the scale setting.

Q. Cannot add blank space. Or, blank space is not added as expected.

A. The **Original Size** is set to **Auto, Portrait, or Landscape**.

- ➔ When **Original Size** is set to **Auto, Portrait, or Landscape**, adding blank space is disabled.
Set **Original Size** to **Synchro Scan**.

A. This is not affected by the scale setting.

- ➔ When adding blank space, the scale setting does not affect the amount of added blank space. Set the amount of blank space without taking the scale setting into account.

Q. When copying a long original, an original jam occurred when outputting the original.

A. This is not a Printer malfunction.

- ➔ Remove the jammed original by following the message displayed on the panel. The Printer can then be used as normal.

Q. The right and left edges of the original are not scanned.

A. The original's size standard is not specified correctly.

- ➔ Set the submission function's **Original Size Standard** to the size standard of the original you intend to load (📖 page 38).

To specify the original's size standard you have never specified, set the size standard to On in Available Size Standard of the System menu. (For more details, see **Chapter 3** in the separate *User's Manual for Basic Printer Operation*.)

Q. When a user defined series original is scanned, the right and left edges of the original are not scanned.

A. The user defined size is not specified correctly.

- ➔ Set a user defined size appropriate for the original in **User Defined Size** of the System menu. (For more details, see **Chapter 3** in the separate *User's Manual for Basic Printer Operation*.)

Q. Cannot perform scanning in color.

A. Color scanning is an optional function (Color Scan Upgrade (LP-857)).

- ➔ Color scanning is only available after purchasing the Color Scan Upgrade.

Q. While scanning, the Printer frequently suspends feeding the original document.

A. When the room temperature is low, on the hard disk drive to save the scan images the operation speed may decrease.

- ➔ Check that the room temperature is within the range from 15°C to 35°C (59 to 95°F). If not, you are recommended to increase the room temperature to be within the range from 20°C to 30°C (68 to 86°F).

Improper Submission

If an error message appears, take the action described in **Chapter 5 Troubleshooting** of the separate *User's Manual for Basic Printer Operation*.

Q. The scanned image is not submitted to the destination.

A. Date and time settings are not correct.

- ➔ Correct the date and time settings. When the date and time settings are not correct, the data submission may be disabled.

A. At the destination settings, the user name and/or password is not correct.

- ➔ On the Add or Edit Image Destination screen, enter the correct user name and/or password.

A. The submission destination's IP address/NetBIOS name settings are not correct. Note that the NetBIOS name is specified only when the destination is computer.

- ➔ On the **Add or Edit Image Destination** screen, set the correct IP address or NetBIOS name.

A. With a NetBIOS name, no data is submit to another network outside the router.

- ➔ On the **Add or Edit Image Destination** screen, submit data with an IP address. Check that the Printer's routing table is specified correctly.

A. The shared path name is not specified correctly.

- ➔ On the **Add or Edit Image Destination** screen, specify a shared path name correctly. To submit to subfolders in the shared folders, be sure to specify the path from the shared folders.