

**ES3640e MFP**

**EFI Job Management Guide**



**59376801**

# Copyright

ES3640e MFP EFI Job Management Guide

P/N 59376801, Revision 1.0

June, 2005

Every effort has been made to ensure that the information in this document is complete, accurate, and up-to-date. Oki assumes no responsibility for the results of errors beyond its control. Oki also cannot guarantee that changes in software and equipment made by other manufacturers and referred to in this guide will not affect the applicability of the information in it. Mention of software products manufactured by other companies does not necessarily constitute endorsement by Oki.

While all reasonable efforts have been made to make this document as accurate and helpful as possible, we make no warranty of any kind, expressed or implied, as to the accuracy or completeness of the information contained herein.

**The most up-to-date drivers and manuals are available from the Oki web site:  
<http://my.okidata.com>**

Copyright © 2005 Oki Data Americas, Inc., and Electronics for Imaging, Inc. All rights reserved.

This publication is protected by copyright, and all rights are reserved. No part of it may be reproduced or transmitted in any form or by any means for any purpose without express prior written consent from Electronics for Imaging, Inc. Information in this document is subject to change without notice and does not represent a commitment on the part of Electronics for Imaging, Inc.

This publication is provided in conjunction with an EFI product (the "Product") which contains EFI software (the "Software"). The Software is furnished under license and may only be used or copied in accordance with the terms of the Software license set forth below.

This product may be covered by one or more of the following U.S. Patents: p 4,716,978, 4,828,056, 4,917,488, 4,941,038, 5,109,241, 5,170,182, 5,212,546, 5,260,878, 5,276,490, 5,278,599, 5,335,040, 5,343,311, 5,398,107, 5,424,754, 5,442,429, 5,459,560, 5,467,446, 5,506,946, 5,517,334, 5,537,516, 5,543,940, 5,553,200, 5,563,689, 5,565,960, 5,583,623, 5,596,416, 5,615,314, 5,619,624, 5,625,712, 5,640,228, 5,666,436, 5,745,657, 5,760,913, 5,799,232, 5,818,645, 5,835,788, 5,859,711, 5,867,179, 5,940,186, 5,959,867, 5,970,174, 5,982,937, 5,995,724, 6,002,795, 6,025,922, 6,035,103, 6,041,200, 6,065,041, 6,112,665, 6,116,707, 6,122,407, 6,134,018, 6,141,120, 6,166,821, 6,173,286, 6,185,335, 6,201,614, 6,215,562, 6,219,155, 6,219,659, 6,222,641, 6,224,048, 6,225,974, 6,226,419, 6,238,105, 6,239,895, 6,256,108, 6,269,190, 6,271,937, 6,278,901, 6,279,009, 6,289,122, 6,292,270, 6,299,063, 6,310,697, 6,321,133, 6,327,047, 6,327,050, 6,327,052, 6,330,071, 6,330,363, 6,331,899, 6,340,975, 6,341,017, 6,341,018, 6,341,307, 6,347,256, 6,348,978, 6,356,359, 6,366,918, 6,369,895, 6,381,036, 6,400,443, 6,429,949, 6,449,393, 6,476,927, 6,490,696, 6,501,565, 6,519,053, 6,539,323, 6,543,871, 6,546,364, 6,549,294, 6,549,300, 6,550,991, 6,552,815, 6,559,958, 6,572,293, 6,590,676, 6,606,165, 6,633,396, 6,636,326, 6,643,317, 6,647,149, 6,657,741, 6,662,199, 6,678,068, RE33,973, RE36,947, D341,131, D406,117, D416,550, D417,864, D419,185, D426,206, D439,851, D444,793.

### Trademarks

Auto-Count, ColorCal, ColorWise, Command WorkStation, EDOX, EFI, Fiery, the Fiery logo, MicroPress, Printcafe, PrinterSite, Prograph, Proteus, and Spot-On are registered trademarks of Electronics for Imaging, Inc., in the U.S. Patent and Trademark Office and/or certain other foreign jurisdictions. Bestcolor is a registered trademark of Best GmbH in the U.S. Patent and Trademark Office.

AutoCal, Digital StoreFront, DocStream, Fiery Link, FreeForm, Hagen, Intelligent Device Management, Logic, OneFlow, PrintFlow, PrintMe, PrintSmith Site, PrintSmith, PSI Flexo, PSI, SendMe, Splash, VisualCal, the EFI logo, Essential to Print are trademarks of Electronics for Imaging, Inc. Best, the Best logo, Colorproof, PhotoXposure, Remoteproof, and Screenproof are trademarks of Best GmbH

OKI is a registered trademark of OKI Electric Industries Co., Ltd. Oki Data is a registered trademark of Oki Americas, Inc.

All other terms and product names may be trademarks or registered trademarks of their respective owners, and are hereby acknowledged.

#### Legal Notices

APPLE COMPUTER, INC. ("APPLE") MAKES NO WARRANTIES, EXPRESS OR IMPLIED, INCLUDING WITHOUT LIMITATION THE IMPLIED WARRANTIES OF MERCHANTABILITY AND FITNESS FOR A PARTICULAR PURPOSE, REGARDING THE APPLE SOFTWARE. APPLE DOES NOT WARRANT, GUARANTEE, OR MAKE ANY REPRESENTATIONS REGARDING THE USE OR THE RESULTS OF THE USE OF THE APPLE SOFTWARE IN TERMS OF ITS CORRECTNESS, ACCURACY, RELIABILITY, CURRENTNESS, OR OTHERWISE. THE ENTIRE RISK AS TO THE RESULTS AND PERFORMANCE OF THE APPLE SOFTWARE IS ASSUMED BY YOU. THE EXCLUSION OF IMPLIED WARRANTIES IS NOT PERMITTED BY SOME STATES. THE ABOVE EXCLUSION MAY NOT APPLY TO YOU.

IN NO EVENT WILL APPLE, ITS DIRECTORS, OFFICERS, EMPLOYEES OR AGENTS BE LIABLE TO YOU FOR ANY CONSEQUENTIAL, INCIDENTAL OR INDIRECT DAMAGES (INCLUDING DAMAGES FOR LOSS OF BUSINESS PROFITS, BUSINESS INTERRUPTION, LOSS OF BUSINESS INFORMATION, AND THE LIKE) ARISING OUT OF THE USE OR INABILITY TO USE THE APPLE SOFTWARE EVEN IF APPLE HAS BEEN ADVISED OF THE POSSIBILITY OF SUCH DAMAGES. BECAUSE SOME STATES DO NOT ALLOW THE EXCLUSION OR LIMITATION OF LIABILITY FOR CONSEQUENTIAL OR INCIDENTAL DAMAGES, THE ABOVE LIMITATIONS MAY NOT APPLY TO YOU. Apple's liability to you for actual damages from any cause whatsoever, and regardless of the form of the action (whether in contract, tort [including negligence], product liability or otherwise), will be limited to \$50.

PANTONE® Colors displayed in the software application or in the user documentation may not match PANTONE-identified standards. Consult current PANTONE Color Publications for accurate color. PANTONE® and other Pantone, Inc. trademarks are the property of Pantone, Inc. © Pantone, Inc., 2001.

Pantone, Inc. is the copyright owner of color data and/or software which are licensed to Electronics for Imaging, Inc., to distribute for use only in combination with the products, or software of Electronics for Imaging, Inc. PANTONE Color Data and/or Software shall not be copied onto another disk or into memory except as part of the delivery of the Electronics for Imaging, Inc., products or software.

This product includes software developed by the Apache Software Foundation (<http://www.apache.org/>).

#### FCC Information

WARNING: FCC Regulations state that any unauthorized changes or modifications to this equipment not expressly approved by the manufacturer could void the user's authority to operate this equipment.

#### Class B Declaration of Conformity

This equipment has been tested and found to comply with the limits for a class B digital device, pursuant to Part 15 of the FCC rules. These limits are designed to provide reasonable protection against harmful interference in a residential installation. This equipment generates, uses and can radiate radio frequency energy and if not installed and used in accordance with the instructions, may cause harmful interference to radio communications. However, there is no guarantee that interference will not occur in a particular installation.

If this equipment does cause harmful interference to radio or television reception, which can be determined by turning the equipment off and on, the user is encouraged to try to correct the interference by one or more of the following measures:

Reorient or relocate the receiving antenna.

Increase the separation between the equipment and receiver.

Connect the equipment into an outlet on a circuit different from that to which the receiver is connected.

Consult the dealer or an experienced radio/TV technician for help.

## 4 Copyright

In order to maintain compliance with FCC regulations, shielded cables must be used with this equipment. Operation with non-approved equipment or unshielded cables is likely to result in interference to radio and TV reception. The user is cautioned that changes and modifications made to the equipment without the approval of manufacturer could void the user's authority to operate this equipment.

### Industry Canada Class B Notice

This Class B digital apparatus complies with Canadian ICES-003.

Avis de Conformation Classe B de l'Industrie Canada

Cet appareil numérique de la Classe B est conforme à la norme NMB-003 du Canada.

### RFI Compliance Notice

This equipment has been tested concerning compliance with the relevant RFI protection requirements both individually and on system level (to simulate normal operation conditions). However, it is possible that these RFI Requirements are not met under certain unfavorable conditions in other installations. It is the user who is responsible for compliance of his particular installation.

Dieses Gerät wurde sowohl einzeln als auch in einer Anlage, die einen normalen Anwendungsfall nachbildet, auf die Einhaltung der Funkentstörbestimmungen geprüft. Es ist jedoch möglich, dass die Funkentstörbestimmungen unter ungünstigen Umständen bei anderen Gerätekombinationen nicht eingehalten werden. Für die Einhaltung der Funkentstörbestimmungen einer gesamten Anlage, in der dieses Gerät betrieben wird, ist der Betreiber verantwortlich.

Compliance with applicable regulations depends on the use of shielded cables. It is the user who is responsible for procuring the appropriate cables.

Die Einhaltung zutreffender Bestimmungen hängt davon ab, dass geschirmte Ausführungen benützt werden. Für die Beschaffung richtiger Ausführungen ist der Betreiber verantwortlich.

### Software License Agreement

YOU SHOULD CAREFULLY READ THE FOLLOWING TERMS AND CONDITIONS BEFORE USING THIS SOFTWARE. IF YOU DO NOT AGREE TO THE TERMS AND CONDITIONS OF THIS AGREEMENT, DO NOT USE THE SOFTWARE. INSTALLING OR USING THE SOFTWARE INDICATES THAT YOU AGREE TO AND ACCEPT THE TERMS OF THIS AGREEMENT. IF YOU DO NOT AGREE TO ACCEPT THE TERMS OF THIS AGREEMENT YOU MAY RETURN THE UNUSED SOFTWARE FOR A FULL REFUND TO THE PLACE OF PURCHASE.

### License

EFI grants you a non-exclusive license to use the Software and accompanying documentation ("Documentation") included with the Product. The Software is licensed, not sold. You may use the Software solely for your own customary business or personal purposes. You may not rent, lease, sublicense or lend the Software or use the Software in any time sharing, service bureau, or similar arrangement.

You may not make or have made, or permit to be made, any copies of the Software or portions thereof, except one (1) copy for backup or archive purposes in support of your use of the Software as permitted hereunder. You may not copy the Documentation. You may not attempt to localize, translate, disassemble, decompile, decrypt, reverse engineer, discover the source code of, modify, create derivative works of, or in any way change any part of the Software.

The terms, conditions, and restrictions in the License Agreement apply to all bug fixes, patches, releases, release notes, updates, and upgrades related to the Software.

### Proprietary Rights

You acknowledge and agree that all rights, title and interest, including all intellectual property rights, in and relating to the Software, Documentation and all modifications and derivative works thereof are solely owned by and shall remain with EFI and

## 5 Copyright

its suppliers. Except for the express limited license granted above to use the Software, no right or license of any kind is granted. You receive no rights or license under any patents, copyrights, trade secrets, or trademarks (whether registered or unregistered). You agree not to adopt, register, or attempt to register any EFI trademark or trade name ("EFI Mark") or any confusingly similar mark, URL, internet domain name, or symbol as your own name or the name of your affiliates or products, and not to take any other action which impairs or reduces the trademark rights of EFI or its suppliers.

### Confidentiality

The Software is confidential, proprietary information of EFI and you may not distribute or disclose the Software. You may, however, permanently transfer all of your rights under this Agreement to another person or legal entity provided that: (1) such a transfer is authorized under all applicable export laws and regulations, including the U.S. Export Administration Regulations, (2) you transfer to the person or entity all of the Software and Documentation (including all copies, updates, upgrades, prior versions, component parts, the media and printed materials, and this Agreement); (3) you retain no copies of the Software and Documentation, including copies stored on a computer; and (4) the recipient agrees to the terms and conditions of this Agreement.

### Remedies and Termination

Unauthorized use, copying, or disclosure of the Software, or any breach of this Agreement will result in automatic termination of this license and will make available to EFI other legal remedies. In the event of termination, you must destroy all copies of the Software, Documentation, and all component parts thereof. All provisions of this Agreement relating to disclaimers of warranties, limitation of liability, remedies, damages, governing law, jurisdiction, venue, and EFI's proprietary rights shall survive termination.

### Limited Warranty and Disclaimer

EFI warrants to the original purchaser ("Customer") for thirty (30) days from the date of original purchase from EFI or its authorized retailer that the Software will perform in substantial conformance to the Documentation when the Product is used as authorized by EFI's specifications. EFI warrants the media containing the Software against failure during the above warranty period. EFI makes no warranty or representation that the Software will meet your specific requirements, that the operation of the Software will be uninterrupted, secure, fault-tolerant, or error free, or that all defects in the Software will be corrected. EFI makes no warranty, implied or otherwise, regarding the performance or reliability of any third party products (software or hardware). THE INSTALLATION OF ANY THIRD PARTY PRODUCTS OTHER THAN AS AUTHORIZED BY EFI WILL VOID THIS WARRANTY. IN ADDITION, USE, MODIFICATION, AND/OR REPAIR OF THE PRODUCT OTHER THAN AS AUTHORIZED BY EFI WILL VOID THIS WARRANTY.

EXCEPT FOR THE ABOVE EXPRESS LIMITED WARRANTY AND TO THE MAXIMUM EXTENT PERMITTED BY APPLICABLE LAW, EFI MAKES AND YOU RECEIVE NO WARRANTIES OR CONDITIONS ON THE SOFTWARE, EXPRESS, IMPLIED, STATUTORY, OR IN ANY OTHER PROVISION OF THIS AGREEMENT OR COMMUNICATION WITH YOU, AND EFI SPECIFICALLY DISCLAIMS ANY IMPLIED WARRANTY OR CONDITION OF MERCHANTABILITY OR FITNESS FOR A PARTICULAR PURPOSE OR NONINFRINGEMENT OF THIRD PARTY RIGHTS.

### Limitation of Liability

TO THE MAXIMUM EXTENT PERMITTED BY LAW, EFI AND ITS SUPPLIERS SHALL NOT BE LIABLE FOR ANY DAMAGES, INCLUDING LOSS OF DATA, LOST PROFITS, COST OF COVER OR OTHER SPECIAL, INCIDENTAL, CONSEQUENTIAL OR INDIRECT DAMAGES ARISING FROM THE SALE, INSTALLATION, MAINTENANCE, USE, PERFORMANCE OR FAILURE OF THE SOFTWARE, HOWEVER CAUSED AND ON ANY THEORY OF LIABILITY. THIS LIMITATION WILL APPLY EVEN IF EFI HAS BEEN ADVISED OF THE POSSIBILITY OF SUCH DAMAGE. YOU ACKNOWLEDGE THAT THE PRICE OF THE PRODUCT REFLECTS THIS ALLOCATION OF RISK. BECAUSE SOME JURISDICTIONS DO NOT ALLOW THE EXCLUSION OR LIMITATION OF LIABILITY FOR CONSEQUENTIAL OR INCIDENTAL DAMAGES, THE ABOVE LIMITATION MAY NOT APPLY TO YOU.

## 6 Copyright

You are hereby notified that Adobe Systems Incorporated, a Delaware corporation located at 345 Park Avenue, San Jose, CA 95110-2704 ("Adobe") is a third-party beneficiary to this agreement to the extent that this agreement contains provisions which relate to your use of any software, font programs, typefaces, and/or trademarks licensed or supplied by Adobe. Such provisions are made expressly for the benefit of Adobe and are enforceable by Adobe in addition to EFI. ADOBE WILL HAVE NO LIABILITY WHATSOEVER TO YOU FOR ANY ADOBE SOFTWARE OR TECHNOLOGY LICENSED HEREUNDER.

### Export Controls

EFI's Products are subject to U.S. export laws and regulations, including the U.S. Export Administration Regulations, as well as foreign export laws and regulations. You agree that you will not use, distribute, transfer, export, or re-export any portion of the Product or the Software in any form in violation of any applicable laws or regulations of the United States or the country in which you obtained them.

### U.S. Government Restricted Rights:

Use, duplication, or disclosure of the Software by the United States Government is subject to restrictions as set forth in FAR 12.212 or DFARS 227.7202-3 -227.7202-4 and, to the extent required under U.S. federal law, the minimum restricted rights as set out in FAR 52.227-14, Restricted Rights Notice (June 1987) Alternate III(g)(3)(June 1987) or FAR 52.227-19 (June 1987). To the extent any technical data is provided pursuant to the Agreement, such data is protected per FAR 12.211 and DFARS 227.7102-2 and to the extent explicitly required by the U.S. Government, is subject to limited rights as set out in DFARS 252.227.7015 (November 1995) and DFARS 252.227-7037 (September 1999). In the event that any of the above referenced agency regulations are modified or superceded, the subsequent or equivalent regulation shall apply. The name of the Contractor is Electronics for Imaging.

### General

The rights and obligations of the parties related to this Agreement will be governed in all respects by the laws of the State of California exclusively, as such laws apply to contracts between California residents performed entirely within California. The United Nations Convention on Contracts for the International Sale of Goods and any other similar convention does not apply to this Agreement. For all disputes related to this Agreement, you consent to the personal and exclusive jurisdiction and venue of the state courts in San Mateo County, California and the federal court for the Northern District of California. This Agreement is the entire agreement held between us and supersedes any other communications or advertising with respect to the Software. If any provision of this Agreement is held invalid, such provision shall be deemed modified to the extent necessary to be enforceable and the other provisions in this Agreement shall continue in full force and effect.

If you have any questions, please see EFI's web site at [www.efi.com](http://www.efi.com).

Electronics for Imaging

303 Velocity Way

Foster City, CA 94404

# Contents

## **About the Documentation 12**

## **Introduction 13**

---

About this manual 13

Terminology 14

## **Chapter 1: About Job Management**

---

**Job environments** 1-16

Levels of job control 1-16

Setting up an operator-controlled environment 1-17

---

**Understanding job flow** 1-17

Spooling, processing, and printing 1-18

Visualizing job flow 1-19

---

**Communicating with users** 1-20

What the operator should check 1-21

---

**Overview of the job management utilities** 1-23

Command WorkStation 1-23

Command WorkStation LE 1-23

Fiery Spooler 1-24

## **Chapter 2: Introduction to Command WorkStation and Command WorkStation LE**

---

**The graphical interface** 2-25

Active Jobs window 2-28

Jobs window 2-30

Activity Monitor 2-32

Job status indicators 2-36

Action buttons 2-38

Preview windows 2-38

---

**Monitoring single or multiple Fiery servers\*** 2-38

<b>Customizing the graphical interface</b>	2-39
Using layout styles*	2-39
Showing, hiding, and arranging components	2-40
<b>Using commands</b>	2-42
Menu bar	2-42
Context-sensitive menus	2-50
<b>Preparing to work with Command WorkStation or Command WorkStation LE</b>	2-51
Connecting to the Fiery	2-51
Printing Fiery information pages	2-53
Setting preferences	2-56
Correcting tray alignment*	2-58
Managing Fiery fonts	2-61

## Chapter 3: Using Command WorkStation or Command WorkStation LE

<b>Starting up and logging in</b>	3-65
Logging in to the Fiery	3-66
Access levels	3-68
Logging out	3-70
Removing the Fiery from the server list	3-70
<b>Monitoring jobs</b>	3-71
Selecting jobs	3-71
Sorting job displays	3-72
Customizing job ticket information	3-72
<b>Managing job flow</b>	3-75
Importing jobs	3-75
Using job management commands	3-78
Viewing and overriding print settings	3-80
Reordering jobs*	3-83
Managing jobs on multiple Fiery servers*	3-85
Cancelling jobs	3-86
<b>Defining Mixed Media settings*</b>	3-86
<b>Printing Fiery FreeForm variable data documents</b>	3-89



Creating and monitoring FreeForm masters	3-90
Using FreeForm masters with variable data jobs	3-92
Tips for using Fiery FreeForm	3-93
<b>Archiving jobs</b>	3-94
<b>Using the Job Log</b>	3-96
<b>Searching for jobs</b>	3-97

## Chapter 4: Previewing and Manipulating Jobs

<b>Previewing jobs</b>	4-103
Displaying thumbnail previews	4-103
Preview window controls	4-104
Displaying full-screen previews	4-105
<b>Editing and merging jobs</b>	4-107
Editing jobs	4-107
Merging jobs	4-109

## Chapter 5: Using DocBuilder Pro

<b>Previewing, editing, and merging jobs</b>	5-114
<b>Imposition window</b>	5-117
<b>Job previews</b>	5-118
<b>Navigating in the Imposition window</b>	5-120
Switching between page view and layout view	5-122
Setting magnification levels	5-123
Viewing the sheets	5-125
<b>Using templates</b>	5-126
<b>Saving your work</b>	5-128

## Chapter 6: Advanced Features of DocBuilder Pro

<b>Mixed Page mode and Fixed Page mode</b>	6-129
<b>Imposition settings</b>	6-130
Sheet settings	6-131
Layout settings	6-133

Scale settings	6-137
Finishing settings	6-140
<b>Modifying the layout manually</b>	6-145
Reordering pages in Layout mode	6-145
Adding, duplicating, and deleting sheets	6-146
Editing page content	6-148
Rotating pages	6-149
Setting gutter sizes	6-151
<b>Managing templates</b>	6-152
<b>Tips for using the Imposition feature of DocBuilder Pro</b>	6-154
Page-level operations	6-154
Saving imposed jobs	6-154

## Chapter 7: Fiery WebSpooler and Fiery Spooler

<b>Tracking and managing jobs with Fiery WebSpooler</b>	7-156
About the Fiery WebSpooler window	7-159
Manipulating job options and job flow	7-161
Overriding job option settings	7-163
<b>Job icons</b>	7-164
Spool area	7-165
RIP area	7-166
Print area	7-167
<b>Previewing, editing, and merging jobs</b>	7-167
Previewing raster jobs	7-168
Displaying full-screen previews	7-170
Editing and merging raster files	7-172
Using the Job Log	7-176
<b>Fiery Spooler for Mac OS computers</b>	7-179
Starting Fiery Spooler	7-179
Connecting to a different Fiery from Fiery Spooler	7-180

## Appendix A: Basics of Imposition

---

### Printing books with the Imposition feature of DocBuilder Pro

A-182	
Basics of imposition layout	A-182
Printer's marks	A-185
Additional sheets	A-187
Binding methods	A-189
Gang-Up printing	A-191

## Appendix B: Templates

<b>1-Up Full Bleed</b>	B-194
<b>2-Up Perfect</b>	B-195
<b>2-Up Saddle</b>	B-197
<b>3-Up Trifold Brochure</b>	B-199
<b>4-Up Gate Fold</b>	B-201
<b>4-Up Head to Head</b>	B-203
<b>4-Up Z-Fold</b>	B-205

## Appendix C: Troubleshooting

<b>Error messages</b>	C-207
<b>Troubleshooting</b>	C-208
Command WorkStation or Command WorkStation LE does not respond	C-208
Unexpected printing results	C-209
Clearing the server	C-210
Users are unable to connect to the Fiery	C-210
Setup error messages	C-211

## Index

## 212

## About the Documentation

This manual is part of a set of Fiery documentation that includes the following manuals for users and system administrators. Most are available as Acrobat PDF (Portable Document Format) files on the User Documentation CD.

- The *User Software Installation Guide* describes how to install software from the User Software CD to enable users to print to the Fiery, and also describes setting up printing connections to the Fiery.
- The *Configuration Guide* explains basic configuration and administration of the Fiery for the supported platforms and network environments. It also includes guidelines for setting up UNIX, Windows NT 4.0/2000/Server 2003, and Novell NetWare servers to provide printing services to users.
- The *Printing Guide* describes the printing features of the Fiery for users who send jobs from their computers.
- The *Color Guide* provides information on managing the color output of the Fiery. It explains how to calibrate your Fiery and take advantage of the ColorWise® color management system, as well as features in ColorWise Pro Tools™.
- The *Fiery Color Reference* addresses concepts and issues associated with managing color output of the Fiery and outlines key workflow scenarios. In addition, it offers information on printing color documents from popular Microsoft Windows and Apple Mac OS applications.
- The *Job Management Guide* explains the functions of the job management utilities, including Command WorkStation™, Command WorkStation LE™, and DocBuilder Pro™, and how you can use them to monitor and control jobs on the Fiery. This manual is intended for an operator or administrator, or a user with the necessary access privileges, who monitors and manages job flow, performs color calibration, and troubleshoots problems that may arise.
- *Release Notes* provide last-minute product information and workarounds for some of the problems you may encounter.

## Introduction

This manual is intended for Fiery operators and administrators, or users with the necessary access privileges, who monitor and manage job flow, manipulate jobs, and troubleshoot problems that may arise. It describes the functions and features of the Fiery® job management utilities—Command WorkStation, Command WorkStation LE, and Fiery Spooler™—for the purposes of job management and quality control.

**Note:** In this guide, the term “Fiery” is used to refer to the Fiery Network Controller for ES3640e MFP. The name “Aero” is used in illustrations to represent the Fiery. The term “printer” is also used to refer to the Fiery. The term “Windows” is used to refer to Windows 98, Windows Me, Windows NT 4.0, Windows 2000, Windows XP, and Windows Server 2003, wherever appropriate. Illustrations of Windows software may not necessarily reflect the version of Windows that you use.

## About this manual

This manual is organized as follows:

- [Chapter 1](#) provides preliminary background information about job management and introduces the Fiery job management utilities. It explains how to set up an operator-controlled print environment and discusses job workflows that commonly occur on the Fiery.
- [Chapter 2](#) introduces the Command WorkStation and Command WorkStation LE user interfaces. It also provides information on basic Command WorkStation and Command WorkStation LE functions, such as printing Fiery information pages and setting preferences.
- [Chapter 3](#) provides instructions on how to monitor and manage job flow using Command WorkStation and Command WorkStation LE. It explains how to hold, process, print, and cancel selected jobs, and how to track and archive printed jobs.

- [Chapter 4](#) describes how to preview, edit, and merge jobs using the Preview windows of Command WorkStation and Command WorkStation LE.
- [Chapter 5](#) describes how to use the Imposition feature of DocBuilder Pro to arrange the pages of your print job in special layouts for folding, binding, or cutting after printing. The Imposition feature is available only if you have installed the DocBuilder Pro option for Command WorkStation.
- [Chapter 6](#) provides instructions on using advanced aspects of DocBuilder Pro to create custom layouts and take full advantage of Imposition features.
- [Chapter 7](#) describes Fiery Spooler, which you can use to view and manage Fiery job activity.
- [Appendix A](#) provides an overview of the terms and concepts of imposition, including various folding, binding, and cutting methods.
- [Appendix B](#) describes the built-in templates available from the Imposition feature of DocBuilder Pro.
- [Appendix C](#) provides basic troubleshooting information.

## Terminology

Specific terms are explained as they are introduced. However, the following general terms are used throughout:

- **PostScript (PS)**—A computer language designed as a page description language. The Fiery uses this language to image the page and communicate with applications.

The term “PostScript” can also be used to refer to PDF data jobs. PDF is a structured form of PostScript that provides the ability to preview, scale, and reorder pages. Where applicable, the term “PDF” is specifically used to refer to PDF data or jobs.

- **Printer Control Language (PCL)**—A computer language designed as a page description language. The Fiery also uses this language to image the page, and communicate with applications.
- **Job**—A file consisting of PostScript or PCL commands and comments that describe the graphics, sampled images, and text that should appear on each page of a document, and the printer options that should be used in printing, such as media or finishing options.
- **Spool**—Write to a disk. Used in this manual to refer to a PostScript or PCL print job saved to the Fiery hard disk drive in preparation for processing and printing.
- **RIP**—Acronym for raster image processing, which changes PostScript or PCL commands into descriptions of each mark on a page. In common use as a noun, a “raster image processor” (RIP) is the computer processor that performs this function.  
  
The Fiery RIP changes text and graphics commands in PostScript or PCL into specifications for each dot of toner deposited on a page by the printer.
- **Process**—The term “process” is used interchangeably with the term “RIP” in this manual to refer to raster image processing.
- **Print**—The task of rendering, or imaging, a page or job on a print device.

These concepts explain how the Fiery works as a powerful printing system.

## Chapter 1: About Job Management

This chapter explains the basic principles of job management in an operator-controlled print environment and provides an overview of the Fiery job management utilities.

### Job environments

The Fiery supports several control levels of printing, job management, and Setup, and gives you the flexibility to choose a configuration that corresponds to the requirements of your site.

### Levels of job control

The following descriptions outline the range of levels of job control that may exist in your environment:

- At one extreme, an *operator* in a high-volume printing environment controls the entire job flow and all printing. Print jobs arriving from remote users are spooled to the Fiery hard disk drive and stored until the operator decides it is time to print them. Additional functions (job overrides, prioritizing, and font management) are reserved for the *operator*.
- At the other extreme, *anyone* on the local network can control all printing and Fiery functions; operator intervention is not required. Users can print from their workstations to any of the published print connections. *Anyone* can use the job management utilities to control any print job.

You can implement intermediate levels of job control in your environment. However, the job management utilities are best suited for an operator-controlled environment.



## Setting up an operator-controlled environment

This manual assumes you are working in an operator-controlled environment with responsibility for managing job flow. To establish an operator-controlled environment, you or the *administrator* must complete the following tasks:

**Set up password privileges**—The administrator must set up separate passwords for *operator* access and *administrator* access to the Fiery. For instructions on setting up passwords, see the [Configuration Guide Chapter 7](#).

**Publish the Hold queue only**—The *administrator* must enable only the Hold queue, not the Direct connection or the Print queue, in Setup. (For more information, see the [Configuration Guide Chapter 3](#).) This ensures that all jobs sent by *remote users* are spooled and held on the Fiery, in preparation for job management by the *operator*.

**Establish communication between users and the operator**—The *operator* and *remote users* must agree on a method for communicating print needs, such as Fiery FreeForm™ masters. Users can attach instructions to jobs using print option and notes fields (see [page 1-5](#)).

## Understanding job flow

In an operator-controlled printing environment, remote users send jobs to the Hold queue of the Fiery. Using a job management utility, the operator views the list of held jobs and decides when to release each job for processing and printing.

The operator may also intervene during the workflow, stopping jobs as they are processed or printed, placing jobs on hold for future action, or overriding the user-defined print settings for a job. In some cases, the operator may even modify a job, duplicating or removing pages, or merging it with pages from another job before releasing it for printing.

## Spooling, processing, and printing

### Spooling

To understand job flow through the Fiery, it is helpful to consider the three main stages of printing.



### Processing

**Spooling**—When a job file is sent over the network by a remote user or imported from disk, it arrives at the Fiery and spools to a location on the hard disk drive. After spooling completely, the job is held on the hard disk drive, where it awaits further instructions from the operator.



### Printing

**Processing (RIPping)**—When the operator releases the job file, it undergoes raster image processing (RIPping) at the Fiery. During processing, the job file is interpreted as a raster image. This raster image contains the data required by the printer to print the job the way its originator intended. In the raster image, data associated with each dot is rendered on the printer. The raster data tells the printer whether or not to apply toner to each position on the page.

**Printing**—After processing, the job typically moves on to the printing stage. During this stage, the raster image associated with the job is rendered onto paper, and the job is printed.

While original job files are saved to the Fiery hard disk drive, raster images are typically deleted after printing. The operator can issue commands to save and hold the raster image on the hard disk drive along with the original job file. Saving the raster image to the hard disk drive offers two advantages: raster files are already processed, so they print quickly, and each part of the raster file is still identified with a page in the original document, so you can access individual pages of a saved raster file.

# 1

## Visualizing job flow

As the operator, your job management tools permit *holding* and *releasing* a job at any stage of the job flow. In the following illustration, solid boxes indicate the types of job status flags you may see in the Command WorkStation or Command WorkStation LE Active Jobs window. Boldface items represent commands you can issue from a job management utility to release held jobs.

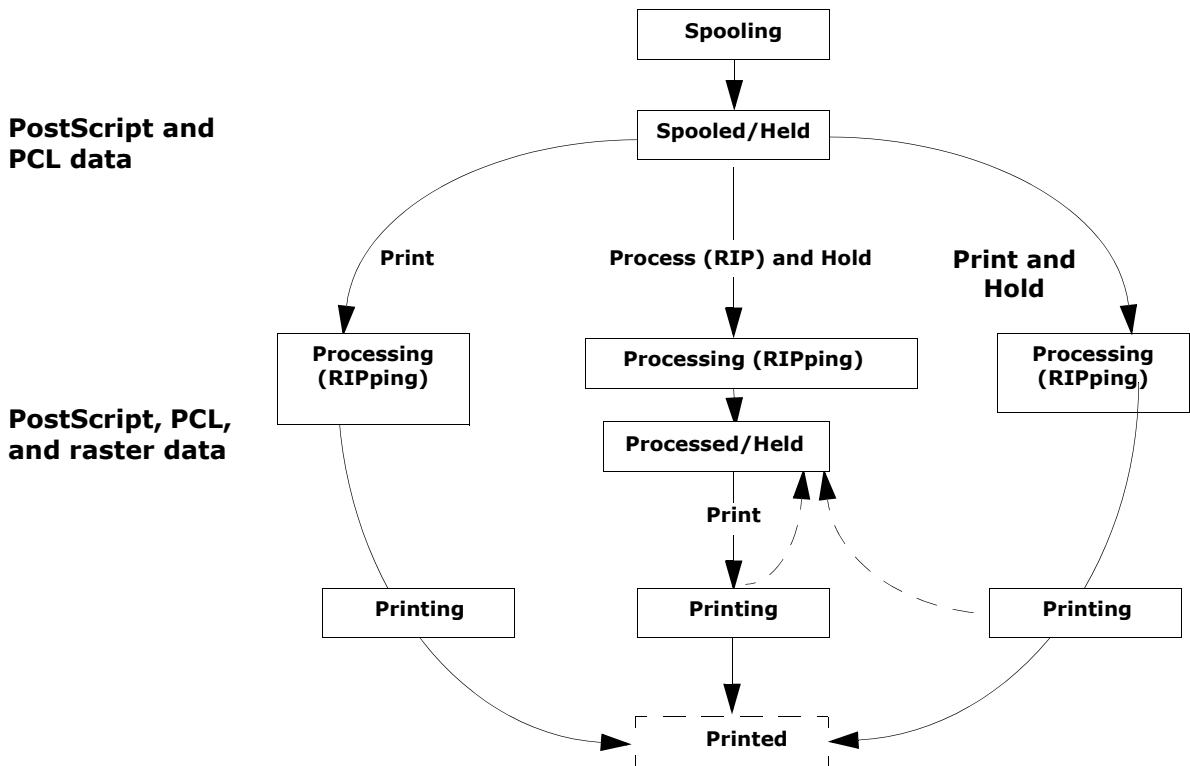

Each command initiates a job workflow:

**Print**—When you issue the Print command for a held job, the job is released for immediate processing and printing on the printer.

**Print and Hold**—When you issue the Print and Hold command for a held job, the job is released for immediate processing and printing. However, a raster copy of the original job remains in processed/held status, even after the original job finishes printing.

**Process (RIP) and Hold**—When you issue the Process and Hold command (Command WorkStation or Command WorkStation LE) or RIP and Hold command (Fiery Spooler) for a held job, the job is released for processing and then held in processed/held status indefinitely. To release the job for immediate printing, you must issue the Print command. A raster copy of the original job remains in processed/held status, even after the original job has finished printing.

## Communicating with users

As the operator, you can use the job management tools to communicate with users who originate print jobs. You can help users become better informed about the Fiery so that they can choose the appropriate options for their jobs by supplying the following information:

### Fiery device information

- The name of the Fiery on the network and the names of the network servers sharing it
- The IP address or DNS name of the Fiery, to allow users access to Fiery WebTools™
- List of default Fiery settings and other settings
- List of installed fonts

If their applications do not download fonts automatically, can users download fonts to the Fiery? Should users embed fonts in documents or supply them for you to download?

- Resident calibration target and date of current measurements
- Custom simulations

Are custom simulations available? If so, what type of targets do they represent? Although users see these print options, they should not select them if there are no custom targets on the Fiery.

- List of installable options for the Fiery
- Available media, alternative choices, and standard tray/media configurations

### **Printing information**

- Duration for jobs to be held on the Fiery before deletion
- Instructions for setting up the printer on client computers
- Sources of PostScript printer drivers, PPDs, color reference files, and additional information
- Recommended PPD settings
- Conflicting settings and common PostScript errors
- FreeForm information regarding use of master and variable data
- Imposition information regarding use of the DocBuilder Pro option
- Characteristics of commonly used output color profiles
- Requirements for Notes fields (information that appears in the Job Log)

For example, department name, account code, phone number, or extension. Is particular information mandatory at your site?

- Suggestions for what to enter in the Instructions field

### **What the operator should check**

Users specify print options with jobs they send to the printer. They can also use the Instructions and Notes fields to communicate special print requirements and accounting information. Together, this user-specified information that accompanies the job is called a job ticket.

As the operator, we recommend that you tell remote users which job ticket information *you* check when receiving a print job, and the information you require in order to print jobs they send.

### **Job ticket information**

You can view and potentially override the print options specified by users by checking job ticket information. To display user-defined print options, choose Properties in Command WorkStation or Command WorkStation LE ([see 3–80](#)), or Override Print Settings in Fiery Spooler ([see 7–163](#)).

### **Notes fields**

Users can enter accounting information in the Notes fields, such as:

- User name and phone number
- Billing information
- Job cost information

### **Instructions field**

Users can also enter information in the Instructions field to communicate special print requirements, such as:

- Priority, due date, and request for notification
- Number of copies
- Type and quantity of paper
- Request for color check by the operator
- Request to hold job for future printing or reprinting, and future job instructions
- Instructions to merge job with another job
- Fiery FreeForm information regarding the use of master and variable data
- Imposition instructions

## Overview of the job management utilities

The Fiery includes the following job management utilities:

- Command WorkStation
- Command WorkStation LE (Mac OS X)
- Fiery Spooler (Mac OS 9.x)

These utilities are designed for use by operators who must track and manage jobs and oversee general job flow through the Fiery. All the utilities offer the following job management features:

- Monitoring activity on the Fiery and controlling job flow
- Viewing and overriding user-defined print option settings
- Editing and merging job files
- Tracking job activity through the Job Log

### Command WorkStation

The most powerful of the job management utilities, Command WorkStation can be installed on a Microsoft Windows computer that has a network connection to the Fiery. In addition to the job management functions previously outlined, Command WorkStation offers a customizable user interface for monitoring and managing jobs on multiple Fiery servers simultaneously.

For an introduction to the Command WorkStation user interface, see [Chapter 2](#). For information on monitoring, managing, and archiving jobs with Command WorkStation, see [Chapter 3](#).

### Command WorkStation LE

Command WorkStation LE allows operators and users to manage jobs from a Mac OS X computer with a network connection to the Fiery.

# 1

## 1-24 About Job Management

The features of Command WorkStation LE are similar to those of Command WorkStation. For information on Command WorkStation LE, see Chapters 2 and 3.

### Fiery Spooler

Fiery Spooler must be installed on a networked Mac OS 9.x computer and can only be used on that computer.

Fiery Spooler offers job management functions similar to those of Command WorkStation. The default Fiery Spooler user interface is shown in the following illustration.

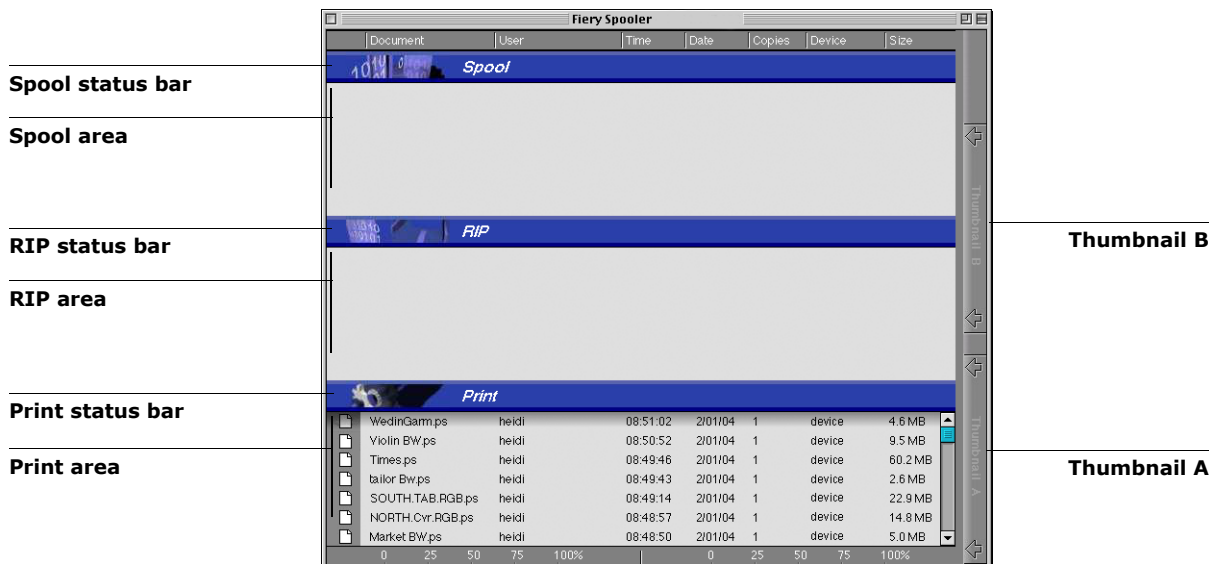

For more information about using Fiery Spooler, see [Chapter 7](#).



## Chapter 2: Introduction to Command WorkStation and Command WorkStation LE

This chapter provides an introduction to the Command WorkStation and Command WorkStation LE graphical user interfaces. To follow along in the software as you read the chapter, log in to the application with an Operator or Administrator password, as described on [page 3-66](#).

Once you are logged in, you can tour the application. Your exploration will be more complete if you have some jobs in the Active Jobs window (jobs in the Hold queue), and can send more jobs from a nearby computer.

The chapter also describes Setup functions such as printing Fiery information pages, setting application preferences, and managing Fiery fonts.

**Note:** Unless otherwise specified, information in this chapter applies to both Command WorkStation and Command WorkStation LE. Sections that apply exclusively to Command WorkStation are denoted by an asterisk (\*). Sections that apply exclusively to Command WorkStation LE are denoted by a dagger (†). In cases where the two applications are nearly identical, only Command WorkStation illustrations are shown.

### The graphical interface

Command WorkStation and Command WorkStation LE provide graphical means to monitor, preview, and manage jobs on one or more Fiery servers. You can hide or rearrange the components in the interface to create custom layouts that meet your job management needs.

The following illustrations show the components of Command WorkStation and Command WorkStation LE.

# 2

## 2-26 Introduction to Command WorkStation and Command WorkStation LE

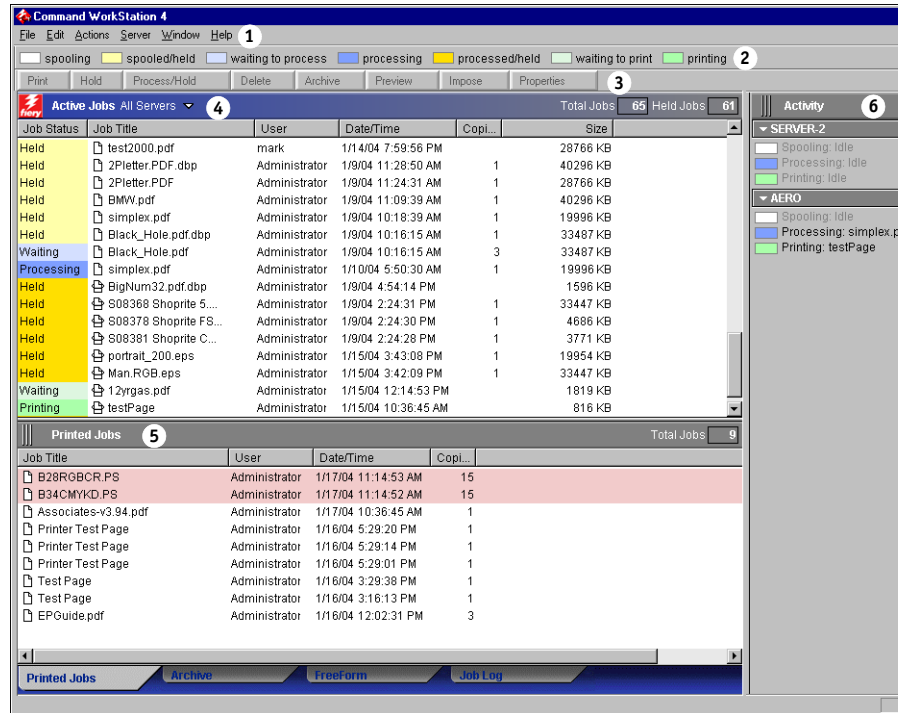

### Command

- 1 Menu bar (see page 2-42)
- 2 Job status indicators (see page 2-36)
- 3 Action buttons (see page 2-38)
- 4 Active Jobs window (see page 2-28)
- 5 Jobs window (see page 2-30)
- 6 Activity Monitor (see page 2-32)

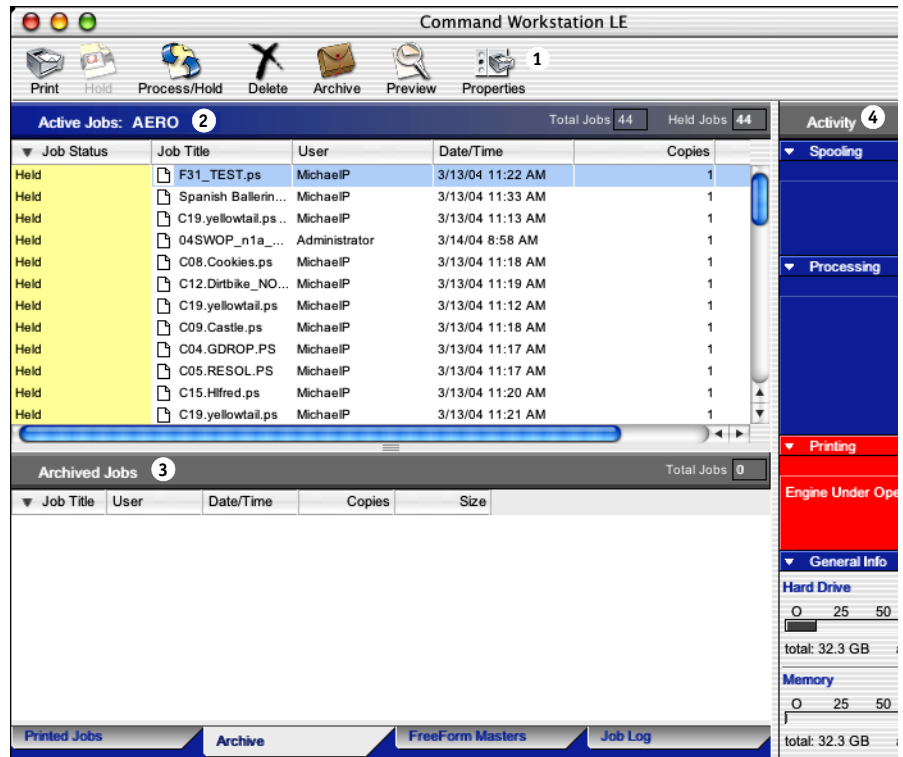

### Command

- 1 Action buttons (see [page 2-38](#))
- 2 Active Jobs window (see [page 2-28](#))
- 3 Jobs window (see [page 2-30](#))
- 4 Activity Monitor (see [page 2-32](#))

The following sections describe each component in Command WorkStation and Command WorkStation LE.

## Active Jobs window

The Active Jobs window dynamically displays the status and job ticket information of jobs that are currently being held, processed, or printed on the Fiery. The title bar displays the total number of jobs and the total number of held jobs currently being monitored.

The Active Jobs window is always displayed. You cannot hide or drag it to a different location. By issuing job management commands, you release held jobs in the window for processing and printing, cancel jobs currently processing or printing, and send jobs back to held status for future action. For more information on the status flags displayed in the Active Jobs window, see ["Job status indicators"](#) on page 2-36.

### Server selection menu

### Job ticket information

Job Status	Job Title	User	Date/Time	Copi...
Held	2Pletter.PDF.dbp	Administrator	1/9/04 11:28:50 AM	1
Held	2Pletter.PDF	Administrator	1/9/04 11:24:31 AM	1
Held	BMW.pdf	Administrator	1/9/04 11:09:39 AM	1
Held	simplex	Administrator	1/9/04 10:18:39 AM	1
Held	Black_Hole.pdf.dbp	Administrator	1/9/04 10:16:15 AM	1
Waiting	Black_Hole.pdf	Administrator	1/9/04 10:16:15 AM	3
Processing	simplex ver.1.2 011...	Administrator	1/10/04 5:50:30 AM	1
Held	BigNum32.pdf.dbp	Administrator	1/9/04 4:54:14 PM	1
Held	S08368 Shoprite 5...	Administrator	1/9/04 2:24:31 PM	1
Held	S08378 Shoprite FS...	Administrator	1/9/04 2:24:30 PM	1
Held	S08381 Shoprite C...	Administrator	1/9/04 2:24:28 PM	1

### Command WorkStation

# 2

## 2-29 The graphical interface

### Job ticket information

Job Status	Job Title	User	Date/Time	Copies
Held	F31_TEST.ps	MichaelIP	3/13/04 11:22 AM	1
Held	Spanish Ballerin...	MichaelIP	3/13/04 11:33 AM	1
Held	C19.yellowtail.ps	MichaelIP	3/13/04 11:13 AM	1
Held	04SWOP_n1a_...	Administrator	3/14/04 8:58 AM	1
Held	C08.Cookies.ps	MichaelIP	3/13/04 11:18 AM	1
Held	C12.Dirtbike_NO...	MichaelIP	3/13/04 11:19 AM	1
Held	C19.yellowtail.ps	MichaelIP	3/13/04 11:12 AM	1
Held	C09.Castle.ps	MichaelIP	3/13/04 11:18 AM	1
Held	C04.GDROP.PS	MichaelIP	3/13/04 11:17 AM	1
Held	C05.RESOL.PS	MichaelIP	3/13/04 11:17 AM	1
Held	C15.Hilfred.ps	MichaelIP	3/13/04 11:20 AM	1
Held	C19.yellowtail.ps	MichaelIP	3/13/04 11:21 AM	1

### Command WorkStation LE

In the Active Jobs window, you can:

- Monitor and manage jobs on the Fiery (see [page 3-71](#))
- Customize job ticket information (see [page 3-72](#))
- Monitor jobs on multiple Fiery servers\* (see [page 2-38](#))

## Jobs window

The Jobs window displays information about jobs that have printed successfully through a connected Fiery. The window is divided into four layered panels. Click the selection tabs at the bottom of the window to move between different panels.

The following illustration shows the Jobs window for Command WorkStation, which is nearly identical to the Jobs window for Command WorkStation LE.

Printed Jobs					Total Jobs
Job Title	User	Date/Time	Copi...	Size	42
25A3.PS	Administrator	1/10/04 11:26:55 AM	1	126931 KB	
Black_Hole.pdf	Administrator	1/10/04 11:26:50 AM	1	5108 KB	
Anglefish.pdf	Administrator	1/10/04 11:26:27 AM	1	439 KB	
EMV.pdf	Administrator	1/10/04 11:26:27 AM	1	52317 KB	
4pgLetterPM65.pdf	Administrator	1/10/04 11:24:21 AM	1	77 KB	
Black_Hole.ps	Administrator	1/10/04 11:24:21 AM	1	376383 KB	
J.Brahms.ps	Administrator	1/10/04 11:23:44 AM	1	151932 KB	
pm021tabslpdf.ps	Administrator	1/10/04 10:07:41 AM	1	935 KB	
pm021tabslpdf.pdf	Administrator	1/10/04 10:07:40 AM	1	522 KB	

Printed Jobs tab

In each panel, the title bar displays the name of the panel and the total number of jobs displayed.

All panels of the Jobs window allow you to customize the job ticket information (see [page 3-72](#)).

### Printed Jobs panel

The Printed Jobs panel lists all jobs that have been printed from the ES3640e MFP. Newly printed jobs are added to the top of the list. The Printed Jobs panel lists all printed jobs until the job limit (determined by the administrator in Fiery Setup) is reached. When the first job over the limit is printed, the oldest job is deleted from the Printed Jobs list.

**Note:** The Printed Jobs panel doesn't list the following types of jobs: jobs printed through the Direct queue and jobs printed with the Print Pages command.

### Archive panel

The Archive panel lists all files and jobs stored in the job archive.

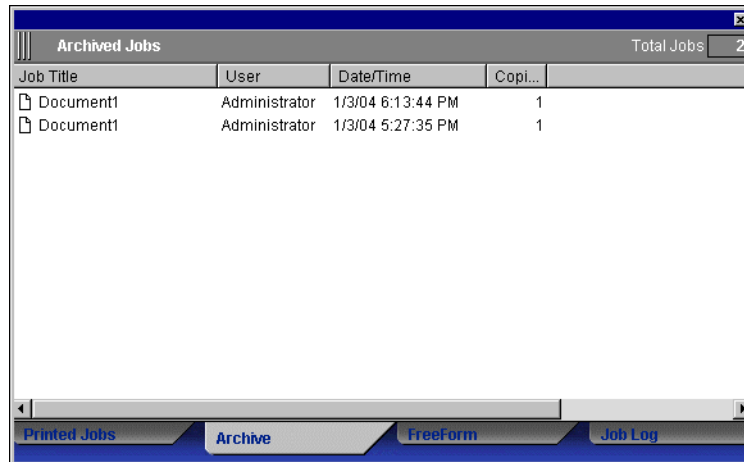

Job Title	User	Date/Time	Copi...
Document1	Administrator	1/3/04 6:13:44 PM	1
Document1	Administrator	1/3/04 5:27:35 PM	1

For information about using the Archive panel, see ["Archiving jobs"](#) on page 3-94.

### FreeForm panel

The FreeForm panel lists the names of all master files used for Fiery FreeForm variable data printing. Jobs listed in the FreeForm panel represent master files that have already been RIPPed and stored on the Fiery.

The screenshot shows the 'Freeform Masters' panel with a table of jobs. The table has columns for Job Title, User, Date/Time, and Copied. There are three rows of data. Below the table are buttons for 'Printed Jobs', 'Archive', 'FreeForm', and 'Job Log'.

Job Title	User	Date/Time	Copi...
S08368 Shoprite 5...	Administrator	1/9/04 2:24:30 PM	1
S08378 Shoprite FS...	Administrator	1/9/04 2:24:29 PM	1
S08381 Shoprite C...	Administrator	1/9/04 2:24:28 PM	1

The FreeForm panel is not available if you logged in as Guest. For information on working with FreeForm jobs and the FreeForm panel, see [page 3-89](#).

### Job Log panel

The Job Log panel lists all processed and printed jobs and includes the date and time the jobs were printed.

The screenshot shows the 'Job Log' panel with a table of jobs. The table has columns for Print Status, Job Title, User, Date/Time, and Size. There are ten rows of data. Below the table are buttons for 'Printed Jobs', 'Archive', 'FreeForm', and 'Job Log'.

Print Status	Job Title	User	Date/Time	Size
OK	http://www.roman...	Pat	1/12/04 5:18:20 PM	311 KB
OK	http://www.roman...	Pat	1/12/04 5:17:52 PM	256 KB
OK	http://www.roman...	Pat	1/12/04 5:17:21 PM	253 KB
OK	http://www.roman...	Pat	1/12/04 5:16:37 PM	343 KB
OK	DSfinaloutput2.pdf	Leslie	1/12/04 4:51:43 PM	4573 KB
OK	Start Page	Operator	1/12/04 4:43:11 PM	1201 KB
OK	Start Page	Operator	1/12/04 4:15:25 PM	1201 KB
OK	Online Membership...	sam	1/12/04 4:05:06 PM	46 KB
OK	Start Page	Operator	1/12/04 4:03:35 PM	1201 KB

The Job Log panel is not available if you logged in as Guest. For information on using the Job Log panel, see [page 3-96](#).

### Activity Monitor

The Activity Monitor displays a summary of the job activity on all Fiery servers or a selected Fiery. The activity shown can include



jobs released for spooling, processing (RIPping), or printing. Held jobs do not appear in the Activity Monitor.

Display the Activity Monitor by choosing Activity Monitor from the Windows menu. In Command WorkStation, you can use the server selection menu in the Active Jobs window to display job activity for an individual Fiery, or for all servers (see [page 2-38](#)).

### All Servers view\*

In Command WorkStation, the All Servers view of the Activity Monitor summarizes the activity on all connected Fiery servers.

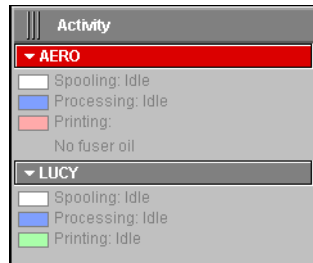

- **Server Name**—Each Fiery appears in a Server Name bar. Click the bar to expand or collapse activity information for a particular Fiery.
- **Spooling, processing, and printing jobs**—When you expand the Server Name bar for a Fiery, any current job activity on that Fiery appears next to a corresponding status box (spooling, processing, or printing). When no activity occurs on the Fiery, the status boxes read Idle.
- **Error conditions**—When an error occurs, the Server Name bar for the affected Fiery appears highlighted in red. Details of the error appear under the expanded bar.

### Selected Server view

When you select an individual Fiery in Command WorkStation, the Activity Monitor provides a more detailed summary of the current activity on that Fiery. In Command WorkStation LE, the Activity Monitor always displays the current activity on the connected Fiery. Animated images provide visual indications of the job activity.

Jobs being held, waiting to process, or waiting to print are not displayed.

# 2

## 2-35 The graphical interface

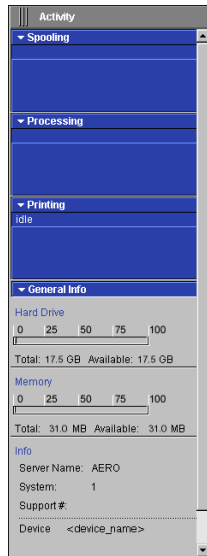

**Command WorkStation**



**Command WorkStation LE**

Four sections appear for a selected server. Click the title bar for each section to expand or collapse the display of each section.

**Spooling**—Displays the file name of the job spooling to the Fiery hard disk.

**Processing**—Displays the file name of the job currently being processed (RIPped), along with an animated preview of the page currently being processed.

**Printing**—Displays the file name of the job currently being printed, and the page number currently printing. With multiple copies, the copy number is also displayed.

**General Info**—Displays the total and available hard disk drive space, and the total and available memory of the Fiery. This section also provides the Fiery name, system software version, technical support number, and printer name.

## Job status indicators

Job status indicators define the color in the Active Jobs window and Activity Monitor to indicate the current status of jobs. For information on how each indicator relates to job flow on the Fiery, see ["Understanding job flow"](#) on page 1-17.

In Command WorkStation, a key for the job status indicators is displayed below the menu bar:

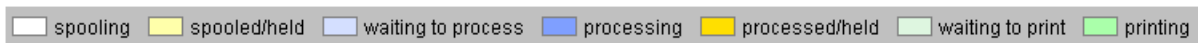

The color-coded job status indicators identify:

**spooling (white)**—The job file is being copied to the Fiery hard disk drive.

**spooled/held (light yellow)**—The job has been downloaded to the Fiery hard disk drive and requires job management instructions from the operator.

**waiting to process (light blue)**—The job is queued to be processed (RIPped).

**processing (medium blue)**—The job is currently being processed (RIPped).

**processed/held (dark yellow)**—The job has been processed (RIPped) and requires job management instructions from the operator.

**waiting to print (light green)**—The job is queued to be printed.

# 2

## 2-37 | The graphical interface

**printing (bright green)**—The job has been received by the Fiery.

## Action buttons

Action buttons provide convenient access to frequently used job management commands. You can also issue these commands by choosing them from the menu bar or the context-sensitive menus. For a detailed description of each Action button command, see the table on [page 2-42](#).



**Command WorkStation**



**Command WorkStation LE**

---

## To issue an Action button command

1. **Select a job in the Active Jobs window or the Jobs window.**
2. **Click the desired Action button.**

When a command is unavailable in the current context, its Action button appears dimmed.

## Preview windows

The Preview windows allow you to view thumbnail previews of selected jobs. You can also use the Preview windows to reorder and delete pages of a job, and to merge pages from several jobs into a single, merged job.

## Monitoring single or multiple Fiery servers\*

In Command WorkStation, you can set the Active Jobs window, Jobs window, and Activity Monitor to display job information for a single Fiery or all connected Fiery servers.

---

### To specify the Fiery being monitored

1. **Click the arrow in the server selection menu of the Active Jobs window, Jobs window, or Activity Monitor.**

A menu appears, listing the names of all connected Fiery servers.

2. **To display jobs for an individual Fiery, choose the Fiery from the list. To monitor jobs for all connected Fiery servers, choose All Servers.**

Print jobs on the specified Fiery servers are displayed.

## Customizing the graphical interface

Command WorkStation and Command WorkStation LE offer you the flexibility of showing, hiding, rearranging, and docking user interface components to fit your workflow needs. For example, you may only need a few components, or you may prefer to arrange components side by side for ease of use. In Command WorkStation, you can also choose one of three preset layouts.

You can also customize the appearance of job ticket information in the Active Jobs and Jobs windows. For more information, see [page 3-72](#).

### Using layout styles\*

Command WorkStation provides three preset and three customizable layout styles. When you choose the command corresponding to a layout style, the display updates to show a specific arrangement of components.

---

### To select a layout style

- **Choose Layouts from the Window menu, and then choose a layout style from the submenu that appears.**

You can choose one of three preset layouts (Default, Style 1, or Style 2) and three custom layouts. For a description of the components included with each of the preset layouts, see [page 2-49](#).

You can define and change the configurations associated with the three custom layout styles. For details, see the following section.

### **Showing, hiding, and arranging components**

Use Window menu commands to show or hide window components. You can also drag components to different locations in the window, and dock components side by side.

**Note:** You cannot hide or drag the menu bar or Active Jobs window to different locations. These components always appear in the Command WorkStation or Command WorkStation LE window.

---

#### **To show or hide a component**

- **Choose the command associated with the component from the Window menu.**

When a component is displayed, a check mark appears next to it in the Window menu.

---

#### **To move a component to another location**

- **Click the window grip (three vertical lines) on the left side of the component's title bar (Command WorkStation) or click the component's title bar (Command WorkStation LE), and drag the window to the desired location.**

Undocked components float in front of other components and appear with standard window frames. Drag the blank title bar of the window to move the component, or drag the edges of the window to resize the component. You can also click the window Close box to hide the component.

**Note:** When the Jobs window is docked, you can resize it vertically by clicking and dragging its top edge.



---

**to dock or undock a component**

- **Double-click the window grip in the component's title bar.**

---

**To save the current display configuration as a layout style in Command WorkStation\***

- 1. Choose Save Layout from the Window menu.**
- 2. In the dialog box that appears, choose the style you want to update, and, if desired, rename the style.**
- 3. Click OK to save the new layout style.**

## Using commands

You can perform a wide variety of functions using Command WorkStation and Command WorkStation LE commands, which you access from menus in the menu bar at the top of the Command WorkStation or Command WorkStation LE window. When one or more jobs are selected, you can choose job management commands from context-sensitive menus. In addition, you can issue some job management commands by clicking their Action buttons (see [page 2-38](#)).

### Menu bar

The menu bar contains commands for Command WorkStation or Command WorkStation LE. When a command is unavailable in the current context, it appears dimmed in the menu. When a command appears with a check mark, choosing it again toggles the command, turning it off.

The menu bar always appears in the Command WorkStation window, and cannot be dragged to a different location.

**Note:** In the following table, an asterisk (\*) indicates that the command or menu is available for Command WorkStation only. A dagger (†) indicates that the command or menu is available for Command WorkStation LE only.

# 2

<b>Menu</b>	<b>Command</b>	<b>Submenu command</b>	<b>Description</b>
CWS LE†	About LE†		Displays information about the current version of Command WorkStation LE
	Preferences†		Allows you to change the Command WorkStation LE preference settings.
	Services†		The commands under this submenu are disabled for Command WorkStation LE.
	Hide CWS LE†		Minimizes and hides the Command WorkStation LE application window. The application continues to run in the background.
	Hide Others†		Minimizes and hides all currently running applications other than Command WorkStation LE. The hidden applications continue to run in the background.
	Show All†		Maximizes and brings to the foreground all applications that are currently running on the computer.
	Quit CWS LE†		Exits the Command WorkStation LE application.

<b>Menu</b>	<b>Command</b>	<b>Submenu command</b>	<b>Description</b>
File	Import	Job	Imports a job file into the Direct, Hold, or Print queue of the Fiery.
		Archived Job	Imports an archived job file into the Hold queue of the Fiery.
	Export	Active Window*	Exports the contents of the Active Jobs window to a tab-delimited text file.
		[current panel of Jobs Window]*	Exports the contents of the current panel of the Jobs window to a tab-delimited text file.
		Job List†	Exports the contents of the Active Jobs window to a tab-delimited text file.
		Job Log†	Exports the contents of the Job Log panel to a tab-delimited text file.
	Print*	Job Log*	Prints the current Job Log on a local printer.
		Active Window*	Prints the contents of the current window on a local printer.
	Exit*		Closes the Command WorkStation application window.
	Close†		Closes the Command WorkStation LE application window.
Edit	Find		Allows you to search selected Fiery servers for jobs that match certain search criteria.
	Preferences*		Allows you to change the Command WorkStation preference settings.
	Undo, Cut, Copy, Paste†		Applies the specified action on the selection. For more information, see Mac OS Help.

<b>Menu</b>	<b>Command</b>	<b>Submenu command</b>	<b>Description</b>
Actions	Print		Prints the selected job in the Active Jobs window, Printed Jobs panel or Archive panel.
	Delete		Deletes the selected job in the Active Jobs window, Printed Jobs panel, FreeForm panel, or Archive panel. You cannot delete jobs currently spooling, processing, or waiting to print.
	Duplicate		Duplicates the selected held job in the Active Jobs window.
	Rename		Allows you to rename the selected held job in the Active Jobs window, or the Printed Jobs panel or Archive panel.
	Hold		Holds the selected job waiting to process in the Active Jobs window, or the Printed Jobs or Archive panel, and marks the job with the spooled/hold flag or the processed/hold flag.
	Process and Hold		Processes the selected job in the Active Jobs window, Printed Jobs panel, or Archive panel, and holds a copy of the job. The copied job is marked with the processed/hold flag.
	Print and Hold		Prints the selected job in the Active Jobs window, Printed Jobs panel, or Archive panel, and holds a copy of the job. The copied job is marked with the processed/hold flag.
	Remove Raster Data		Removes the raster data associated with the selected processed/hold job in the Active Jobs window, or the selected raster job in the Printed Jobs or Archive panel; leaves the original PostScript job in place.
	Properties		Allows you to view and override print settings for the selected job in the Active Jobs window or Printed Jobs panel, or view print settings for the selected job in the FreeForm panel or Archive panel.
	Separation List		If the Print Server supports this option, allows you to override screen angles or reduce the number of colors used in your job. For more information, see the documentation that came with the Print Server. Is this appropriate?

# 2

<b>Menu</b>	<b>Command</b>	<b>Submenu command</b>	<b>Description</b>
Actions (cont.)	Preview		Opens the selected job in a Preview window. You can preview held jobs that reside in the Active Jobs window, as well as jobs that reside in the Printed Jobs panel, FreeForm panel, or Archive panel.
	Archive		Archives the selected held job in the Active Jobs window, moving it to the Archive panel.
	Send To*		Sends the selected held job in the Active Jobs window to another Fiery.
	Cancel Processing		Cancels processing of the selected job in the Active Jobs window. This command is available only for jobs displaying the processing status flag.
	Cancel Printing		Cancels printing of the selected job in the Active Jobs window. This command is available only for jobs displaying the printing status flag.
	Impose*		Allows you to apply imposition settings to the selected held job in the Active Jobs window.
	Mixed Media Setup*		Allows you to specify different media types for different page ranges in the selected spooled/held job.

Menu	Command	Submenu command	Description
Server	Log In/Log Out		Allows you to log in or log out of the Fiery and add or remove Fiery servers from the list.
	Setup*		Opens the Setup options for the Fiery.
	Manage Color*		Opens ColorWise Pro Tools. For more information, see the <i>Color Guide</i> .
	Manage Fonts		Allows you to view and print a list of fonts on the Fiery. In Command WorkStation, it also allows you to download fonts to the Fiery, as well as delete fonts that you have downloaded.
	Align Trays*		Allows you to adjust placement of the printed image on the page to correct for misalignments of the paper tray.
	Printing Groups*		Allows the Fiery Administrator to set up printing groups and passwords. For more information about Printing Groups and Secured Print (Member Printing), see the <i>Configuration Guide Chapter 5</i> .
	Reorder Jobs*		Allows you to reorder the priority of jobs that are waiting to process or print.
Server (cont.)	Restart Server		Allows you to restart the Fiery without shutting down the Fiery hard disk drive. This command is available only if you are logged in as Administrator. After you restart the Fiery, you may need to log in to the Fiery again to reestablish the connection.
	Reboot Server		Allows you to restart the Fiery, after shutting down the Fiery hard disk drive. This command is available only if you are logged in as Administrator. After you restart the Fiery, you may need to log in to the Fiery again to reestablish the connection.

# 2

Menu	Command	Submenu command	Description
	Job Log*	Export*	Exports the contents of the Job Log panel to a tab-delimited text file.
		Export and Clear*	Exports the contents of the Job Log panel to a tab-delimited text file, and clears the contents of the job log for the Fiery.
	Clear Job Log†		Clears the contents of the job log for the Fiery.
	Clear Server		Allows the administrator to clear or delete the following file types from the currently selected server: Held Jobs, Active Jobs, Printed Jobs, Archived Jobs - Server Internal, Archived Jobs - Network Links, FreeForm Masters, Job Log, and Scan Jobs.
	Print Pages		<p>Allows you to print the following information pages:</p> <ul style="list-style-type: none"> <li>PS Test Page</li> <li>PCL Test Page</li> <li>Configuration page</li> <li>Job Log</li> <li>Color Charts</li> <li>PS Font List</li> <li>PCL Font List</li> </ul> <p>Command WorkStation also allows you to print the following information pages about the Fiery to the local printer:</p> <ul style="list-style-type: none"> <li>Archive Log</li> <li>Queues</li> </ul>
	Suspend Printing		Suspends or pauses printing on the Fiery.
	Resume Printing		Resumes printing on the Fiery.



Menu	Command	Submenu command	Description
Window	Layouts*	Default*	Displays the following Command WorkStation components: Menu bar Job Status Helper Action buttons Active Jobs window Jobs window Activity Monitor (selected server view)
		Style 1*	Displays the following Command WorkStation components: Menu bar Job status indicators Action buttons Active Jobs window
		Style 2*	Displays the following Command WorkStation components: Menu bar Job status indicators Action buttons Active Jobs window Activity Monitor (all servers view)
		<i>Custom 1, Custom 2, or Custom 3*</i>	Sets the Command WorkStation window to a custom layout previously defined and named using the Save Layout command.
	Save Layout*		Allows you to save and name the current Command WorkStation display as a custom layout. Saved layouts appear as commands in the Window > Layouts submenu. You can save up to three custom layouts.
	Jobs Window		Switches the Jobs window on or off. A check mark next to the command indicates that the Jobs window is displayed.
	Activity Monitor		Switches the Activity Monitor on or off. A check mark next to the command indicates the Activity Monitor is displayed.
	Action Buttons*		Switches the Action buttons on or off. A check mark next to the command indicates the buttons are displayed.

Menu	Command	Submenu command	Description
Window (cont.)	Job Status Helper*		Switches the Job Status Helper on or off. A check mark next to the command indicates the helper is displayed.
	Tile Preview Windows†		Displays active Preview windows in tiled formation so that the windows are simultaneously visible.
	Cascade Preview Windows†		Displays active Preview windows in cascading formation so that the windows are stacked with their title bars visible.
	Preview- <Job Name>		Activates the open Preview window of the named job. This menu option appears for each open Preview window.
	More Previews*		Opens a Previews window, where you can activate, close, cascade, and minimize the open Preview windows.
Help*	About Command WorkStation*		Displays information about the current version of Command WorkStation.

## Context-sensitive menus

When you select one or more jobs in the Active Jobs or Jobs window, you can display context-sensitive menus containing job management commands for selected jobs.

---

### To display a context-sensitive menu

- 1. Select one or more jobs in the Active Jobs or Jobs window.**

For details on how to select jobs, see [page 3-71](#).

- 2. Right-click the selected job (Command WorkStation) or Control-click the selected job (Command WorkStation LE).**

When multiple jobs are selected, you can right-click or Control-click any of the selected jobs.

- 3. Choose the desired command from the context-sensitive menu.**

## Preparing to work with Command WorkStation or Command WorkStation LE

This section describes the setup and administrative tasks required to begin working with Command WorkStation or Command WorkStation LE.

### **Connecting to the Fiery**

In Command WorkStation, you can maintain connections to multiple Fiery servers simultaneously. In Command WorkStation LE, you can maintain a connection to one Fiery server at a time.

---

#### **To connect to the Fiery**

- 1. Choose Log in/Log out from the Server menu.**  
The server list is displayed.
- 2. Select the Fiery from the list of Fiery servers you have connected to before.**

The server list displays the Fiery servers you can monitor and manage from Command WorkStation or Command WorkStation LE. You can add and remove Fiery servers from the list of Fiery servers you frequently monitor.

# 2

## 2-52 Introduction to Command WorkStation and Command WorkStation LE

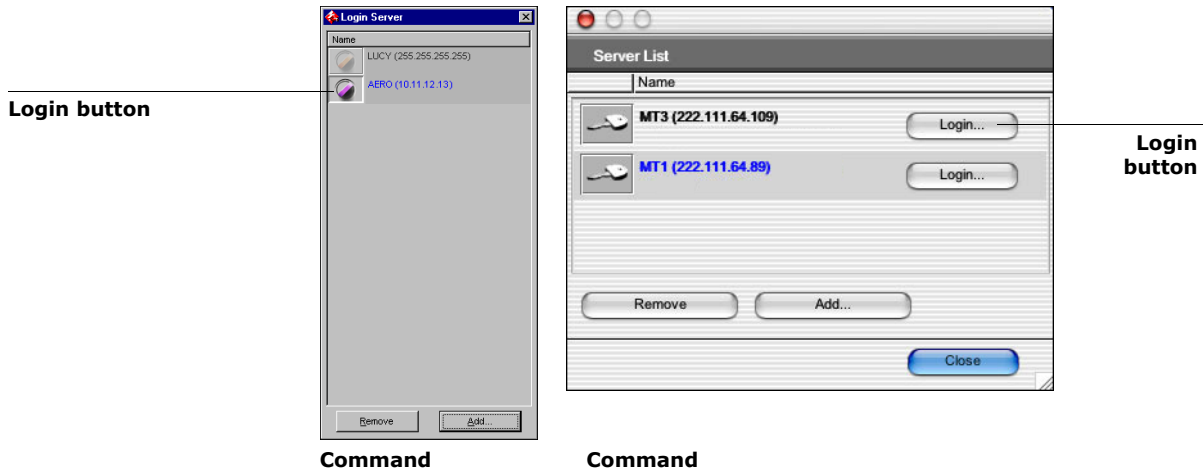

Command

Command

Each row in the server list displays the name of a Fiery, the name of the printer associated with that Fiery, and a Login button.

3. Click the **Login button** next to the **Fiery** name to establish the connection.
4. Select the **Administrator, Operator, or Guest** option, enter your password, and then click **Log In (Command WorkStation)** or **Login (Command WorkStation LE)**.



Command WorkStation



Command WorkStation LE

## Printing Fiery information pages

Use the Print Pages command to print information about the Fiery. The pages provide useful reference information for setting up or troubleshooting the Fiery.

---

### To print Fiery information pages

1. **In the Active Jobs window, select the Fiery for which you want to print information pages.**

**Note:** To print information pages, you must be logged in to the Fiery as Administrator.

2. **Choose Print Pages from the Server menu.**

A dialog box containing the information page options appears.

**Note:** Local Printer options are available in Command WorkStation only.

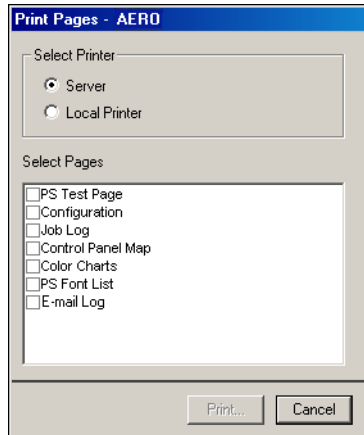
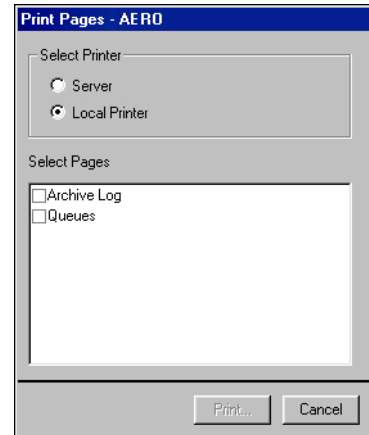
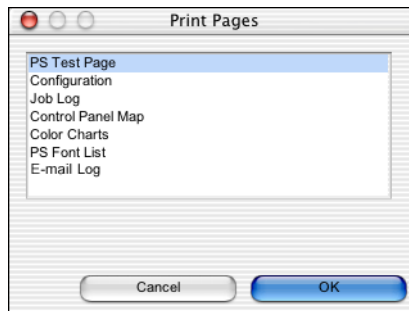
**Command WorkStation****Server options****Local Printer options****Command WorkStation LE**

- 3. For Command WorkStation, in the Select Printer area, specify where you want to print the pages.**

**Server**—The pages you specify are printed to the Fiery.

**Local Printer**—Allows you to print the Archive Log and Queues to any printer installed on your Windows computer.

- 4. In the Select Pages area (Command WorkStation) or in the Print Pages dialog box (Command WorkStation LE), specify the pages you want to print.**

Each set of pages contains specific information about the Fiery. You can print the following pages from the Fiery:

**PS Test Page/PCL Test Page**—Provides color and grayscale samples to troubleshoot problems with the Fiery. The following settings are among those listed on the Test Page: Server Name, color settings, calibration information, and date and time the Test Page was printed.

**Configuration**—Provides the current Fiery and printer configuration. This page lists general information about the hardware and software configuration of the Fiery, current settings for all Setup options, information about the current calibration, and the network addresses of the Fiery.

**Job Log**—Lists a log of the last 55 jobs processed or printed. For information on the fields in the Job Log and printing it in other forms, see ["Using the Job Log"](#) on page 3-96.

**Color Charts**—Provides samples of the RGB, CMY, and PANTONE colors available from the Fiery.

**PS Font List**—Lists all PostScript fonts currently resident on the Fiery hard disk drive.

**PCL Font List**—Lists all PCL fonts currently resident on the Fiery hard disk.

When you select the Local Printer option in Command WorkStation, you can print the following pages:

**Archive Log**—Lists all jobs displayed in the Archive panel.

**Queues**—Lists all jobs displayed in the Active Jobs window.

**5. Click Print (Command WorkStation) or OK (Command WorkStation LE).**

Fiery information pages printed with the Print Pages command appear in the Fiery Job Log with the user name Operator, even if you logged in as Administrator.

## Setting preferences

The Preferences dialog box enables you to control application settings.

---

### To set preferences for Command WorkStation\*

#### 1. Choose Preferences from the Edit menu.

The Preferences dialog box appears.

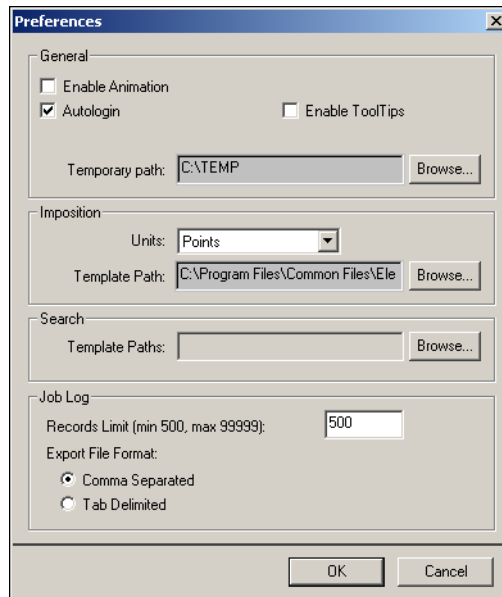

#### 2. Specify the desired preference settings, and click OK to save your settings.

The following preferences can be specified:

**Enable Animation**—Enables the display of animated graphics in the Selected Server view of the Activity Monitor (see [page 2-34](#)).

**Autologin**—Instructs Command WorkStation to remember the last access level and password used to log in to each Fiery. When you log in to the Fiery again, Command WorkStation automatically populates the Login dialog box with the previous access level and password.



**Enable ToolTips**—Enables the display of ToolTips, or context-sensitive text which appears when you move the mouse pointer over particular buttons and options in Command WorkStation.

**Temporary path**—Specifies the folder where Command WorkStation temporarily stores copies of the jobs you edit or change. Change the temporary path by clicking Browse and specifying a folder.

**Imposition: Units**—Specifies the units of measurement used to display attributes, such as page sizes and custom sizes, in the Job Properties dialog box and Imposition window.

**Imposition: Template Path**—Specifies the folder where template files for imposition are stored for later use. To change the template path, click Browse and specify a folder.

**Search: Template Paths**—Specifies the folder where Find/Search templates are stored for later use. To change the template path, click Browse and specify a folder.

---

### To set preferences for Command WorkStation LE†

#### 1. Choose Preferences from the CWS LE menu.

The Preferences dialog box appears.

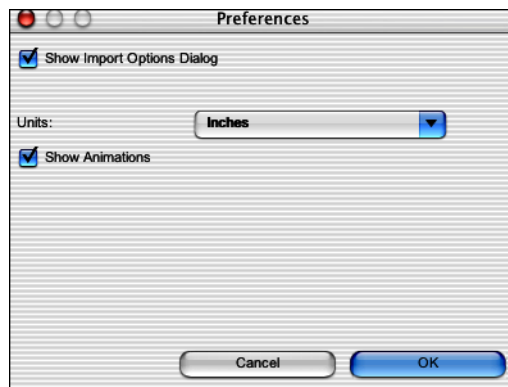

#### 2. Specify the desired preference settings and click OK to save your settings.

The following preferences can be specified:

**Show Import Options Dialog**—When enabled, this preference setting displays a dialog box that allows you to specify the destination queue (Hold or Print) for each job imported into Command WorkStation LE.

**Units**—Specifies the units of measurement used by Command WorkStation LE to display values that you enter manually in the Job Properties dialog box.

**Show Animations**—Enables the display of animated graphics in the Activity Monitor (see [page 2-32](#)).

### **Correcting tray alignment\***

The Tray Alignment feature in Command WorkStation allows you to adjust the placement of text and images on the page so they are correctly aligned on the sheet of paper, or both sides of a duplex sheet have exactly the same alignment.

**Note:** To perform tray alignment, you must be logged in to the Fiery with Administrator privileges.

---

#### **To align text and images for printing\***

- 1. In the Active Jobs window of Command WorkStation, select the connected Fiery for which you want to perform Tray alignment.**

If the Active Jobs window is hidden, choose Active Jobs from the Window menu to display it.

- 2. Choose Align Trays from the Server menu.**

A dialog box containing the Tray Alignment options appears.

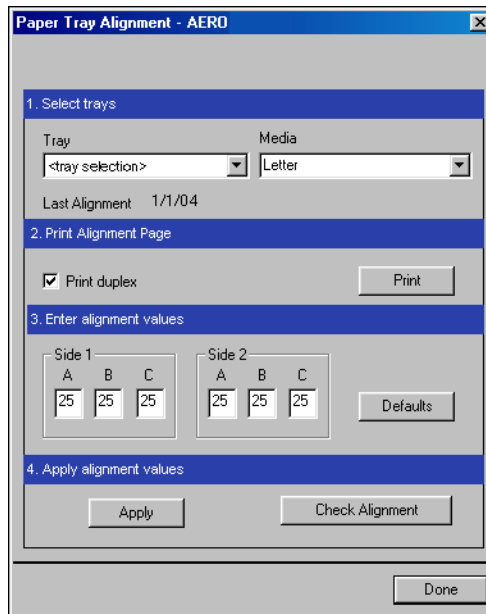

3. Choose the tray you want to align from the Tray menu.
4. Choose the paper size loaded in the tray from the Media menu.  
**Note:** The Tray Alignment is specific to the combination of tray and paper size specified. If you align a given tray with Letter paper, and load Legal paper in that tray, the alignment will be invalid. You must perform a new Paper Tray Alignment for each combination of tray and paper size.
5. In the Print Alignment Page section, select the Print Duplex option to print a duplex page, or clear the option to print a simplex page.
6. Click Print to print the alignment page.
7. Once the page has printed, follow the directions on the alignment page.

Fold the page exactly in half horizontally, unfold it, and then fold it in half vertically. When you unfold the sheet again, you will see that the fold lines cross three scales on three sides of the page. Determine which number on the scale each fold line crosses.

- 8. In the Enter alignment values section, enter the value where the fold crosses each of the three scales, marked A, B, and C, for Side 1. If you choose to align for duplex printing, enter the values for the three scales on Side 2 of the page, as well.**

**Note:** If you enter different values in A and C, the image will rotate, leading to uneven areas on printed output. If this occurs, enter the same value in A and C.

- 9. When you have entered all of the alignment values, click Apply, and then click Check Alignment to print the new alignment page.**
- 10. To remove the alignments, select a tray and click Defaults in the Enter alignment values section.**
- 11. Click Done.**

## Managing Fiery fonts

The Fiery includes a number of built-in printer fonts. You can download additional fonts to the Fiery using the Manage Fonts command in Command WorkStation. Users on the network can also download fonts to the Fiery using Fiery Downloader™ (see the [Printing Guide Chapter 4](#)).

**Note:** To manage fonts, you must be logged in to the Fiery with Administrator privileges.

Downloading fonts, either from Command WorkStation or with Fiery Downloader, requires that the Direct connection be published in Setup (see the [Configuration Guide](#)).

**Note:** You cannot download TrueType fonts. If you use TrueType fonts in Windows, you can print them by converting them to Adobe Type 1 fonts. To convert TrueType fonts with the Adobe PS printer driver, click the Fonts tab and set up the Font Substitution Table, as necessary.

To print a list of fonts currently resident on the Fiery, use the Print Pages command (see [page 2-53](#)).

---

### To manage fonts

- 1. In the Active Jobs window, select the connected Fiery for which you want to manage fonts.**

If the Active Jobs window is hidden, choose Active Jobs from the Window menu to display it.

**Note:** To manage fonts, you must be logged into the Fiery with Administrator privileges.

### 2. Choose Manage Fonts from the Server menu.

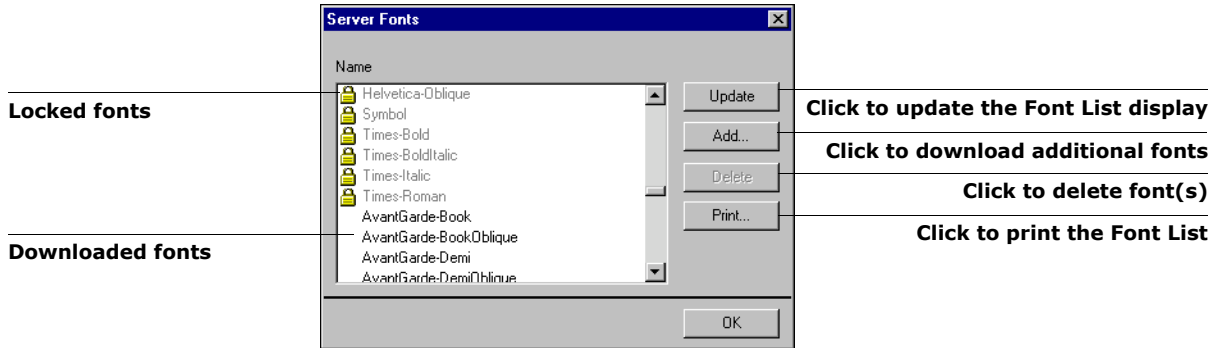

Command WorkStation

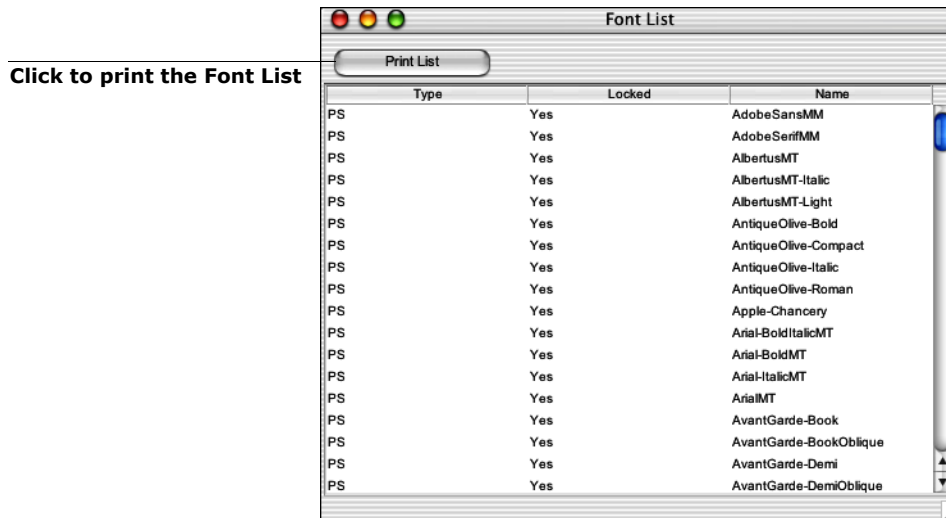

Command WorkStation LE

3. Select the PostScript or PCL option to specify the type of fonts displayed.
4. In Command WorkStation, click Add to download additional fonts to the Fiery. For additional steps, refer to the procedure on [page 2-63](#).

5. To delete a font in Command WorkStation, select the font you want to delete in the Font List, and click Delete.

To select multiple sequential fonts in Command WorkStation, select the first font and Shift-click the last font; Ctrl-click to select multiple non-sequential fonts.

**Note:** The printer fonts included with the Fiery (built-in fonts) are locked. These fonts appear with a lock icon next to the name (Command WorkStation) or with "Yes" in the Locked column (Command WorkStation LE) and cannot be deleted.

6. To refresh the Font List in Command WorkStation, click Update.
7. To print the Font List, click Print (Command WorkStation) or Print List (Command WorkStation LE).

---

### To add fonts in Command WorkStation\*

1. In the Select Files to Import dialog box, choose the file types to display from the File of type menu.

All Known Formats lists all files in supported formats; All Files lists all files.

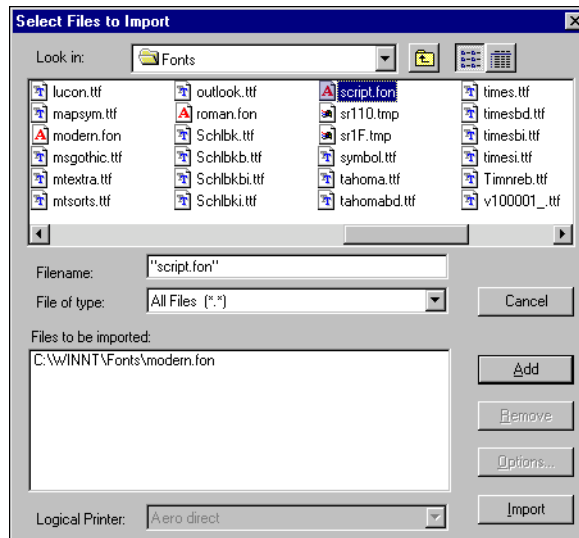

- 2. In the Look in menu, browse to the folder containing the font(s) you want to download.**

The Filename field displays the name of the selected file.

- 3. Select the font name and click Add.**

You can navigate to different drives and folders to select fonts to download.

To select multiple sequential fonts, select the first font and Shift-click the last font. Ctrl-click to select multiple non-sequential fonts.

To remove a font from the Files to be imported list, select the font name and click Remove.

- 4. When all the desired fonts appear in the Files to be imported list, click Import.**



## Chapter 3: Using Command WorkStation or Command WorkStation

This chapter describes how to use Command WorkStation and Command WorkStation LE to monitor and manage job flow on the Fiery. Once you log in to the Fiery with Operator privileges, you can view jobs held on the Fiery and issue commands to release the jobs for processing or printing. You can also modify job properties, such as FreeForm variable data printing requirements, paper settings, finishing options, and other print option settings. After a job has printed successfully, you can store it in the job archive, and view a record of its activity in the Job Log.

For background information on job flow and job management, see [Chapter 1](#). For an introduction to the Command WorkStation and Command WorkStation LE user interfaces, see [Chapter 2](#).

**Note:** Unless otherwise specified, information in this chapter applies to both Command WorkStation and Command WorkStation LE. Sections that apply exclusively to Command WorkStation are denoted by an asterisk (\*). Sections that apply exclusively to Command WorkStation LE are denoted by a dagger (†). In cases where the two applications are nearly identical, only Command WorkStation illustrations are shown.

### Starting up and logging in

To begin working with Command WorkStation or Command WorkStation LE, start the application and log in to the Fiery.

---

#### To start Command WorkStation\*

- **Click Start on the Windows taskbar, choose Programs > Fiery or All Programs > Fiery (Windows XP/Server 2003 only), and then choose Command WorkStation 4.**

When you start Command WorkStation for the first time, the Login Server list does not display any Fiery servers. For instructions on configuring and adding Fiery servers to the Login Server list, see the [User Software Installation Guide Chapter 1](#).

---

### To start Command WorkStation LE†

1. **In System Preferences/Network/Proxies, ensure that “SOCKS Proxy” is not checked.**
2. **Open the Command WorkStation LE folder, located inside the Applications folder on the Mac OS X hard disk.**
3. **Double-click the CWS LE file to start the application.**

When you start Command WorkStation LE for the first time, the server list does not display any Fiery servers. For instructions on configuring and adding Fiery servers to the server list, see the [User Software Installation Guide Chapter 2](#).

### Logging in to the Fiery

To establish a connection to the Fiery listed in the server list, log in to the Fiery.

In Command WorkStation, you can maintain connections to more than one Fiery at a time. Each Fiery connection requires an average of 4MB of RAM. The maximum number of simultaneous Fiery connections is limited only by the amount of RAM available on the system running Command WorkStation. For example, if your system has 128MB of RAM and is running Command WorkStation exclusively, you can log in to approximately 25 Fiery servers at one time.

---

### To log in to the Fiery

1. **From the Server menu, choose Log in/Log out (Command WorkStation) or Login/Logout (Command WorkStation LE).**

# 3

## 3-67 Starting up and logging in

The server list appears. The Fiery must appear in the list before you can log in to it.

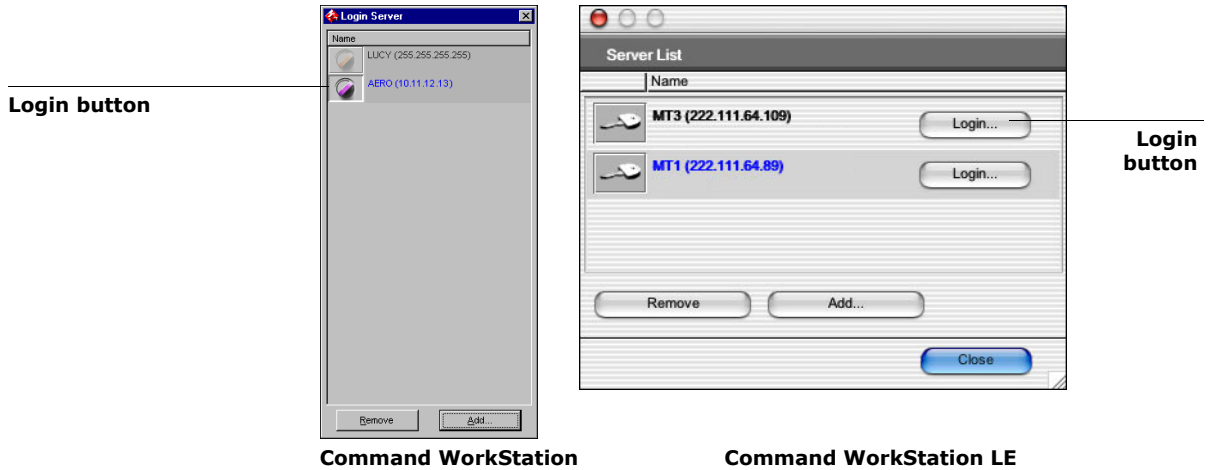

### 2. Click the Login button for the desired Fiery.

The Login dialog box appears.

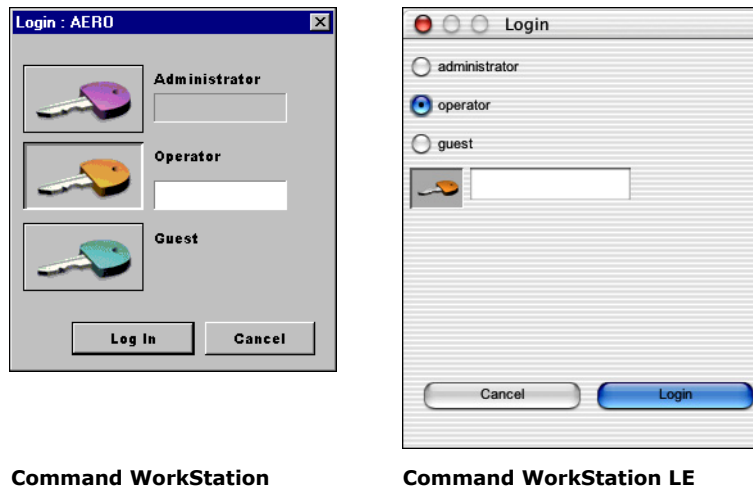

A white key icon indicates the Fiery has never been connected to Command WorkStation or Command WorkStation LE.

If the Fiery is already connected, the color of the key icon indicates the level of access granted:

- Purple indicates Administrator access.
- Orange indicates Operator access.
- Cyan indicates Guest access.

**3. Select the Administrator, Operator, or Guest option, enter your password, and then click Log In (Command WorkStation) or Login (Command WorkStation LE).**

This manual assumes you are logged into the Fiery as Operator. The following section discusses the three different access levels in greater detail.

### Access levels

The three possible levels of access to Command WorkStation or Command WorkStation LE are Administrator, Operator, and Guest. To enable maximum password protection, Administrator and Operator passwords must be specified in Setup (see the [Configuration Guide Chapter 7](#)).

When both Administrator and Operator passwords have been specified, the access levels are as follows:

Access level	Privileges and password requirements
Administrator	Has full access to all Command WorkStation and Command WorkStation LE functions; Administrator password required. For a description of the full range of tasks an administrator can implement, see the <a href="#">Configuration Guide Chapter 3</a> .
Operator	Has access to all Command WorkStation functions, <i>except</i> Setup, font management, reordering job priority, restarting the Fiery, clearing the Fiery hard disk drive, and clearing the Job Log. Operator password required.

Access level	Privileges and password requirements
Guest	Can view job status, but cannot make changes to jobs or Setup, and cannot access the Job Log; no password required.

**Note:** In Command WorkStation, a user may be logged in as Administrator on one Fiery, as Operator on a second Fiery, and as Guest on a third Fiery. In these instances, the levels of access are dependent either on the Fiery currently selected in the Active Jobs window or on the Fiery that holds the currently selected job.

By default, no passwords are set on the Fiery—in this default state, anyone can perform Setup and use all Command WorkStation and Command WorkStation LE functions. Until an Administrator password is defined in Fiery Setup, you can log in to the Fiery as an Administrator without entering a password and are given full privileges.

After the administrator has performed Setup and specified passwords, Command WorkStation and Command WorkStation LE user options depend on your login level. This manual assumes that you are logged in to the Fiery as Operator.

## Logging out

Logging out from the Fiery terminates the connection between the Fiery and Command WorkStation or Command WorkStation LE.

---

### To log out from a connected Fiery in Command WorkStation\*

1. From the Server menu, choose Log in/Log out.
2. Click the Login button for the connected Fiery in the server list.
3. Click Yes to log out from and disconnect the Fiery.

---

### To log out from a connected Fiery in Command WorkStation LE†

1. From the Server menu, choose Login/Logout.
2. Click the Logout button or key icon for the connected Fiery in the server list.

Command WorkStation LE disconnects from the Fiery.

3. Click Close to close the server list.

## Removing the Fiery from the server list

You can clear unused Fiery servers from the server list.

---

### To remove the Fiery from the server list

1. From the Server menu, select Log in/Log out.
2. Select the Fiery in the server list.
3. Click the Remove button to remove the Fiery from the list.  
The Remove button is available only for disconnected Fiery servers.

## Monitoring jobs

The Active Jobs window and the Printed Jobs panel of the Jobs window provide a visual means of monitoring the flow of print jobs through connected servers. In Command WorkStation, you can use the server selection menu in the title bar of each window to monitor a single Fiery or multiple Fiery servers (see [page 2-38](#)). You can also sort job lists and customize the job ticket information that is displayed.

The Active Jobs window displays jobs as they pass through the various stages of spooling, holding, processing, and printing. Flag colors indicate the status of each job, and job ticket columns provide additional job information. Jobs that contain raster data as a result of processing are marked with a halo around their file icons.

**Note:** When you pause a job during printing (by issuing the Suspend Printing command), the job continues to be marked with a dark green status flag in the Active Jobs window. However, the job is displayed as “Paused.”

When a job has completed printing (or has failed to print), it drops from the Active Jobs window and is added to the Printed Jobs panel. The Printed Jobs panel displays jobs that have printed successfully, along with failed jobs that have dropped from the print queue as a result of an error. A failed job appears highlighted in red; you can double-click the job to display a more detailed error report.

## Selecting jobs

Selecting a job allows you to apply job management commands (from the Actions menu) to it.

---

### To select a job

- **In the Active Jobs window or in any panel of the Jobs window, click a job to select it.**

To select additional jobs in Command WorkStation, hold down Ctrl and click the desired jobs; to select a sequential series of jobs, hold down Shift as you click the jobs.

To select multiple jobs in Command WorkStation LE, hold down Shift and click additional jobs.

**Note:** To select multiple jobs, the jobs must be located in the same window and panel.

### Sorting job displays

You can sort jobs in the Active Jobs or Jobs windows by clicking the job ticket column headings.

---

#### To sort jobs

- **In the Active Jobs or Jobs windows, click the heading for the job ticket column that you want to use to sort jobs.**

For example, to sort jobs by status, click the Job Status column heading. The window sorts jobs according to their status.

To reverse the sorting order, click the column heading again.

### Customizing job ticket information

You can customize the display of job ticket information in the Active Jobs window and in all panels of the Jobs window by rearranging the column headings. You can tighten the columns, add new column headings, move columns, and delete column headings.

Job Status	Job Title	User	Date/Time	Copies	Size
------------	-----------	------	-----------	--------	------

You can customize job ticket information according to your workflow needs. For example, if you are monitoring multiple servers, you can add Fiery and Device columns to track the Fiery location of individual jobs.



In Command WorkStation, the information in the Date/Time column is based on the date and time settings of the Regional Settings control panel. You can access the Regional Settings control panel from the Start>Settings>Control Panel menu or Start>Control Panel menu (Windows XP/Server 2003 only) in the Windows taskbar.

---

### **To customize job ticket information for the Active Jobs or Jobs windows in Command WorkStation\***

- 1. Right-click the heading of a job ticket column.**
- 2. From the menu that appears, choose the options to display and the sequence in which you want to view them.**

**Add**—Adds one of the listed columns to the display at your mouse position. The submenu lists the headings that are not displayed.

**Move Left, Move Right**—Moves the selected column left or right.

**Delete**—Removes the selected column.

The Job Status (Active Jobs window only), Job Title, and User columns are required—all others are optional.

- 3. Adjust the column widths.**

Adjust the width of a column by clicking the column border in the heading and dragging left or right. You can change the column widths at any time.

---

### **To customize job ticket information for the Active Jobs or Jobs windows in Command WorkStation**

**LE†**

- 1. Control-click the heading of a job ticket column.**
- 2. Choose Edit Visible Columns from the menu that appears.**
- 3. In the List Editor dialog box, specify the job ticket columns that you want displayed.**

# 3

To add a column, select the column name in the list on the right and click Add. To remove a column, select the column name in the list on the left and click Remove.

**4. Click OK to apply your changes.**

**5. Adjust the placement of columns.**

Rearrange the placement of a column by dragging the column left or right.

**6. Adjust the column widths.**

Adjust the width of a column by clicking the column border in the heading and dragging left or right. You can change the column widths at any time.

## Managing job flow

The following sections describe the job management tasks you can perform with Command WorkStation and Command WorkStation LE.

### Importing jobs

Use the Import command to import jobs into the job flow. You can import jobs located anywhere in the connected network, or jobs previously archived to external devices.

For information on archiving jobs, see [page 3-94](#).

---

#### To import a job into Command WorkStation\*

- 1. Choose Import from the File menu, and then choose Job or Archived Job.**

The Select Files to Import dialog box appears.

- 2. Locate and select the job file to import and click Add.**

The job appears in the Files to be imported list. To import multiple jobs, select each additional job and click Add.

- 3. Choose the desired destination queue from the Logical Printer menu.**

A destination queue is available only if the administrator has enabled it in Setup (see the [Configuration Guide Chapter 3](#)).

If you choose Hold, the job is imported into the Active Jobs window and held for future action.

If you choose Print, the job is imported into the Active Jobs window and released for immediate printing.

# 3

## 3-76 Using Command WorkStation or Command WorkStation LE

If you choose Direct, the job is sent directly to the Fiery for printing. The job does not appear in the Active Jobs window or Printed Jobs panel.

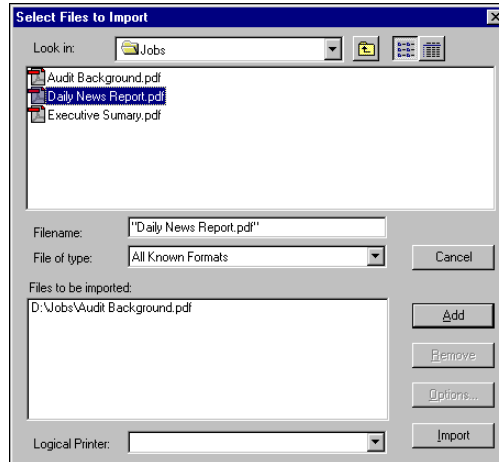

### 4. Click Import.

### To import a job into Command WorkStation LE†

1. Choose **Import** from the **File** menu, and then choose **Job** or **Archived Job**.
2. Locate and select the job file to import and click **Open**.



3. If the **Import Options** dialog box appears, specify the desired destination queue, and then click **OK**.

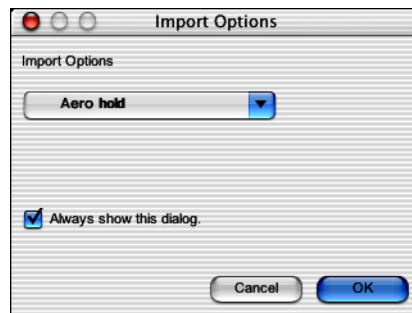

You can control the display of the Import Options dialog box by specifying the "Always show this dialog" option or setting the Show Import Options Dialog preference (see [page 2-57](#)).

A destination queue is available only if the administrator enabled it in Setup (see the *Configuration Guide Chapter 3*).

If you choose Hold, the job is imported into the Active Jobs window and held for future action.

If you choose Print, the job is imported into the Active Jobs window and released for immediate printing.

If you choose Direct, the job is sent directly to the Fiery for printing. The job does not appear in the Active Jobs window or Printed Jobs panel.

### Using job management commands

As the operator, you can issue the following job management commands from the Actions menu to release or hold selected jobs in the Active Jobs window and Printed Jobs panel:

- Print
- Process and Hold
- Print and Hold
- Remove Raster Data
- Hold

The availability of each command varies, depending on the context of the selected job. In addition to choosing these commands from the Actions menu, you can issue them from context-sensitive menus. Activate the Print, Hold, and Process and Hold commands using the Action buttons.

The following table describes job management commands in greater detail and explains how each command affects the raster data associated with a job:

<b>Choose this command</b>	<b>To do this</b>	<b>Raster data is</b>
Print	Prints the selected job in the Active Jobs window, Printed Jobs panel, FreeForm panel, or Archive panel.	Temporarily held on the Fiery until the job completes printing.
Hold	Holds the selected job waiting to process in the Active Jobs window, or the selected job in the Printed Jobs or Archive panel, and marks the job with either the spooled/held flag or the processed/held flag.	Held on the Fiery hard disk drive indefinitely, if raster data is included with job.
Process and Hold	Processes the selected job in the Active Jobs window, Printed Jobs panel, or Archive panel, and holds a copy of the job. The copied job is marked with the processed/held flag.	Held on the Fiery hard disk drive indefinitely.
Print and Hold	Prints the selected job in the Active Jobs window, Printed Jobs panel, or Archive panel, and holds a copy of the job. The copied job is marked with the processed/held flag.	Held on the Fiery hard disk drive indefinitely.
Remove Raster Data	Removes the raster data associated with the selected processed/held job in the Active Jobs window, or with the selected raster job in the Printed Jobs or Archive panel; leaves the original PostScript or PCL data in place.	Deleted.

## Viewing and overriding print settings

When logged in as Operator, you can view, override the user print settings, and print any held job in the Active Jobs window and the Printed Jobs panel. You can view and override print settings of jobs in the FreeForm panel. You can view print settings, and print jobs in the Archive panel.

Use the Job Properties dialog box to view the user Notes and Instructions fields included with jobs.

---

### To view and override print settings

- 1. To view and override print settings for a held job, select the job in the Active Jobs window or Printed Jobs panel.**

You can also select a job in the Archive or FreeForm panel to view print settings.

**Note:** In Command WorkStation, you can override print settings for multiple jobs at once. To select multiple jobs, Ctrl-click the jobs in the Active Jobs window or Printed Jobs panel.

- 2. Choose Properties from the Actions menu.**

The Job Properties dialog box appears. This dialog box displays all the job settings encoded by the PostScript printer driver that can be decoded by the Fiery. If you, as the operator, have not changed anything, these are the settings a user entered before sending the job.

In Command WorkStation, the Job Properties dialog box is virtually identical to the Fiery Printing tab of the Fiery printer driver. For more information on the features in the Job Properties dialog box, see the online help included with the Fiery printer driver.

**Note:** If you selected multiple jobs in Command WorkStation, the Job Properties dialog box has a different appearance.

In Command WorkStation LE, the print settings of a selected job appear in two columns.



# 3

## 3-81 Managing job flow

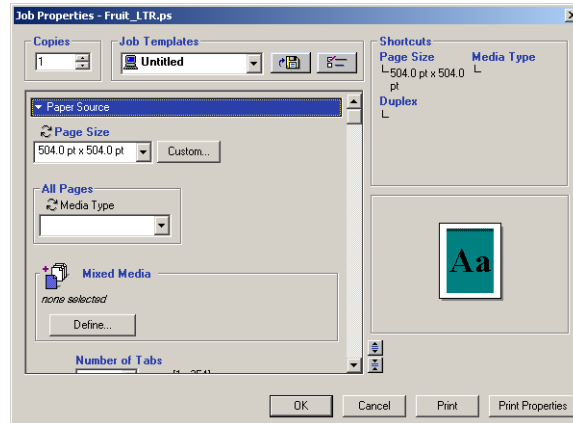

**Command WorkStation**

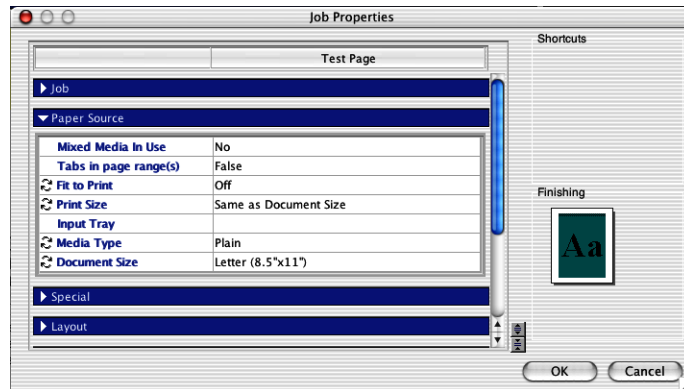

**Command WorkStation LE**

The user Instructions and Notes fields also appear in the Job Properties dialog box.

- Instructions fields are intended to be viewed and annotated by the operator, but their contents are associated with the job and are deleted when the job is deleted after printing.
- Notes fields can be viewed but not changed by the operator; their contents are transcribed to the Job Log just as the user sent them.

**Note:** Some print options available in the printer driver are not displayed in the Job Properties dialog box. For information about specific print options and settings, and where you set them, see Appendix A of the *Printing Guide*.

- To override a setting, expand the blue bar for a print setting category. In Command WorkStation, specify the desired setting. In Command WorkStation LE, click the current setting in the right column to display a menu of available settings, and choose the desired setting.**

In Command WorkStation, to override a setting for multiple jobs at once, Ctrl-click the setting name, and choose the desired setting.

**Note:** To retain a copy of the job with its original settings, duplicate the job and rename the duplicate *before* you change any settings.

**Note:** If an icon appears to the left of an option name, it indicates that changing the option's setting requires the job to be reRIPPed. When you override these types of options, the job is automatically reRIPPed for printing.

Indicates reRIPPING is required

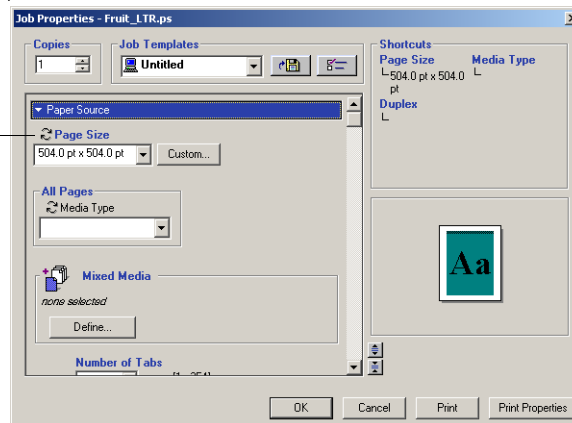

**Command WorkStation**

# 3

Indicates reRIPping is required

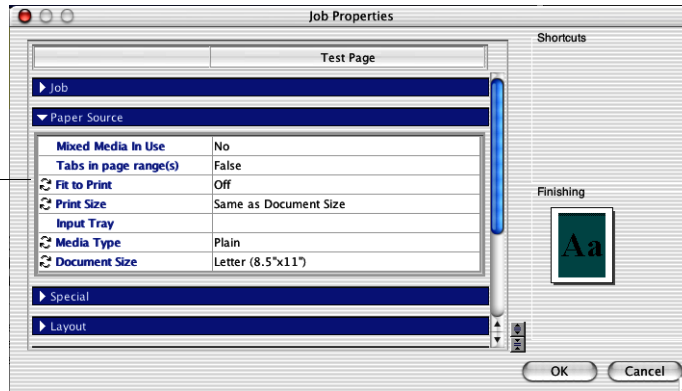

Command WorkStation LE

4. In Command WorkStation, to print the current list of print settings on a local printer, click Print Properties.
5. To apply the print setting overrides to the selected job, click OK.

## Reordering jobs\*

If you are logged in to Command WorkStation as an Administrator, you can reorder the priority of jobs that are waiting to process or print.

## To reorder job priority

1. In Command WorkStation, choose Reorder Jobs from the Server menu.

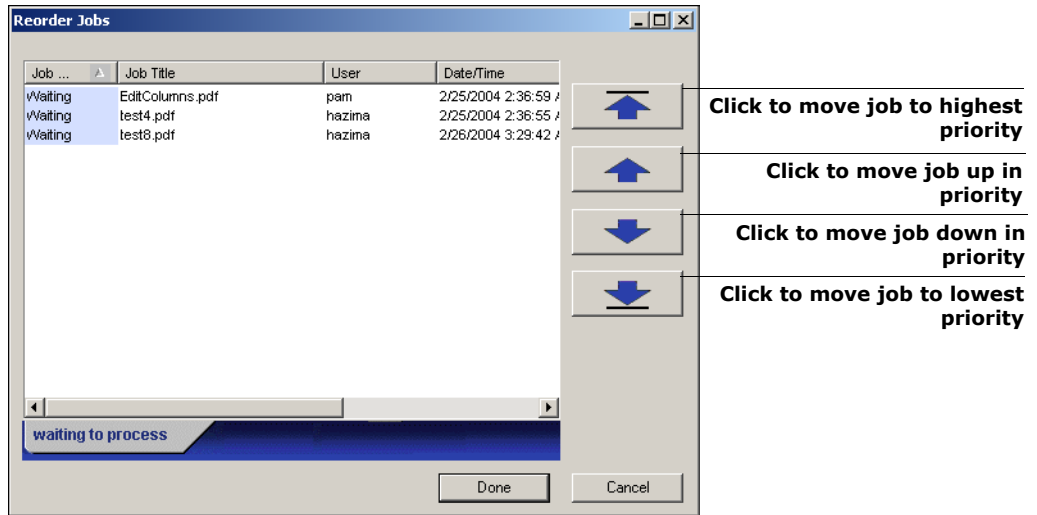

2. Click the tab that corresponds to the jobs that you want to reorder.  
You can only reorder jobs that are waiting to process.
3. Select the desired job in the list, and use the buttons on the right of the dialog box to reorder the job's priority.
4. Click Done when you are finished reordering the job priority.

## Managing jobs on multiple Fiery servers\*

Command WorkStation allows you to simultaneously connect to as many Fiery servers as your RAM resources allow. You can view and manage jobs processed by multiple Fiery servers from a single location and balance the job load between servers of similar capabilities.

- If you connect to multiple servers from Command WorkStation, you can easily switch between the All Servers view and the Selected Server view in the Active Jobs window, Jobs window, and Activity Monitor. For more information, see ["Monitoring single or multiple Fiery servers\\*"](#) on page 2-38.
- With servers that support the feature, use the "Send to" command to transfer jobs between servers.

For example, by viewing print jobs on all connected servers in the Active Jobs window, you can monitor the print load on each Fiery in your printing environment. If one Fiery has received a disproportionate number of jobs, you can balance the load by transferring some of these jobs to another, less active Fiery.

---

### To transfer a job between servers

1. **In the Active Jobs window, select any held job.**
2. **Choose Send To from the Actions menu, and select the Fiery to which you want to send the job.**
3. **Click Yes to confirm the transfer of the job.**

## Cancelling jobs

You may need to cancel a job after it has been routed for processing or printing. You can cancel a selected job only while it is being processed or printed. You cannot cancel a job that is waiting to be processed or printed.

- Cancelling jobs during processing—While a job is processing in the Active Jobs window, select the job and choose Cancel Processing from the Actions menu.

The name of the cancelled job is displayed in the Job Log.

- Cancelling jobs during printing—While a job is printing in the Active Jobs window, select the job and choose Cancel Printing from the Actions menu.

The name of the cancelled job is displayed in the Job Log.

**Note:** Cancelled jobs may be partially printed, and may include pages with one or more missing color plates, or pages that are completely blank.

- Pausing all jobs on the Fiery—Choose Suspend Printing from the Server menu to suspend the printing of all jobs on the Fiery. To continue printing jobs, choose Resume Printing from the Server menu.

## Defining Mixed Media settings\*

The Mixed Media feature allows you to define chapter divisions for a job, print ranges of pages on different weights of media, or insert blank media between pages. For more information, see Appendix a of the [Printing Guide](#).

**Note:** Inserted blank media between pages are not charged as printed pages.

---

**To define Mixed Media specifications\***

1. **In Command WorkStation, select a spooled/held job in the Active Jobs window, and choose Mixed Media Setup from the Actions menu.**

The Mixed Media dialog box appears. This dialog box lists any previously defined media settings and includes buttons for adding, modifying, and deleting settings.

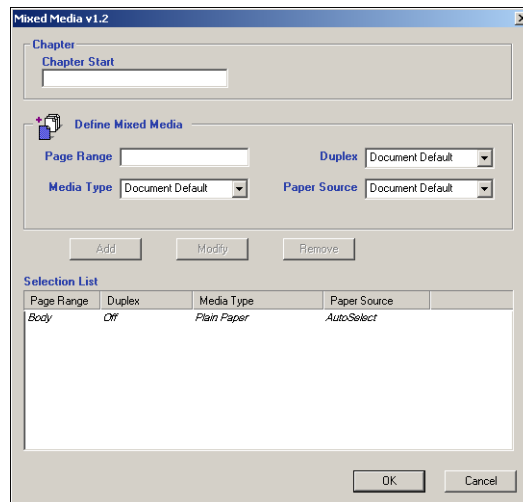

2. **In the Page Range field, enter page numbers or page ranges that should be printed on a distinct type of media.**

Pages and page ranges may be entered as comma-separated values (for example: 3,9–14,18). You can insert a blank page by placing a caret symbol before a page value (for example: 2,^7,9–16). For a duplex job, two pages are inserted when you place a single caret symbol.

3. **Choose the desired duplexing option for the page range from the Duplex menu.**
4. **Choose the desired media for the specified page range from the Media Type menu.**

To print pages on tab paper stock, choose True from the Tabs in Page Range(s) menu, and then choose Tab Stock from the Media Type menu. By default, tab printing is set to False.

By default, duplexing is set to Off.

- 5. Choose the source tray containing the specified media type from the Paper Source menu.**

- 6. Click Add to add the media specification to the Selection List. To remove a mixed media specification, select it and click Remove.**

Define and add more mixed media specifications as needed. Page ranges not specified as mixed media will print on the media defined by the Paper Source settings.

- 7. In the Chapter Start field, enter page numbers on which to start new chapter sections.**

Enter page numbers as comma-separated values (for example: 4,9,17) to designate the start of each new chapter. This feature forces each starting page to use a right-side page, adding a preceding left-sided blank, if necessary.

**Note:** It is not necessary to enter the first page, and page numbers refer to the numbering of the original document. If you use the Chapter Start feature, all media specified in the Paper menu per chapter must share the same dimensions (for example: all Letter, all Tabloid, or all A4).

- 8. Click OK.**

The Job Properties dialog box appears.

- 9. Click OK to close the Job Properties dialog box and apply the Mixed Media settings to the job.**



## Printing Fiery FreeForm variable data documents

The FreeForm printing feature provides a flexible and efficient method of printing variable data jobs, such as direct-mail advertising pieces. Fiery FreeForm allows users to preRIP and store the master elements of their variable data jobs on the Fiery, and then use that master data, as needed, for multiple variable data jobs.

**Note:**FreeForm is not available for PCL jobs.

The preRIPped master-element jobs are stored on the Fiery as FreeForm masters, and appear in the FreeForm panel of the Jobs window.

The ability to override job settings is especially important for variable data printing with Fiery FreeForm. Although the Fiery can store up to 100 FreeForm masters, users are limited to a range of 1 to 15 values that they can specify for the Create Master and Use Master print settings from the printer driver. To make use of all 100 available FreeForm Masters, the operator must override the Create Master and Use Master print settings from Command WorkStation or Command WorkStation LE.

**Note:**For any new Create Master or Use Master setting to take effect, the job must be reRIPped.

For background information on using the Fiery FreeForm feature, see the [Printing Guide Chapter 5](#).

## Creating and monitoring FreeForm masters

Users can assign FreeForm master numbers from 1 to 15 using the Create Master print option when they send a job. These numbers can be changed to a master number from 1 to 100, with job overrides from the Job Properties dialog box.

When the first 15 FreeForm master numbers have been used, users may inadvertently overwrite existing FreeForm masters by assigning what they think are new, unused FreeForm master numbers. When users choose a master number from the Create Master print option, an existing job using that master number is overwritten (the user receives a warning message that they are about to replace an existing job).

For this reason, the Operator should delete existing master jobs or reassign master numbers 1 through 15 to avoid any overwriting problems. Only the Operator can assign numbers from 16 to 100, enabling a high level of control over the FreeForm master numbers in use.

---

### To create a FreeForm master

- 1. In the Active Jobs window, select the held job comprising the master elements of the document.**
- 2. Choose Properties from the Actions menu.**
- 3. Scroll to FreeForm in the Job Properties dialog box.**
- 4. For the Create Master print setting, specify the FreeForm master number you want to assign to the job.**
- 5. Click OK.**
- 6. Choose Process and Hold from the Actions menu to assign the job a destination.**

Choose Print, or Print and Hold from the Actions menu for a hard copy of the FreeForm master.

# 3

After processing, the master job appears in the FreeForm panel of the Jobs window.

---

## **To delete a FreeForm master**

- 1. In the FreeForm panel, select the master job to delete.**
- 2. Choose Delete from the Actions menu.**

## Using FreeForm masters with variable data jobs

To print a variable data job with a particular FreeForm master, users must specify a number for the Use Master print setting. Users can only specify master numbers between 1 and 15. Only the operator can specify master numbers between 16 and 100, with job overrides from the Job Properties dialog box.

---

### To override the Use Master print setting

1. **In the Active Jobs window, select the held job comprising the variable elements of the document, and choose Properties from the Actions menu.**
2. **Scroll to FreeForm in the Job Properties dialog box.**
3. **For the Use Master print setting, specify the FreeForm master job to use as the master document.**
4. **Click Update (Command WorkStation) or OK (Command WorkStation LE).**
5. **In Command WorkStation, to display a preview of the specified master job, click Preview Master.**
6. **Click OK.**
7. **Choose Process and Hold, Print, or Print and Hold from the Actions menu to assign the job a destination.**

Particularly with a variable data job, Process and Hold the job so you can preview it before printing.

## Tips for using Fiery FreeForm

At sites where a small number of users print FreeForm jobs, the Operator may want to assign FreeForm master numbers to specific users, then let them monitor their own master numbers. Users can choose the Create Master print option to assign new masters or overwrite existing masters. They can also instruct the Operator to reassign master numbers (to a number greater than 15) for FreeForm masters they want available on the Fiery.

At sites where a large number of users print FreeForm jobs, the Operator may want to instruct users not to use the Create Master print option at all, but rather to send all their jobs to the Hold queue. In this case, the Operator can decide which FreeForm master numbers to assign before printing.

For all jobs sent to the Fiery, users should specify information (such as the desired FreeForm master number) to the operator using the Notes and Instructions fields in the Printer Job Notes dialog box.

**Note:** When specifying additional print settings for FreeForm jobs, certain print option settings must match for *both* the master and the variable job. Also, certain settings in the variable job override corresponding settings in the master job. For complete information on print settings in FreeForm jobs, see the [Printing Guide Chapter 5](#).

## Archiving jobs

You can archive PostScript and raster data jobs internally to the Fiery hard disk drive, or externally to the Command WorkStation or Command WorkStation LE hard disk drive or network drives. Once a PostScript or raster data job is archived, it appears in the Archive panel of the Jobs window.

You can issue the following Actions menu commands, described on [page 2-42](#), for jobs in the Archive panel:

- Print
- Delete
- Rename
- Hold
- Process and Hold
- Print and Hold
- Remove Raster Data
- Properties

---

### To archive a job

- 1. In the Active Jobs window, select any held job.**
- 2. Choose Archive from the Actions menu.**
- 3. To archive the job internally to the Fiery hard disk drive, click OK.**  
The job is archived internally and appears in the Archive panel of the Jobs window.

- To archive the job externally to the Command WorkStation or Command WorkStation LE hard disk drive or to a device on the network, click Add.**

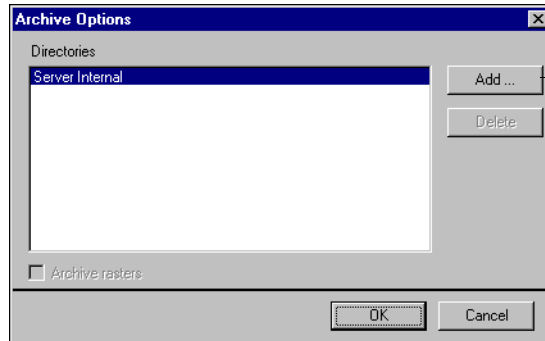

Click to add a device

- Browse to the device and folder to which you want to archive the job and click OK (Command WorkStation) or Choose (Command Workstation LE).**

The Archive Options dialog box displays external devices as available archive volumes.

- In Command WorkStation, if applicable, select Archive rasters in the Archive Options dialog box.**

The Archive rasters option is not available for PostScript data jobs and jobs archived to Server Internal.

**Note:** Large raster data files may take considerable time to archive.

- Select an archive volume and click OK.**

Archived jobs appear in the Archive panel of the Jobs window.

## Using the Job Log

The Job Log panel of the Jobs window displays a list of all the jobs processed or printed since the Job Log was last cleared.

You can adjust the column widths in the Job Log display by clicking the column border in the heading and dragging left or right (see ["Customizing job ticket information"](#) on page 3-72). You can also print the Job Log, export it to a tab-delimited text file, or clear it manually.

Using the Job Log Setup, the administrator can specify preferences to print the Job Log automatically every 55 jobs, or print and clear the Job Log automatically every 55 jobs. Periodically clearing the Job Log helps improve performance. The administrator can also choose the Job Log page size. For more information, see the [Configuration Guide](#).

**Note:** If a job was saved from the Imposition window of DocBuilder Pro with a new name and then printed, it appears in the Job Log with the name of the original job, *not* the new name.

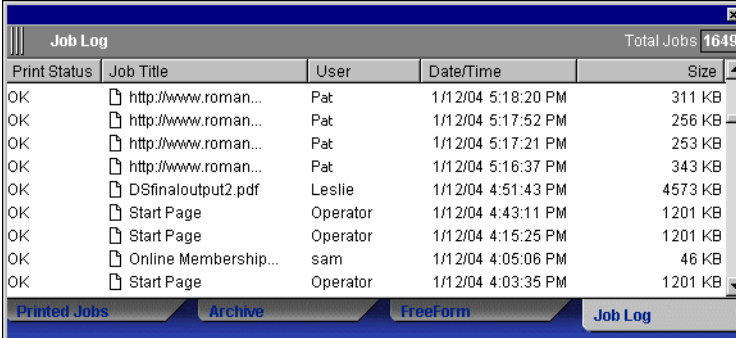

Print Status	Job Title	User	Date/Time	Size
OK	http://www.roman...	Pat	1/1 2/04 5:18:20 PM	311 KB
OK	http://www.roman...	Pat	1/1 2/04 5:17:52 PM	256 KB
OK	http://www.roman...	Pat	1/1 2/04 5:17:21 PM	253 KB
OK	http://www.roman...	Pat	1/1 2/04 5:16:37 PM	343 KB
OK	D\$finaloutput2.pdf	Leslie	1/1 2/04 4:51:43 PM	4573 KB
OK	Start Page	Operator	1/1 2/04 4:43:11 PM	1201 KB
OK	Start Page	Operator	1/1 2/04 4:15:25 PM	1201 KB
OK	Online Membership...	sam	1/1 2/04 4:05:06 PM	46 KB
OK	Start Page	Operator	1/1 2/04 4:03:35 PM	1201 KB

### To print the Job Log from Command WorkStation on a local printer\*

1. In Command WorkStation, choose **Print** from the **File** menu, and then choose **Job Log**.



The Print dialog box appears.

**2. Specify your local printer settings and click OK.**

**Note:** For information on how to print the job log from Command WorkStation LE, see ["Printing Fiery information pages"](#) on page 2-53.

---

### To export the Job Log

- 1. If it is not already displayed, click the Job Log tab on the Jobs window to open the Job Log panel.**
- 2. Click inside the Job Log panel to make it active.**
- 3. In Command WorkStation, choose Job Log from the Server menu, and then choose Export. In Command WorkStation LE, choose Export from the File menu, and then choose Job List or Job Log.**
- 4. Rename the file, if desired (the default name is job.log), specify a destination, and then click Save.**

The Job Log is exported to a tab-delimited text file. You can open the exported file using a spreadsheet, database, or word processing application.

---

### To clear the Job Log

- In Command WorkStation, choose Job Log from the Server menu and then choose Export and Clear. In Command WorkStation LE, choose Clear Job Log from the Server menu.**

**Note:** You can clear the job log only if you are logged in to the Fiery with Administrator privileges.

## Searching for jobs

The Find command allows you to search for and locate jobs on connected servers, using search parameters such as job file names or dates of creation. Use the Find command to search for jobs that appear in the Active Jobs window and in the Printed Jobs, Archive, FreeForm, and Job Log panels of the Jobs window.

In Command WorkStation, you can also perform advanced searches based on the file sizes and specific print options associated with jobs. You can save any set of general or advanced search parameters as a Find template, which you can reuse to perform the search again.

## To search for jobs

### 1. Choose Find from the Edit menu.

The Find dialog box appears.

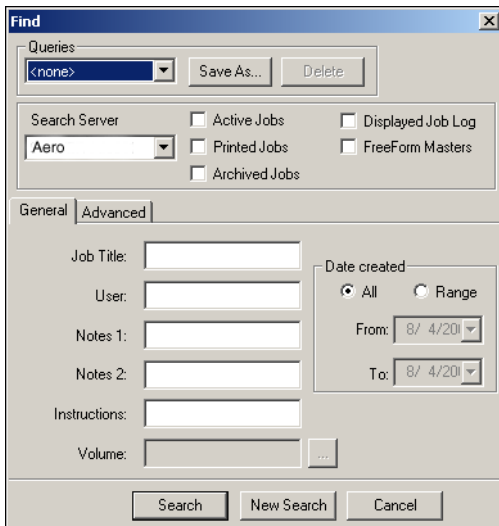

Command WorkStation

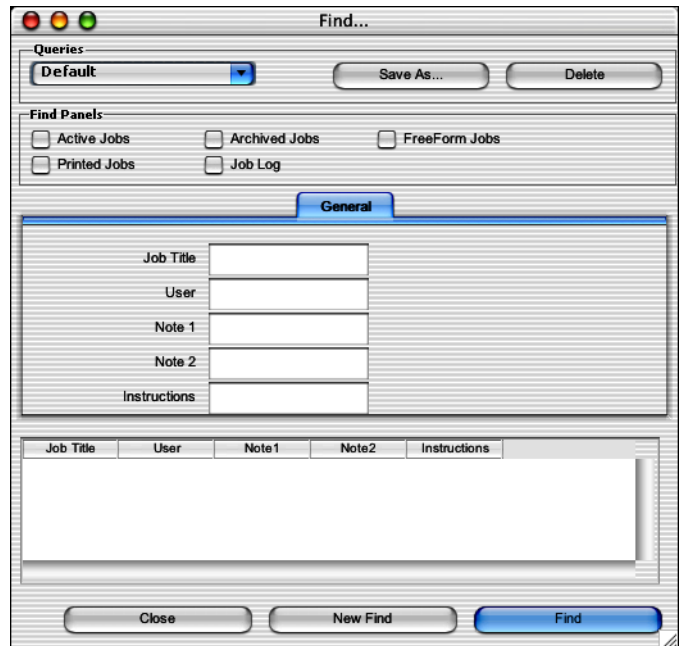

Command WorkStation LE

2. In Command WorkStation, choose a specific Fiery, or all Fiery servers from the Search Server list.
3. Select one or more areas where you want to search for jobs.

You can search for jobs in the Active Jobs window and in the Printed Jobs, Archive, FreeForm, and Job Log panels of the Jobs window.

**4. Click the General tab, and specify parameters for the search.**

**Note:** To clear all fields in the Find dialog box at any time, click New Search (Command WorkStation) or New Find (Command WorkStation LE).

You can specify any or all of the following general search parameters. Available search parameters vary, depending on the areas selected for the search.

**Job title**—Enter the file name of the job.

**User**—Enter the name of the user who sent the job.

**Notes 1, Notes 2**—Enter text that appears in the Notes fields of the job.

**Instructions**—Enter text that appears in the Instructions field of the job.

**Volume\***—Specify the archive drive volume you want to search. This option is available only when you are searching for archived jobs.

**Date created\***—To search through all jobs, regardless of their creation date, select All. To restrict your search to jobs created on a certain date or range of dates, select Range. Use the From and To menus to specify start and end dates.

**5. Click Search (Command WorkStation) or Find (Command WorkStation LE) to find jobs that meet the specified search criteria.**

The Search Results window (Command WorkStation) or Find dialog box (Command WorkStation LE) lists found jobs.

In Command WorkStation, you can customize the appearance of the Search Results window in the same manner as the Active Jobs and Jobs windows. For example, you can display jobs on all connected Fiery servers or on a selected Fiery (see [page 2-38](#)), and you can customize the job ticket information (see [page 3-72](#)).

In Command WorkStation LE, you can customize the display of found jobs by resizing or rearranging the job ticket columns (see [page 3-73](#)).

---

### To perform an advanced search for jobs\*

**Note:** The Advanced search feature is available for Command WorkStation only.

**1. Choose Find from the Edit menu.**

The Find dialog box appears.

**2. Choose an option from the Search Server menu to search for jobs on a specific Fiery, or all connected Fiery servers.**

**3. Select one or more areas to search for jobs.**

Search for jobs in the Active Jobs window and in the Printed Jobs, Archive, FreeForm, and Job Log panels of the Jobs window.

**4. Click the Advanced tab.**

The Advanced tab of the Find dialog box includes an area for specifying file size search parameters. The Advanced tab also contains a list of all the print options associated with jobs on the server or servers specified by the Search Server setting.

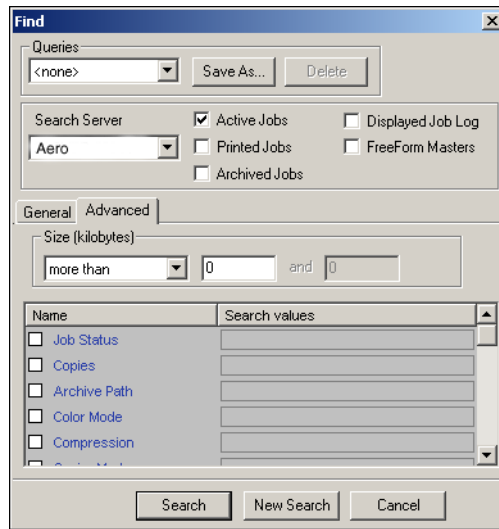

**To search for jobs that fall within a particular range of file sizes, choose a range option from the Size (kilobytes) menu. Enter the range values in one or both of the fields.**

**To search for jobs that have certain print options, click the selection box for each desired print option in the list.**

To specify additional search values for a selected option, right-click the field next to the option name and enter the desired values.

If you select multiple print options, Command WorkStation searches for jobs that include *all* the selected options. For example, if you specify a stapling and a punching option for your search, Command WorkStation only finds jobs that have both stapling and punching specified.

**Note:** To clear all fields in the Find dialog box at any time, click New Search.

**5. Click Search to find the jobs that meet the specified search criteria.**

The Search Results window lists the found jobs.

---

### To save the current set of search parameters as a Find template

1. **In the Find dialog box, specify the desired search parameters, as described in previous procedures.**

2. **Click Save As.**

A dialog box prompts you to name the template.

3. **Enter a name for the new Find template and click OK.**

Saved templates appear in the Queries menu. To remove a template from the menu, select the template and click Delete.

In Command WorkStation, saved templates are stored in the folder location you specified in the Preferences dialog box (see [page 2-56](#)).

---

### To reuse a Find template

1. **In the Find dialog box, choose the desired template from the Queries menu.**

The dialog box is automatically populated by the search parameters associated with the template.

2. **Click Search (Command WorkStation) or Find (Command WorkStation LE) to begin searching for jobs.**

## Chapter 4: Previewing and Manipulating Jobs

The Preview windows of Command WorkStation and Command WorkStation LE allow you to display preview images of jobs and perform edits, such as adding, deleting, duplicating, and reordering pages. You can also merge pages from two different jobs into a single, merged job.

**Note:** The viewing, editing, and merging features of the Preview windows are not available for PCL files or any job sent with the PCL printer driver.

**Note:** DocBuilder Pro allows you to use additional preview and edit features. For more information, see [page 5-114](#).

**Note:** Unless otherwise specified, information in this chapter applies to both Command WorkStation and Command WorkStation LE. In cases where the two applications are nearly identical, only Command WorkStation illustrations are shown.

### Previewing jobs

Use the Preview windows to preview pages of selected jobs.

#### Displaying thumbnail previews

When you select a job and choose Preview from the Actions menu, a preview window opens, displaying thumbnail images of the selected job.

**Note:** Thumbnail previews are not designed to display color accurately.

### To view thumbnails of a job

1. In Command WorkStation, select a processed/held job in the Active Jobs window, or select a FreeForm master job in the FreeForm panel. In Command WorkStation LE, select a processed/held job in the Active Jobs window.

2. Choose Preview from the Actions menu.

Page thumbnails appear in the Preview window.

### Preview window controls

The following illustrations show the various controls (represented by icons) that are available in the Preview window. Each control is described in more detail elsewhere in this chapter.

#### Command

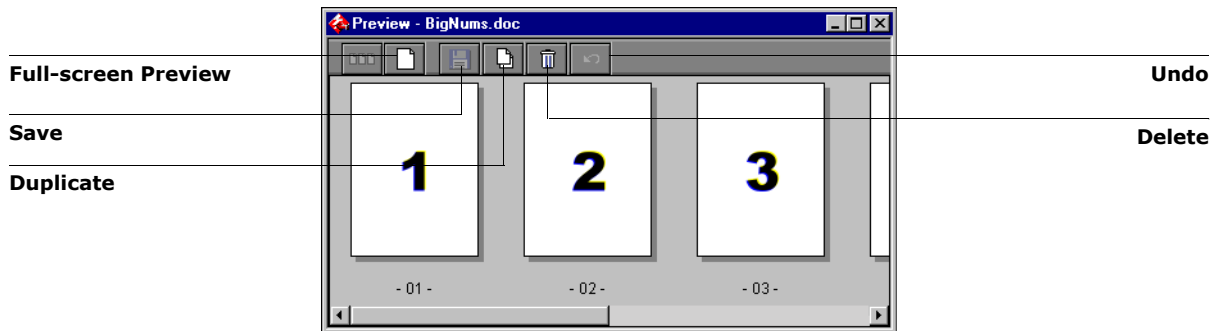

#### Command

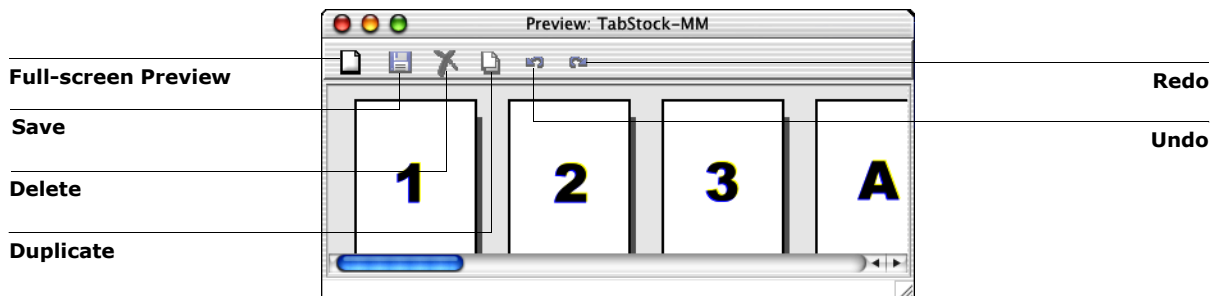



**Note:** In Command WorkStation, you can preview locked PDF files. When previewing a locked PDF file, the phrase "<Secure/Locked>" appears at the end of its filename and a lock icon appears in the upper right corner of the Preview window. You cannot edit locked PDF files.

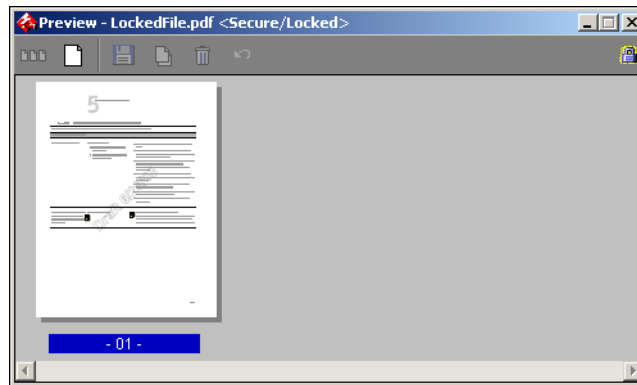

Lock icon

## Displaying full-screen previews

You can open a selected page in the Preview window as a full-screen image for a more detailed inspection.

**Note:** Full-screen previews are not supported for FreeForm jobs.

---

### To view a full-screen preview of a job

- **Select a page in the Preview window and click the Full-Screen Preview control (see [page 4-104](#)).**

**Note:** The full-screen preview may take a few moments to open. The full-screen preview window is independent of Command WorkStation or Command WorkStation LE and may appear behind the application on the screen. Bring the full-screen preview window to the front, if necessary.

# 4

## 4-106 Previewing and Manipulating Jobs

### Command WorkStation

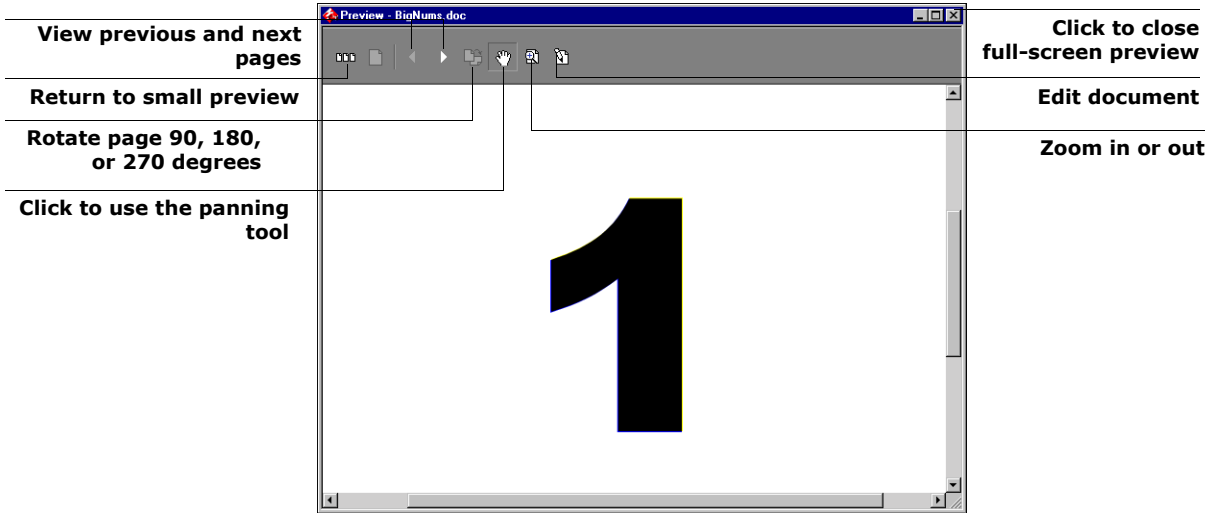

### Command WorkStation LE

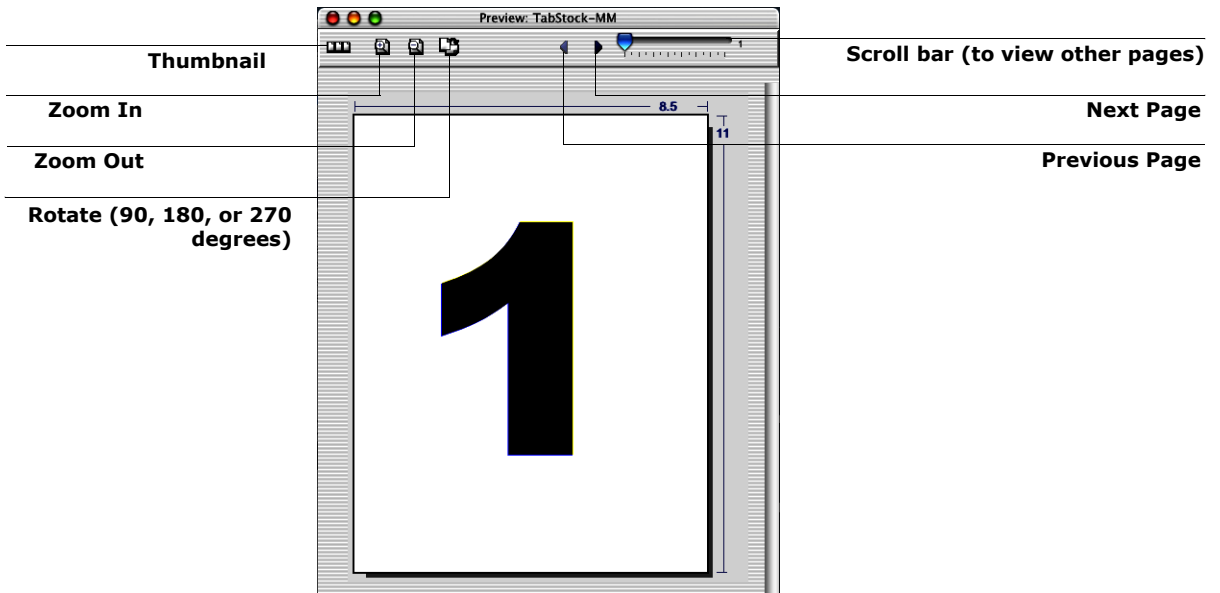

Use the controls (represented by icons) in the full-screen preview to change the zoom level, rotate the page, display other pages, or return to the thumbnail preview.

## Editing and merging jobs

Use the Preview windows to reorder and edit the pages of a job, or merge pages from several jobs into a single job.

### Editing jobs

The Preview window includes controls that allow you to make page-level edits to a job.

---

#### To edit a job

- 1. In Command WorkStation, select a processed/held job in the Active Jobs window, or select a FreeForm master job in the FreeForm panel. In Command WorkStation LE, select a processed/held job in the Active Jobs window.**

- 2. Choose Preview from the Actions menu.**

The Preview window opens, displaying thumbnails of the pages in the job.

- 3. Select the pages you want to edit.**

Shift-click to select multiple, sequential pages; Ctrl-click (Command WorkStation) or Command-click (Command WorkStation LE) to select multiple, non-sequential pages.

- 4. Apply the desired edits.**

To apply edits to the selected page, click any of the controls that appear under the title bar of the Preview window (for an illustration, see [page 4-104](#)):

**Full-Screen Preview**—Opens a full-screen preview of the selected page (see [page 4-105](#)). The full-screen preview allows you to rotate the selected page.

**Duplicate**—Duplicates the selected page.

# 4

**Delete**—Deletes the currently selected page.

**Undo**—Reverses recently performed edits.

**Redo**—Reapplies recently performed edits. This control is available for Command WorkStation LE only.

- 5. To move pages within the Preview window, click to select the pages, and hold down the mouse button as you drag the selected pages to the new location.**

Shift-click to select multiple, sequential pages; Ctrl-click (Command WorkStation) or Command-click (Command WorkStation LE) to select multiple, non-sequential pages. Release the Shift, Command, or Ctrl key before moving the pages. If you move the pages on top of existing pages, the pages are overwritten.

In Command WorkStation LE, a blue vertical line indicates the destined location of the page you are dragging.

In Command WorkStation, the following icons indicate the result of your action. If the icon does not have an arrow, existing pages are overwritten and replaced by dragged pages; if the icon has an arrow, the dragged pages are inserted.



**Replace single page**



**Replace multiple pages**



**Move single page  
between two pages**



**Move multiple pages  
between two pages**



**Move single page  
before first page**



**Move multiple pages  
before first page**



**Move single page  
after last page**



**Move multiple pages  
after last page**

6. When you finish making edits, click the **Save** control (see [page 4-104](#)) to save the job.
7. Enter a new name for the editing job and click **Yes (Command WorkStation)** or **Save (Command WorkStation LE)**.

## Merging jobs

Merging allows you to combine documents from different sources into a single file. For example, you can combine covers and chapter head pages created in a page layout application with text pages created in a word processing application. Or, you can customize a slide presentation by inserting slides from a different presentation.

**Note:** When printing a merged job, Command WorkStation or Command WorkStation LE generally gives priority to the print settings of the original jobs over those of the merged job. Before merging two jobs, make sure that both jobs have been processed using the common print settings desired for final output. For example, to create a merged job that prints to duplexed pages, make sure both original jobs have been processed with the duplex setting enabled. Overriding the print settings of a merged job can produce unexpected results and is not recommended.

---

### To merge pages from two different jobs

- 1. Select a job, and choose Preview from the Actions menu.**
- 2. Select another job, and choose Preview from the Actions menu.**  
The job is displayed in another Preview window.  
**Note:** To merge pages, both jobs must reside on the same Fiery.  
**Note:** In Command WorkStation LE, choose Cascade Preview Windows or Tile Preview Windows from the Windows menu to display preview windows in the foreground.
- 3. In the source document Preview window, click to select the pages, and hold down the mouse button as you drag the selected pages to the new location in the destination document Preview window.**

# 4

## 4-111 Editing and merging jobs

### Command WorkStation

Source doc. preview

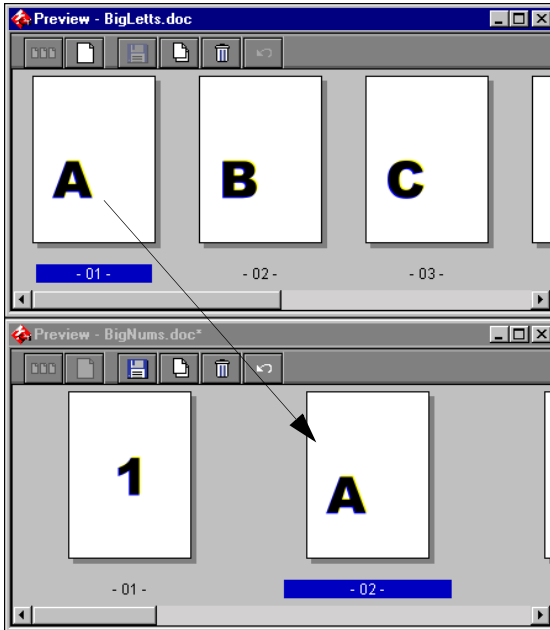

Destination doc. preview

### Command WorkStation LE

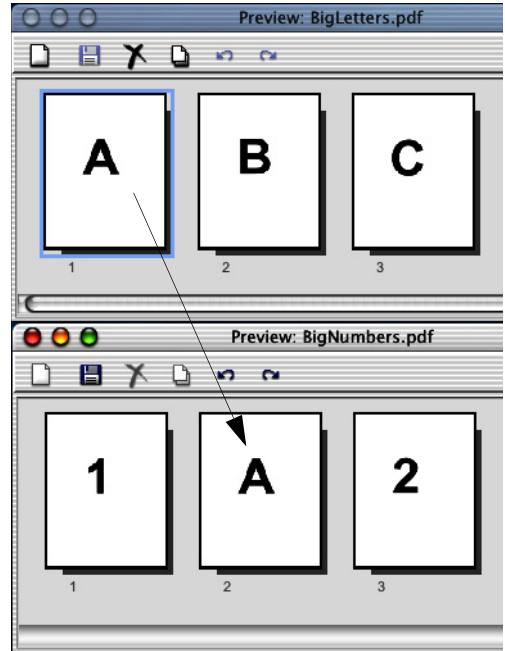

Use the following tips and guidelines:

- Shift-click to select multiple, sequential pages; Ctrl-click (Command WorkStation) or Command-click (Command WorkStation LE) to select multiple, non-sequential pages. Release the Shift, Command, or Ctrl key before moving the pages.
- To add pages, drag the pages to a new position between pages, before the first page, or after the last page in the first Preview window. Moving the selection to the left or right of a page places the selection in that location and rennumbers the pages.
- To replace pages in Command WorkStation, drag the second preview pages on top of pages in the first Preview window. Moving the selection over an existing page replaces the existing

page with the one you are moving. To replace pages in Command WorkStation LE, you must manually delete the unwanted pages.

- In Command WorkStation, the cursor changes to reflect the result of your action:
- In Command WorkStation LE, a blue vertical line indicates the destined location of the selection you are dragging.
- Multiple levels of undo are available; use the Undo control to undo all the way back to your first edit. There is a Redo control in Command WorkStation LE.

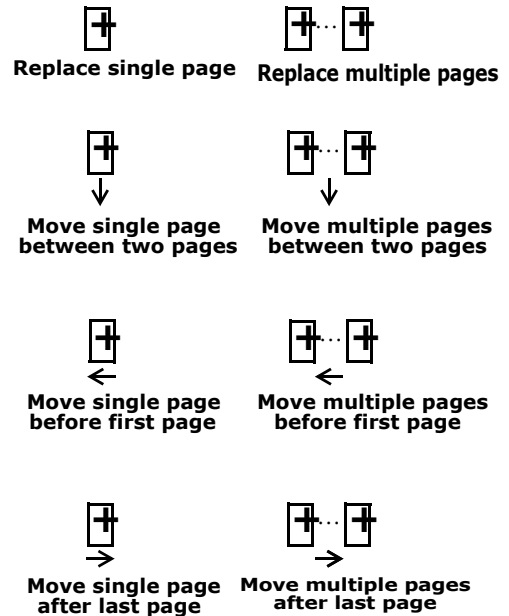

**Note:** After you drag pages from one Preview window to the other, the first window is designated as the source, and the other window the destination. During a merging session, you can drag pages only from the source window to the destination window, not vice versa. To merge pages in the opposite direction, you must save your current changes to the destination window and begin a new merging session.

- To merge additional pages from another source job, open a new job (resident on the same Fiery) in a Preview window.**  
Repeat step 3 to merge pages from the new source job.
- When you have finished merging pages, click the Save control (see [page 4-104](#)).**
- Enter a new name for the merged job, and click Yes (Command WorkStation) or Save (Command WorkStation LE).**



# 4

## 4-113 Editing and merging jobs

**Note:** When multiple users are connected to the Fiery via a job management utility, only one user should make changes at a time. If multiple users make changes in the same job simultaneously, unexpected results may occur.

## Chapter 5: Using DocBuilder Pro

The DocBuilder Pro option allows you to apply imposition layouts to jobs for special printing and binding needs. DocBuilder Pro also provides several enhancements to the previewing, editing, and merging features of Command WorkStation.

For background information on using imposition, see [Appendix A](#). For information on customizing imposition settings, see [Chapter 6](#).

**Note:** DocBuilder Pro is available as an optional upgrade for Command WorkStation. For more information, contact your authorized service/support technician.

**Note:** DocBuilder Pro is not supported for Command WorkStation LE.

### Previewing, editing, and merging jobs

With the DocBuilder Pro option, you can use the Preview windows of Command WorkStation to preview, edit, and merge PostScript and PDF jobs that have been spooled and held. You can apply all of the features discussed in [Chapter 4](#) to spooled/held jobs and processed/held jobs.

Detailed descriptions of the DocBuilder Pro enhancements to the Preview windows follow. When applicable, page number references to sections in other chapters are provided.

**Previewing jobs**—You can select any PostScript or PDF job showing a spooled/held (light yellow) status, and open the job in a Preview window (see [page 4-103](#)).

# 5

## 5-115 Previewing, editing, and merging jobs

When you preview a PostScript job, Adobe Acrobat automatically opens in the background, generating PDF thumbnails that allow you to preview the job and perform further edits, including merging. A message prompts you to accept conversion of the file to PDF.

When you open the full-screen preview for a spooled/held PostScript or PDF job, you have access to three additional preview controls, as shown in the following illustration.

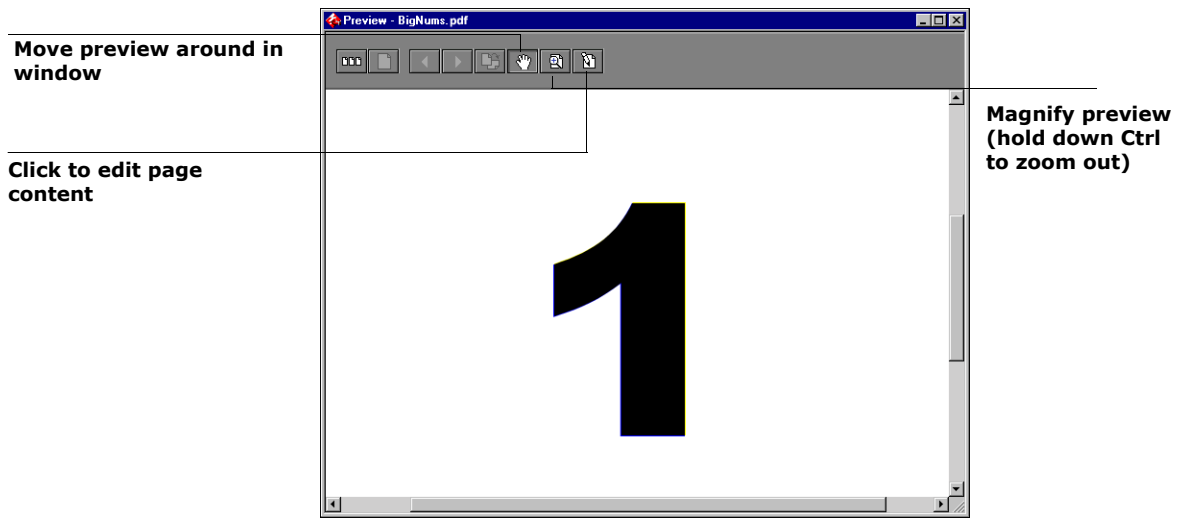

**Editing page content**—Edit the contents of a spooled/held page by opening its full-screen preview (see [page 4-105](#)), and using the Adobe Acrobat and Enfocus PitStop editing tools (see [page 6-148](#)).

**Merging jobs**—You can merge pages from several spooled/held jobs together in a new file (see [page 4-109](#)). To merge jobs, both jobs must have the same status; that is, both jobs must be spooled/held or processed/held.

**Inserting blank pages**—You can insert blank pages into a spooled/held PostScript or PDF job. First, open the job in a Preview window. Right-click a page thumbnail, and choose Blank Page from the menu. A blank page is inserted after the currently selected page.

## Imposition window

**Note:** The imposition feature is not supported for PCL jobs.

From the Imposition window, you can impose the pages of a document in an order and positioning suitable for printing and binding. If you are connected to more than one server at once, you can access the Imposition feature from one server only.

---

### To open a job in the imposition window

- 1. Send the desired job to the Hold queue.**

For information on using Command WorkStation, see Chapters [2](#) and [3](#).

- 2. Select the spooled/held job in the Active Jobs window, and choose **Impose** from the Actions menu. You can also right-click the job and choose **Impose** from the menu that appears.**

You can open a PostScript or PDF (Portable Document Format) file, but it must show a spooled/held job status.

**Note:** If you have installed the DocBuilder Pro option, you must install a dongle on your workstation. If the dongle is not attached, an error message appears. For more information, contact your authorized service/support technician.

To impose a processed/held job, select the job in the Active Jobs window and choose Remove Raster Data from the Actions menu to put the job in a spooled/held status. Then choose Impose from the Actions menu. To impose a printed job, select the job in the Printed Jobs window and choose Hold from the Actions menu.

When you choose the Impose command, a page-imaging process generates a PDF version of the job on which DocBuilder Pro performs imposition.

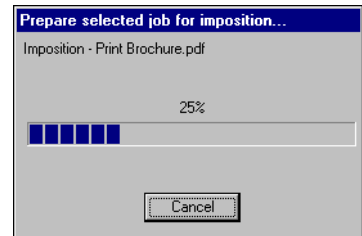

A status window appears while the job is imaged for the Imposition window.

When it opens, the Imposition window displays the job. No layout is applied unless the job has been previously imposed. Templates for common layouts are provided and can be invoked from the Imposition window, as described in ["Using templates"](#) on page 5-126.

## Job previews

The Imposition window provides a preview of a job's pages, allowing you to manipulate the source PDF.

Pages appear as a printer's spread; that is, they appear in the order in which they are printed as an imposed job. In contrast, a reader's spread shows pages in the order they are intended to be read. Note that the Preview windows in Command WorkStation image jobs as reader's spreads.

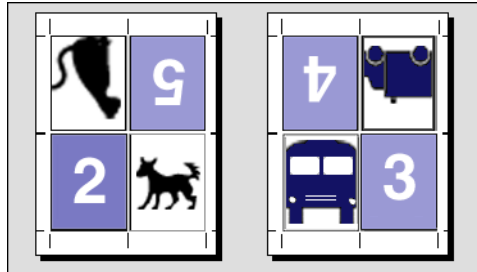

**Printer's spread**



**Reader's spread**

The paper used to print a printer's spread is known as a sheet. In duplex printing, each sheet has two imageable surfaces—one on the front side and one on the back side of the sheet. Each imageable surface contains one printer's spread.

## Navigating in the Imposition window

Use the icons and menus at the top and bottom of the Imposition window to perform the following:

- Switch from Preview mode (thumbnails of actual content) to Layout mode (page numbers only).
- Switch between Mixed Page mode (document with varying page sizes) and Fixed Page mode (document with a single page size). For more information on Mixed Page and Fixed Page modes, see [page 6-129](#).
- Zoom in and out.
- Drag the job preview around to make a particular page or sheet surface visible.
- Go directly to a particular page or sheet surface.



# 5

## 5-121 Navigating in the Imposition window

The Zoom tool, Pan tool, Preview mode, Layout mode, Mixed Page mode, and Fixed Page mode buttons are located in the upper-right corner of the window.

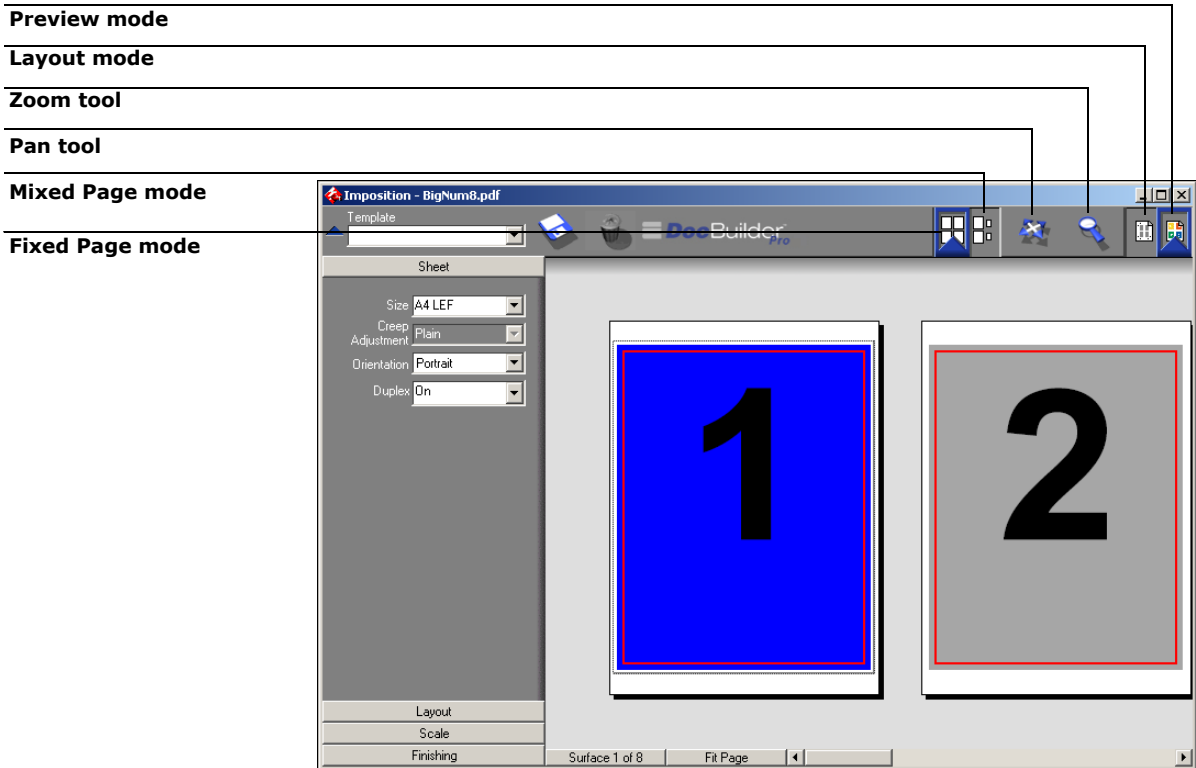

Selecting the Pan or Zoom tool changes the appearance of the cursor to indicate you can use that tool to manipulate the preview. When you choose Preview, Layout, Mixed Page, or Fixed Page mode, a blue border appears around the selected view, and the appearance of the job in the Imposition window changes immediately.

Imposition settings appear grouped in the Sheet, Layout, Scale, and Finishing panes at the left of the window. To expand or collapse a pane of settings, click the bar for that pane.

The Surface menu, View menu, and scroll bar appear at the bottom of the window. These menus and controls affect the display in the Imposition window immediately.

### Switching between page view and layout view

Use the view mode buttons to switch between a page view and a layout view of the job.

- **Preview mode**—approximates the appearance of the final printed output very closely; for this reason, it is sometimes called a WYSIWYG (“what you see is what you get”) preview.
- **Layout mode**—displays numbered, generic pages that allow you to determine the location of source document pages in the imposed job; you can rotate individual pages in a layout view.

Different viewing modes may display different sets of printer’s marks; for more information, see the following table.

**Note:** Preview mode puts more stress on your system’s processor than Layout mode. To improve performance on slower systems, perform most of your work in Layout mode, switching to Preview mode only when you need to see content.

In Layout mode, you can rotate individual pages on the sheet. For more information, see [“Rotating pages”](#) on page 6-149.

The following table summarizes the characteristics of the Layout and Preview modes:

Feature	Layout mode	Preview mode
Shows page content	No	WYSIWYG content view
Quick redraw on slower computers	Yes	No
Shows printer’s marks	Yes	Yes

Feature	Layout mode	Preview mode
Enable/disable printer's marks	Yes	Yes
Reorder pages	Yes	No
Rotate pages	Yes	No
Define gutter	Yes	No

## Setting magnification levels

Use the Zoom tool to increase or decrease the level of magnification in the Imposition window from 12% to 800%.

The View menu at the bottom of the window provides several ways to set the level of magnification to display the contents of the window. The View menu allows you to choose preset zoom values ranging from 50% to 800%. You can also choose to make the current preview fit in the window. In addition to preset zoom percents, you can specify a custom zoom value.

---

### To use the Zoom tool

1. Click the Zoom tool to select it.



Zoom tool

The cursor changes to a magnifying glass in the preview area of the Imposition window.

2. Position the magnifying glass cursor over a page and click to zoom in.

The magnifying glass cursor displays a plus sign (+) to indicate increased magnification of page views. Each time you click, the current magnification doubles, up to a maximum of 800%.

**3. Hold the Ctrl key and click to zoom out.**

Each time you click, the current magnification is reduced in half, down to a minimum of 12%.

**4. Right-click the page in the Imposition window.**

Select Zoom In or Zoom Out from the menu that appears. Zoom In doubles the current magnification, and Zoom Out reduces the current magnification by half.

---

### To use the View menu

- **Click the View menu and choose a zoom percent.**

To preview the entire surface, click the View menu and choose Fit Page.

**Note:**The View menu changes only the appearance of pages, not their actual content. To change the scaling of pages in finished output, change the Scale area settings.

---

### To specify a custom zoom value

1. **Click the View menu at the bottom of the Imposition window.**

The current zoom value appears in the Zoom dialog box.

2. **Specify a new zoom value.**

Enter a new zoom value or select a value from the menu.

3. **Click OK or press Enter to confirm the new value.**

The window reflects the change immediately.

### Viewing the sheets

Use the Pan tool to drag the entire preview around in the window. For example, if you are working with many pages on a large sheet, you can use this tool to drag a particular portion of the sheet into view.

At the bottom of the window, you can manipulate the content view using a standard scroll bar or the Surface menu. The Surface menu opens the Go To Surface dialog box, which allows you to specify numerically the surface to display in the preview area.

---

### To use the Pan tool

1. **Click the Pan tool to select it.**

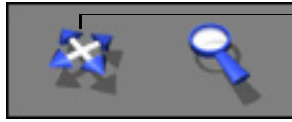

Pan tool

The cursor changes to a hand in the Preview area of the window.

2. **With the Pan tool cursor positioned over a sheet, click and hold the left mouse button while moving the mouse.**

The page preview moves in the same direction as the cursor. Repeat this step as necessary to make a particular portion of the preview visible.

---

### To use the surface menu

1. **Click the Surface menu at the bottom of the window.**

When the Go To Surface dialog box appears, the Surface field indicates the number of the sheet surface currently displayed.

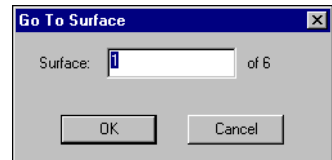

2. **Enter the number of the sheet surface to display.**
3. **Click OK or press Enter to go to the specified sheet surface.**

### Using templates

A saved group of imposition settings is known as a template. A template saves all current imposition settings, except custom rotations of individual pages on a finished sheet and the page size setting. You can apply any template to any job, making it easy to apply layout and printing settings quickly and efficiently.

DocBuilder Pro supplies built-in templates that define settings for commonly used layouts, such as 2-Up Saddle, 3-Up Trifold Brochure, 4-Up Gatefold, and so on. You can also create your own

# 5

## 5-127 Using templates

templates. For a complete listing of built-in templates, see [Appendix B](#). For information on creating your own templates, see ["Managing templates"](#) on page 6-152.

Both built-in templates and your own custom templates appear in the Template menu. You can apply a template by choosing its name from the Template menu, in the upper-left corner of the Imposition window. The new settings take effect immediately.

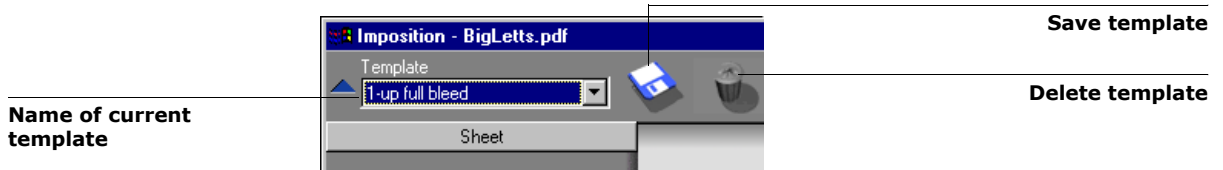

## Saving your work

It is important that you save the work you perform using the tools in the Imposition window.

---

### To save the imposed job

1. **Click the Close box in the upper-right corner of the Imposition window.**

If the job has changed since it was opened in the Imposition window, you are prompted to save it.



2. **In the Save As dialog box, type a name for the job and its settings.**

3. **Click Yes.**

In the Save As dialog box, the name of the original spooled source file appears with a new extension (.dbp).

If you mistakenly close the

Imposition window when you intend to keep working, click Cancel in the Save As dialog box. The original PostScript or PDF file remains intact, even after the converted file has been edited and saved in the Imposition window.

**Note:** When you rename an imposed file, you must include the .dbp extension. The extension is required to reopen the file with DocBuilder Pro.

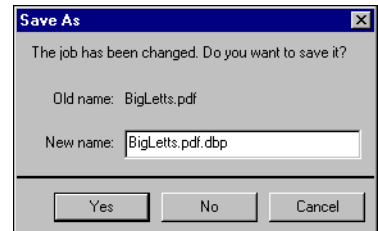

For more information on how files are saved to the server, see [“Saving imposed jobs”](#) on page 6-154.



## Chapter 6: Advanced Features of DocBuilder Pro

This chapter provides information about the advanced imposition and editing features of DocBuilder Pro. You can use imposition settings to alter various aspects of a job and create custom templates.

### Mixed Page mode and Fixed Page mode

DocBuilder Pro allows you to perform impositions in two different page modes. You can switch between page modes by clicking the corresponding icons at the top of the main imposition window.



**Fixed Page mode**—allows you to impose documents that contain pages that are all the same size.



**Mixed Page mode**—allows you to impose documents that contain pages of different sizes.

When you open the Imposition window for a document that contains different page sizes, Mixed Page mode is selected automatically; you cannot switch to Fixed Page mode. When you open the Imposition window for a document that contains a single page size, you can select either Mixed Page or Fixed Page mode.

Some imposition settings are available only for Mixed Page mode, and some only for Fixed Page mode. The following table notes the settings that are exclusive to either mode.

Settings panel	Setting	Available in Fixed Page mode	Available in Mixed Page mode
Sheet	Size	Yes	Yes
	Creep Adjustment	Yes	Yes
	Orientation	Yes	Yes
	Duplex	Yes	Yes

# 6

Settings panel	Setting	Available in Fixed Page mode	Available in Mixed Page mode
Layout	Rows/Columns	Yes	Yes
	Printer's Marks	Yes	Yes
	Printer's Marks: Pull into Page Edge	No	Yes
	Bleeds	Yes	No
Scale	Apply To	Not editable; always set to All Slots on All Surfaces	Editable
	Scale Mode	Available options: • Scale to Fit • Custom	Available options: • Scale to Fit • Custom
	Alignment/Offsets	No	Yes, unless Scale to Fit is specified
Finishing	Binding	Yes	Yes
	Gang Up	Yes	Yes

## Imposition settings

Imposition settings apply only to the job currently displayed in the main window. Because these settings usually affect the job's printed layout, they are saved with the job and used whenever the job is opened. For example, as you open jobs saved with different layouts, you see the display change accordingly.

Changes to imposition settings are applied to the current job immediately, but are not saved permanently until you save the job itself.

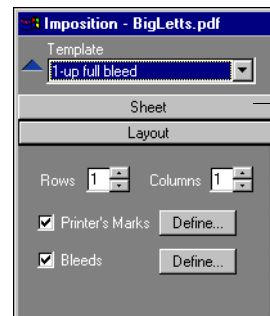

Click to view or hide the settings panel

# 6

## 6-131 Imposition settings

You can specify imposition settings using controls in the Sheet, Layout, Scale, and Finishing panes on the left side of the main window. To view or hide a settings pane, click the bar for that settings group.

**Note:** You can change the default unit of measurement for all input fields in the Command WorkStation Preferences dialog box. You can also specify any unit of measurement in any field that accepts input by adding one of the following abbreviations to the new value:

- "i," "in," or the inch symbol (") specifies inches, for example: 8.5 i, 8.5 in, 8.5"
- "mm" specifies millimeters, for example: 8.5 mm
- "pt" or "pts" specifies points, for example: 8.5 pts

### Sheet settings

Sheet settings allow you to specify characteristics of the paper on which the job is to be printed, such as dimensions, thickness, orientation, and whether it will be printed on one or both sides.

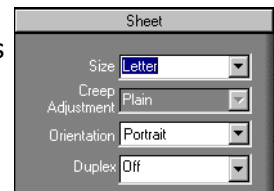

Because these settings affect virtually every other aspect of the imposition process, you should specify sheet settings immediately after opening a job in the main window. If necessary, you can change the settings later; the job is revised accordingly.

In general, experimentation with job settings does not cause permanent changes (or, potentially, loss of original job data), until the job is printed or saved with the new settings.

### Size

You can choose an item from the Size menu to specify the dimensions of a sheet of paper and see the change reflected in the

main window preview immediately. The Size menu includes items representing all page sizes defined by the currently selected printer's PPD file. To choose a custom size, enter the width and height of the custom page. If you do not specify units for your custom size values, DocBuilder Pro uses the default units specified in the Edit > Preferences dialog box.

When specifying a sheet size setting, consider the size of the final output. During imposition, DocBuilder Pro automatically scales pages, if needed, to fit the sheet's maximum imageable area. The area does not necessarily extend to the edges of the sheet. For example, if you perform 1-Up imposition of A4 8.5x11 pages onto A4 8.5x11 sheets, the final pages will be scaled smaller than A4 8.5x11. To retain your original page sizes, specify a sheet size large enough to accommodate the imposed pages without scaling.

### **Creep Adjustment**

Choose either Plain or Thick from the Creep Adjustment menu, or enter a value (between 0 and 2 inches, or the equivalent in another measurement unit) to specify the thickness of the sheet. When saddle-stitched binding is specified, DocBuilder Pro uses this value to compensate automatically for binder's creep (see ["Shingling and creep"](#) on page A-190).

**Note:** Even if you choose Thick from the Creep Adjustment menu, your job will still print on Plain paper, unless you specified Thick paper in the job properties. For more information on changing job properties from Command WorkStation, see ["Viewing and overriding print settings"](#) on page 3-14.

### **Orientation**

Use the Orientation menu to specify the orientation of a sheet. As an alternative to rotating the sheet, you can perform custom rotations on any page in the main window, as described in ["Rotating pages"](#) on page 6-149.

## Duplex

Use the Duplex menu to specify the relationship of content areas on opposing sides of a sheet. Specify On for duplex (two-sided) printing or Off for simplex (one-sided) printing.

When you choose On, the job is printed as duplex using a Top-Top setting, meaning that the tops of pages on opposing sides of a sheet are located on the same edge (usually the preferred choice for imposed book layouts).

## Layout settings

A layout is a plan that specifies the number, ordering, and rotation of page images on the sheet. DocBuilder Pro supports layouts of up to 25 pages per sheet, in a matrix of up to 5 rows by 5 columns (50 pages duplex). All

combinations of rows and columns allow gang printing; however, only Gang Up layouts in the 5x5 matrix support imposition.

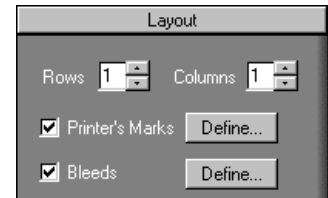

**Note:** If the number of pages in your job does not divide evenly into the number of rows and columns in the layout you select, you may see some sheets with blank spaces. The layout you select should correspond to the number of pages in your job.

## Rows

Click the Rows up and down arrows to specify the number of rows (up to five) in a layout, or specify the number of rows in the layout by typing a value in the Rows field. Changes to the Rows value are reflected immediately in the main window, whether you are in Layout or Preview mode.

The Rows value interacts with the Columns and Scale settings. When you choose a value that causes content to extend beyond the edge of the sheet, DocBuilder Pro provides a visual warning. See ["Clipping indicators"](#) on page 6-139.

When you change the Rows value, you are prompted with a message that all custom page edits (Add, Delete, or Duplicate) applied to the job are canceled.

### Columns

Click the Columns up and down arrows to specify the number of columns (up to five) in a layout, or specify the number of columns in the layout by typing a value in the Columns field. Changes to the Columns value are reflected immediately in the main window, whether you are in Layout or Preview mode.

The Columns value interacts with the Rows and Scale settings. When you choose a value that causes content to extend beyond the edge of the sheet, DocBuilder Pro provides a visual warning. See ["Clipping indicators"](#) on page 6-139.

When you change the Columns value, you are prompted with a message that all custom page edits (Add, Delete, or Duplicate) applied to the job are cancelled.

### Printer's Marks

Select Printer's Marks to add trim, fold, and job information to all sheets in a job. For background information on printer's marks, see [page A-185](#).

**Note:** Not all layouts display all of the Printer's Marks. For example, if the layout you select does not require that the sheet be folded, fold marks are not displayed, even if you selected them in the Define Marks dialog box.

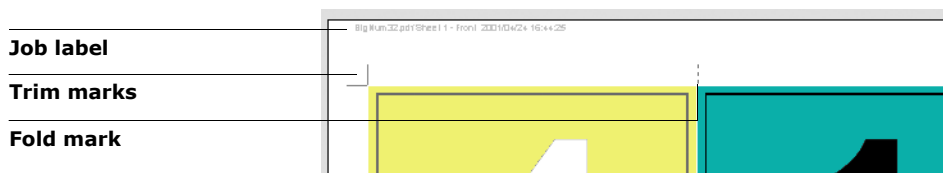

Because the set of marks required varies according to the job,

# 6

## 6-135 Imposition settings

DocBuilder Pro allows you to define the set of printer's marks displayed. For example, ganged-up business cards do not require fold marks, while a 4x4 book layout does. To specify which marks are shown, click Define and choose options in the Define Marks dialog box.

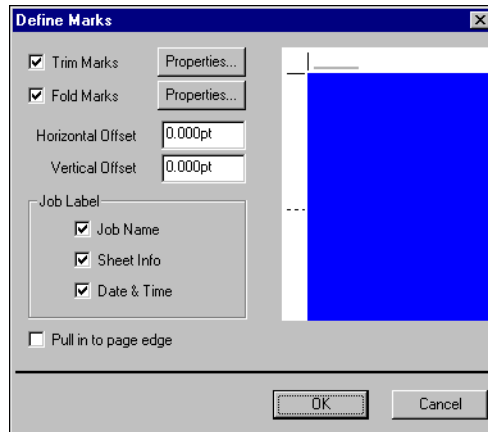

The Define Marks dialog box allows you to enable or disable trim marks, fold marks, and the individual elements of the job label. The job label stores descriptive text used for the job name, sheet information, and date and time. You can also enter values (from -72 to +72 points, -1.0 to 1.0 inch, or -25.4 to 25.4 mm) in the Horizontal Offset and Vertical Offset fields, to fine-tune the placement of trim marks and fold marks. In Mixed Page mode, you can select Pull in to Page Edge to align trim marks and fold marks with page boundaries.

**Offset**—The Horizontal Offset and Vertical Offset fields determine the gap between the printer's marks and the trim lines on the page. This allows you to move the

printer's marks away from the final trimmed area of the page. A

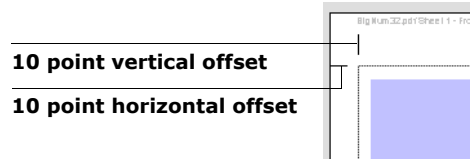

# 6

positive offset moves the printer's marks out from the center of the page, and a negative offset moves the printer's marks closer to the center of the page.

**Properties**—Click Properties to customize the appearance of trim marks and fold marks. You can specify the horizontal and vertical lengths of marks (from 1 to 216 points), type (dotted or solid), width (from 1 to 3 points), and color.

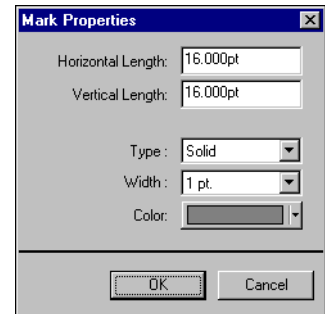

**Note:** The Printer's Marks option enables marks globally throughout a job. To disable or enable an individual mark, press the Ctrl key and click the mark directly in the imposition window. Disabled marks are indicated by an "X".

### Bleeds

The Bleeds option moves the trim marks into the image by the amount you specify to ensure

Ctrl-click to disable/  
enable mark

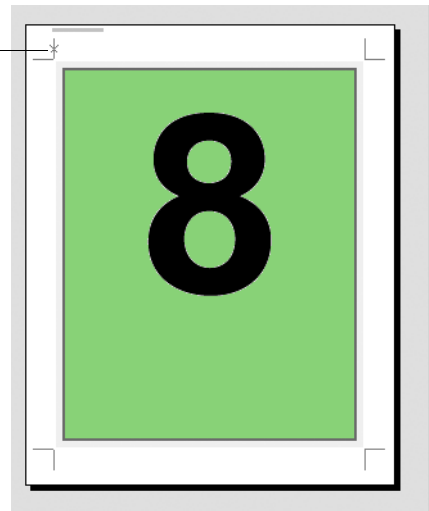

that the printed area extends beyond the edge of the trimmed



# 6

## 6-137 Imposition settings

sheet.

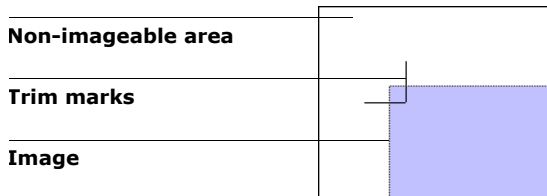

To specify horizontal and vertical bleed amounts for a job, click Define in the Layout panel and enter values (from 0 to 72 points, 0 to 1 inch, or 0 to 25.4 mm) in the Define Bleeds dialog box.

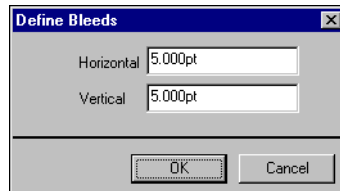

The Bleeds option is not available in Mixed Page mode.

**Note:** When you specify a bleed, you move the trim marks into the page by the bleed value on both the top and the bottom of the page, and on both sides of the page. Therefore, you reduce the size of your finished page by twice the bleed amount. If you plan on using bleeds, design your image to be slightly larger than the size of the final, trimmed page and select a larger paper size to accommodate trimming.

### Scale settings

Use Scale settings to enlarge or shrink the page by a specified amount.

# 6

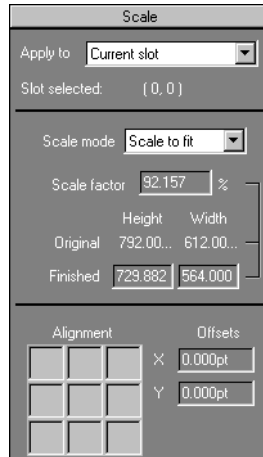

### Apply To

In Fixed Page mode, the scaling settings you specify are applied to all pages in a job.

In Mixed Page mode, you can apply scaling to specific slots on sheets. The number of slots on a sheet depends on the Rows and Columns values. The slot size is determined by dividing the maximum imageable area of the sheet by the number of slots.

**Current Slot**—Applies scaling to the currently selected page.

**Row on All Surfaces**—Applies scaling to all pages on all sheets that are located in the same row as the currently selected page.

**Columns on All Surfaces**—Applies scaling to all pages on all sheets that are located in the same column as the currently selected page.

**All Slots on All Surfaces**—Applies scaling to all pages in the job.

### Scale Mode

Choose a scaling option from the Scale Mode menu:

**Scale to Fit**—Scales page(s) to best fill the slot without printing past its edge. Scale to fit is the default mode.

# 6

## 6-139 Imposition settings

**Custom**—Enables the Scale Factor and Finished Height and Width fields, so that you can specify new scaling values. The original height and width values are displayed for your reference. When you specify a value, DocBuilder Pro automatically updates the other fields to preserve the height-to-width aspect ratio of the page.

### Clipping indicators

If you supply scaling values that would cause the page to print past the edge of the sheet, DocBuilder Pro provides a visual warning. When the window is in Layout mode, any clipped page edge is highlighted in yellow. When the window is in Preview mode, the Clipping icon appears to the left of the Scale Factor field. In addition, the appearance of the page preview itself makes scaling problems obvious—content truncates at the edge of the preview sheet, just as it would on a printed sheet.

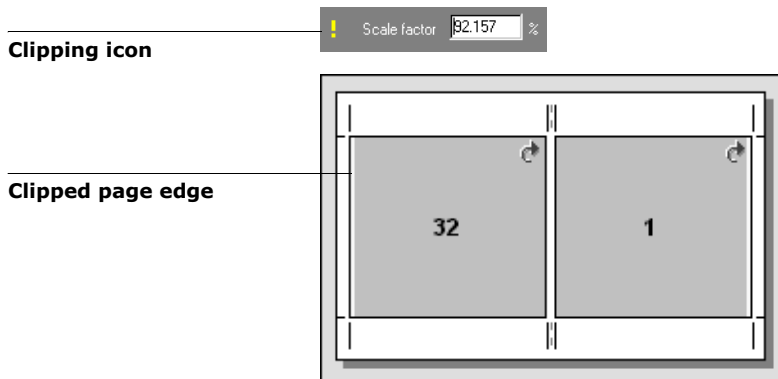

### Alignment and Offsets

The Alignment and Offsets settings are enabled when you choose Custom from the Scale Mode menu in Mixed Page mode. You cannot change Alignment and Offsets settings in Fixed Page mode.

# 6

The Alignment controls allow you to specify the placement of a page within its predefined slot on the sheet. For example, if the page has been scaled smaller than the slot, you can align the page to the upper-left corner of the slot by clicking the Alignment control corresponding to that position.

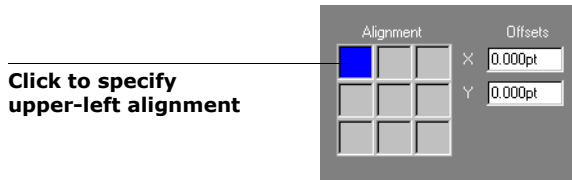

Click to specify upper-left alignment

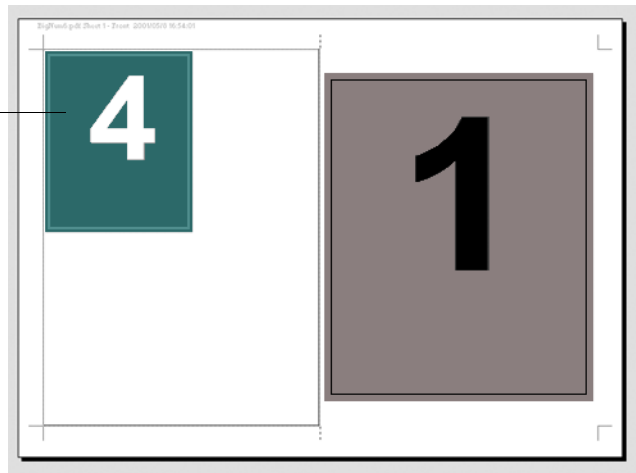

Page is aligned in slot

You can fine-tune the placement further by entering values (from -5184 to +5184 points) in the Offsets fields. Offset values are calculated in reference to the alignment position, and reset to zero when you specify a new alignment.

### Finishing settings

In the Finishing pane, you can specify binding and gang printing

settings.



### Binding

To enable binding settings and disable gang printing, select Binding. When binding settings are enabled, you can specify the binding method, the binding edge of each page (left or right), and the number of pages per saddle group. DocBuilder Pro compensates automatically for binder's creep according to the specified binding method, the number of pages in a saddle group, the layout in use, and the size of the job.

**Note:** If you are using a layout with more than two columns or rows, the Binding selection is unavailable.

You can specify the following binding edge options:

**Left Edge**—Specifies binding across the left edge of the booklet. The booklet reads from left to right.

**Right Edge**—Specifies binding across the right edge of the booklet. The booklet reads from right to left.

You can specify any of the following binding methods:

**Saddle**—Specifies a group of folded sheets stitched or stapled on a common, centered fold line. Saddle-stitched binding is the most common type of binding, and is usually used for booklets.

**Perfect**—Specifies signatures folded and stacked for binding. The spine edges are trimmed and glued together.

**Nested Saddle**—Specifies a combination of saddle and perfect

binding methods. As with saddle stitching, pages are grouped together and stapled or stitched across a common center fold. The saddle groups are then stacked one on top of another and glued, as with perfect binding.

When imposing a book for nested saddle binding, specify the number of pages in each saddle group by entering a value in the Groups of field. As the number of pages in a saddle group increases, the effect known as binder's creep becomes more prevalent (see [page A-190](#)). DocBuilder Pro shifts images on the page to compensate automatically for creep, according to the value in the Groups of field, the value in the paper thickness field, the specified binding type, and the ordering and orientation of pages specified by the current layout.

### **Gang Up**

To enable gang printing and disable binding settings, select Gang Up. In gang printing, you place multiple pages on a sheet for "collate and cut" finishing, rather than having DocBuilder Pro impose them in the order required by a particular binding method.

A collate and cut layout reorders pages in a manner that causes them to fall into easily collated stacks when the sheets in the job are cut into individual pages. The use of such a layout may allow multiple small jobs to be printed on a single sheet; thus, gang printing is commonly used as a means of saving paper when printing small jobs on printers that use large sheets, and when printing jobs such as business cards or labels.

To disable gang printing and enable binding settings, select the Binding setting. When gang printing is disabled, DocBuilder Pro imposes pages in the order defined by the current layout.

You can specify any of the following Gang Up methods:

**Repeat**—Places multiple copies of a page until the sheet is filled; for example, when printing both sides of a sheet, the front side of

# 6

## 6-143 Imposition settings

the first sheet is filled with images of Page 1, and the back side is filled with images of Page 2; the front side of the second sheet is filled with images of Page 3, and the back side is filled with images of Page 4; and so on, until all pages in the job are imaged.

Documents laid out in this order may tend to be collated more easily than when printed in another order. The Repeat option enables what is commonly known as “step-and-repeat” printing. Step and repeat is most often used when printing multiple copies of a single document; for example, when printing business cards, you print multiple copies of the same image to fill a larger sheet.

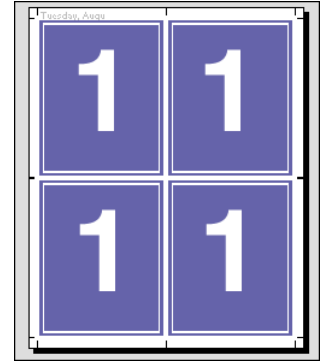

**Unique**—Places pages in an arrangement that is often more appropriate for printing a single copy of a job. This option does not fully collate itself (hand collating is necessary), but optimizes the sheet size while limiting the run to a single copy.

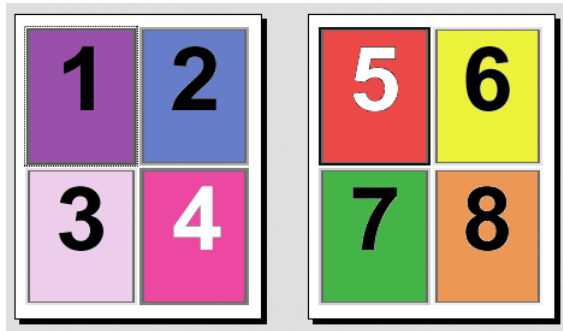

**Unique-Collate Cut**—Places pages in an arrangement that allows the pages to fall into the correct order when the sheets are stacked and cut. This option minimizes the need for collating by hand and is most appropriate for printing single copies of a document.

# 6

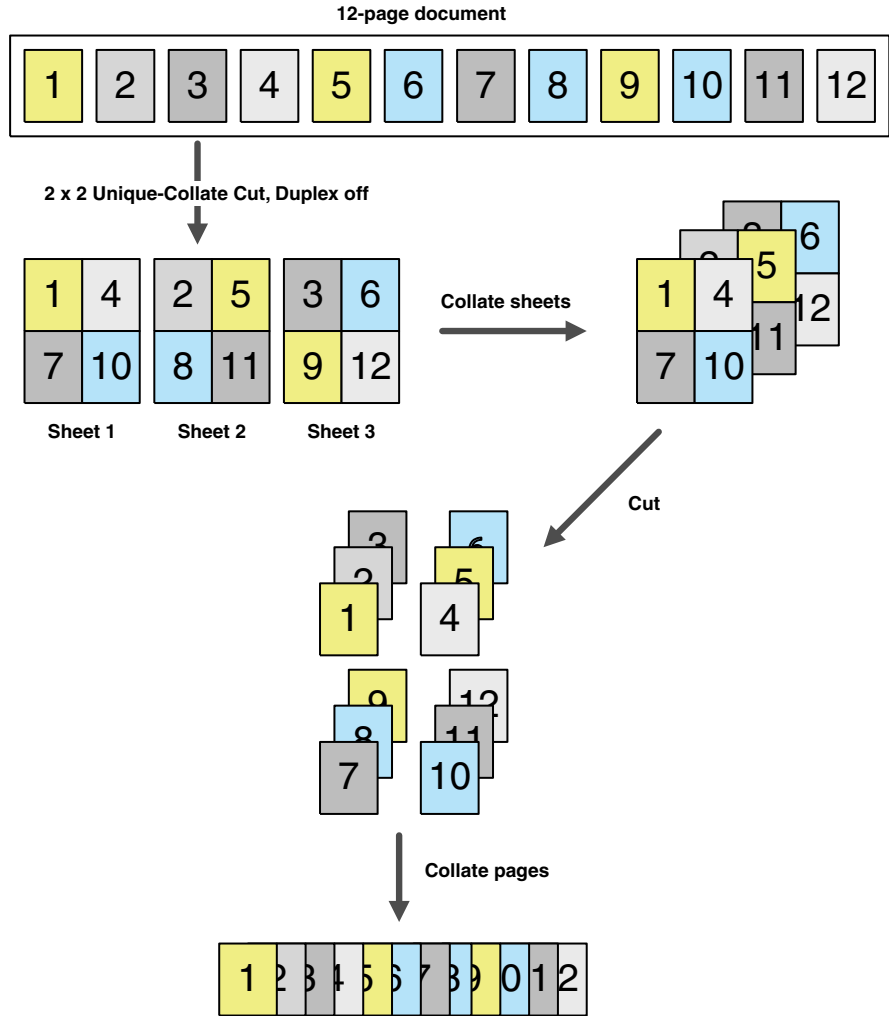



## Modifying the layout manually

Whether you apply a predefined layout or specify custom settings, you can manually modify a job's layout in the following ways:

- Reorder pages.
- Add, duplicate, and delete pages.
- Rotate pages.
- Set gutter sizes.

**Note:** Specify the following settings before making any manual changes to the layout: Orientation, Duplex, Rows, Columns, and Binding. If you specify any of these settings after making manual changes, you are prompted with a message indicating that the manual changes will be cancelled.

### Reordering pages in Layout mode

When you impose a job, its pages are automatically arranged in a particular order, according to the layout you select. Each page number in Layout mode represents the page from the source document that DocBuilder Pro images in a designated position on the finished sheet. However, to reorder individual pages manually, arrange them in the main window. To assign a different page to a particular location in the layout, use the following procedure.

---

#### To reorder pages

**1. Verify that Layout mode is selected.**

**2. Select the location's current page number.**

You can also press Tab to move to the next slot in the layout, or press Shift + Tab to move to the previous slot in the layout.

**3. Type the new page value and press Enter.**

You can add a blank cover page by typing 0 (zero) for any page number. Page 0 will be printed as a blank page.

**Note:** When you use this procedure to reorder pages, the page number you enter overwrites the original. For example, if you typed Page 3 in place of Page 5, you will now have two of Page 3 and no Page 5. Also, you cannot enter a page number that does not already exist in your job. For example, if your job has 10 pages, you cannot type 12.

## Adding, duplicating, and deleting sheets

You can add, duplicate, or delete sheets by right-clicking any sheet in either Preview or Layout mode.

---

### To add or duplicate sheets

1. **Right-click a sheet in Preview or Layout mode, and then choose Add Sheet(s) or Duplicate Sheet from the menu that appears.**

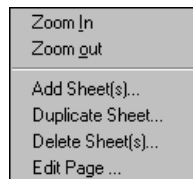

2. **If you are adding sheets, specify the number of sheets to add.**

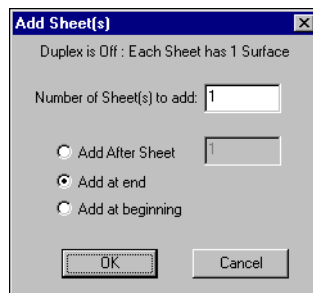

3. **If you are duplicating sheets, specify the number of the sheet to duplicate.**

# 6

## 6-147 Modifying the layout manually

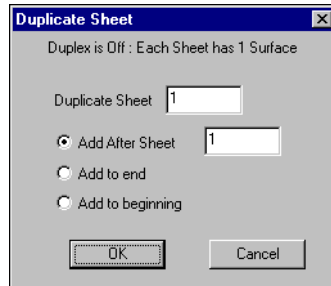

4. **Select the location to insert added or duplicated sheets, and click OK.**

---

### To delete sheets

1. **Right-click a sheet in Preview or Layout mode and choose Delete Sheet(s) from the menu that appears.**

The Delete Sheet(s) dialog box appears.

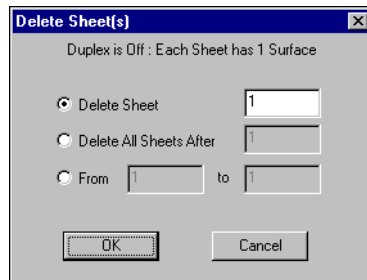

2. **To delete a single sheet, select Delete Sheet and specify the number of the sheet you want to delete.**

**To delete a range of sheets, select Delete All Sheets After and specify the starting number of the sheet range to delete, or select From and enter values for the start and end numbers of the sheets to delete.**

A single sheet or range of sheets is deleted, depending on what you have specified.

3. **Click OK.**

## Editing page content

You can use the Enfocus PitStop software (installation instructions included with the DocBuilder Pro option) to edit the content of pages in a job. PitStop functions as a plug-in that adds enhanced PDF editing tools to Adobe Acrobat.

**Note:** For best results, make edits to page content *before* performing sheet-level operations such as adding, duplicating, or deleting sheets. Editing page content causes the cancellation of all previous sheet-level operations.

---

### To use PitStop with DocBuilder Pro

1. Right-click a sheet in Preview or Layout mode and choose **Edit Page** from the menu that appears.
2. Or, display the full-screen preview for the spooled/held PostScript or PDF job in Command WorkStation (see [page 4-105](#)), and click the **Edit Page** icon.



**Edit Page icon**  
(in full-screen preview)

Adobe Acrobat starts and displays the document. The standard Acrobat tools are available for use, as well as the PitStop tools, which display with purple lines.

# 6

## 6-149 Modifying the layout manually

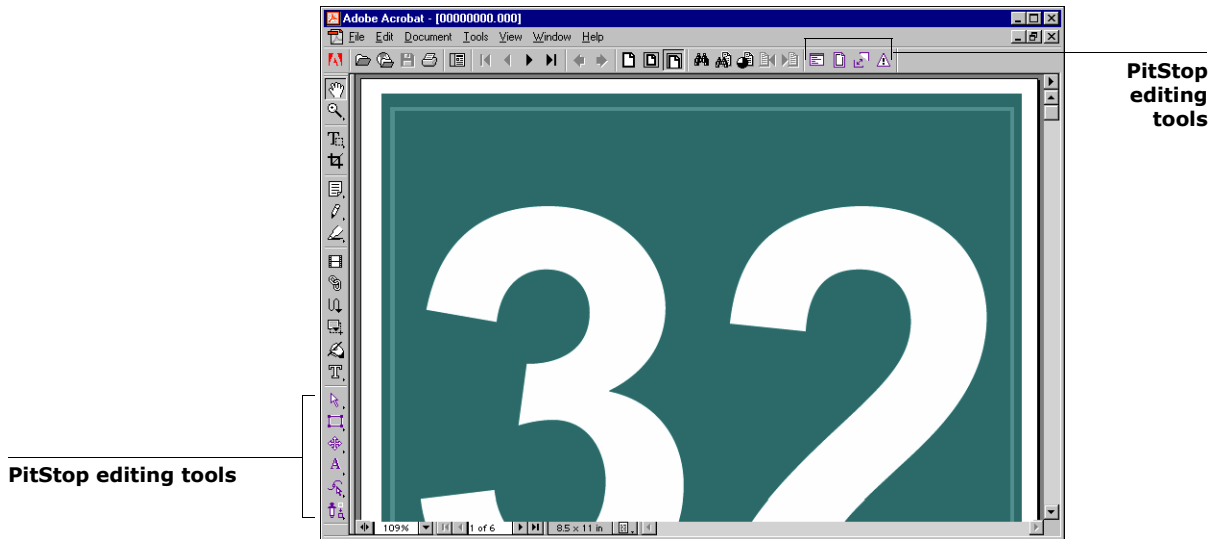

### 3. Use the PitStop editing tools to edit the document content.

For instructions on using PitStop, see your online PitStop documentation. To access this documentation, choose Help > Plug-In Help > Enfocus PitStop Professional from the Acrobat menu.

### 4. When you have finished editing, click Close in the Acrobat window.

You are prompted to save the changes.

### 5. Click Yes.

### 6. Click the Command WorkStation window to bring it to the foreground.

The edited file appears in the full-screen preview window.

## Rotating pages

To manually rotate individual pages or sets of pages in a job, display the job in Layout mode and click the Rotate icon in the upper-right corner of a page. Rotation is performed in 90° clockwise increments for Mixed Page mode, or in 180° increments for Fixed Page mode.

# 6

If you apply a 90° rotation to a page in Mixed Page mode and then switch to Fixed Page mode, the rotation will be cancelled.

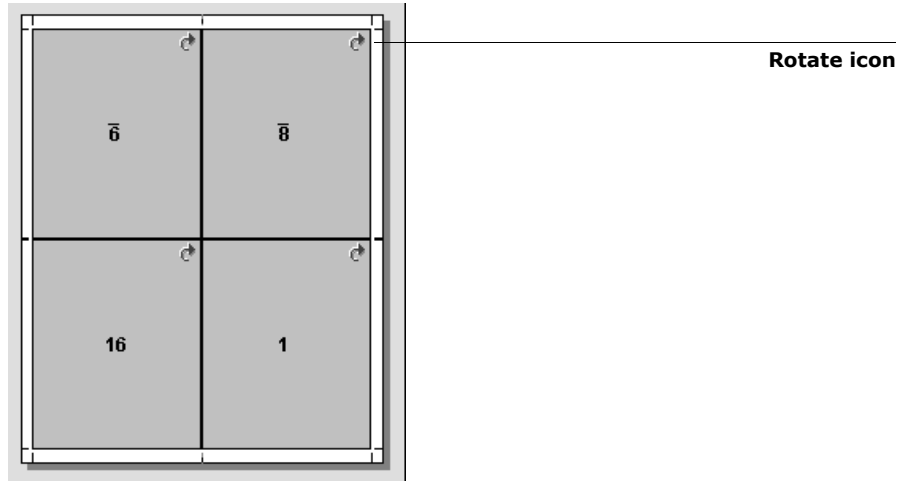

## To rotate pages

1. To rotate a single page, click the Rotate icon on that page.
2. To rotate all pages in the job, press the Shift and Ctrl keys and click the Rotate icon on any page.

6	8	7	01	11	6	5	12
16	1	2	5	14	3	4	13

Sheet 1, front side      Sheet 1, back side      Sheet 2, front side      Sheet 2, back side

3. To rotate all pages in a certain location on the front side of each duplex sheet, press the Shift key and click the Rotate icon on any page in that location on any sheet.

For example, in the preceding graphic, if you press the Shift key and click the Rotate icon on Page 8, Page 6 rotates as well, because both pages are in the same location on the front side of the sheet.

- 4. To rotate all pages in a certain location on the front and back sides of each duplex sheet, press the Ctrl key and click the Rotate icon on any page in that location on any sheet.**

For example, in the preceding graphic, if you press the Ctrl key and click the Rotate icon on Page 1, then Pages 2, 3, and 4 rotate as well, because they are in the same location on the front and back sides of the sheet.

### **Setting gutter sizes**

DocBuilder Pro defines the locations of gutters for you according to the layout and sheet size governing the imposition of the job. In Layout mode, you can specify the size of a gutter by entering a value in the gutter size field and pressing Enter. For example, perfect-bound jobs typically require larger gutters than saddle-stitched jobs, in order to provide room for grinding off the spines and gluing signatures together when the book is bound.

You can also specify a negative gutter value—for example, to join together two pages located in adjacent slots, or to offset the effect of an excess bleed value.

# 6

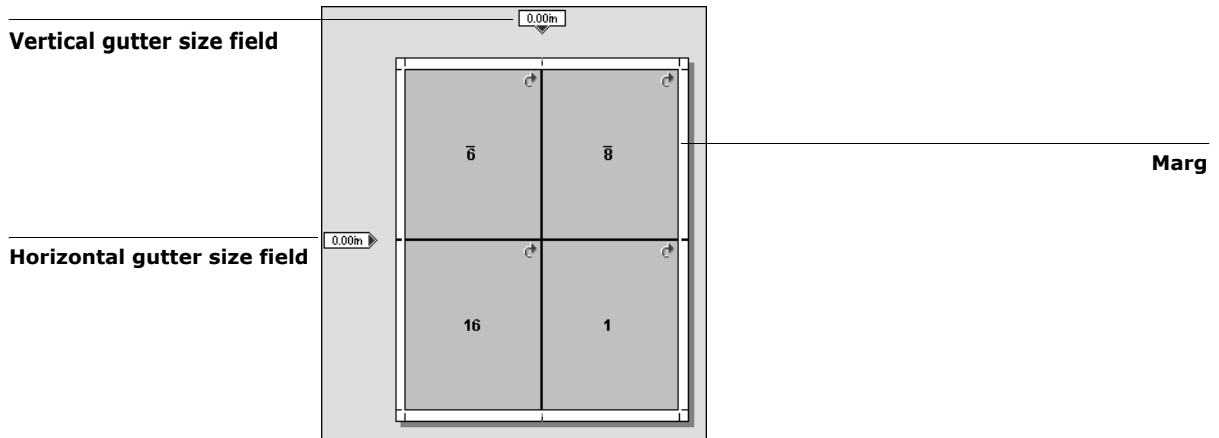

**Note:** The size and location of the margin (the area between the outside edge of a group of imposed pages and the edge of the sheet) is a function of the particular printer associated with the job. You cannot define custom margins.

### Managing templates

You can name and save the current combination of Sheet, Layout, Scale, and Finishing settings as a custom template. Choose Preferences from the File menu to set the folder or directory in which Command WorkStation saves templates (see ["Setting preferences"](#) on page 2-56).

You can save all imposition settings in custom templates, except the following:

- Sheet size setting
- Custom printer's marks properties
- The Pull into Page Edge setting and custom offset settings for printer's marks
- The Apply To setting in the Scale pane
- Settings made in Custom scale mode in the Scale pane



# 6

- Offsets settings in the Scale pane
- Fixed Page Mode or Mixed Page Mode settings
- Added, duplicated, or deleted sheets

---

## To save imposition settings as a template

1. Click the Save template icon.

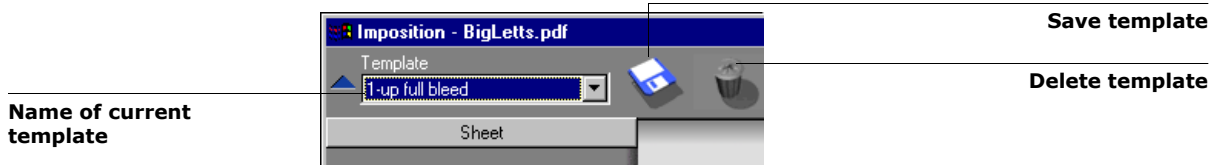

2. Type a name for the settings file in the Save Template As dialog box.

When saving a template, choose a descriptive name, such as "4-Up Nested Saddle." If you plan to use the same template for a particular document, name the template after the document type, for example, "Status Report."

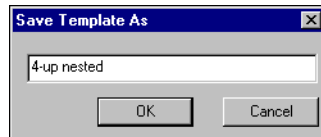

3. Click OK or press Enter.

Apply the template in the same manner as built-in templates, by choosing the template from the Template menu.

---

## To delete a saved template

1. Select the template you want to delete from the Template menu.
2. Click the Delete template icon.
3. Click OK or press Enter to delete the specified template.

## Tips for using the Imposition feature of DocBuilder Pro

This section provides information that will help you get the most out of the imposition features of DocBuilder Pro.

### Page-level operations

Consider the following when editing pages of a job:

- **Adding a binding offset**  
You can set gutters on each page independently to allow extra room for binding. For more information, see ["Setting gutter sizes"](#) on page 6-151.
- **Perform all page-level edits in the Preview window**  
For best results, perform all desired page editing operations in the Preview window *before* applying imposition settings to a file. Although you can perform page edits, such as adding, deleting, and duplicating pages, within the main Imposition window, these edits will be lost when you apply imposition settings that alter the page layout.

### Saving imposed jobs

When you save an imposed job, DocBuilder Pro does the following:

- **If new data has been added to the temporary PDF file, it is saved to the Fiery under the name you specify in the Save As dialog box.**  
The default name that appears in the Save As dialog box is that of the original spool file, with a new extension (.dbp). If you do not intend to overwrite the source file, you must enter a new name for the imposed job. The original PostScript or PDF remains intact, even after the converted file has been edited and saved in the Imposition window.
- **If imposition data has changed, the data is saved to the Fiery and associated with the new PDF.**

# 6

Maintaining associated imposition data separately from the job's PDF data allows DocBuilder Pro to impose in-RIP without modifying the PDF data, and allows you to reuse PDF data that has been modified in the imposition process.

---

### To save an imposed job

1. **Click the Close Window icon in the upper right corner of the DocBuilder Pro window.**
2. **Enter a name for the imposed job in the Save As dialog box.**

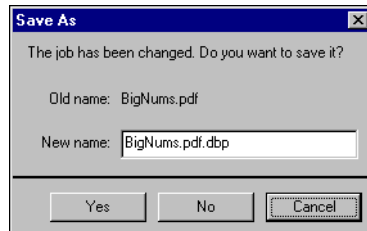

3. **Click Yes.**



## Chapter 7: Fiery WebSpooler and Fiery Spooler

Fiery WebSpooler and Fiery Spooler duplicate many of the functions and features of Command WorkStation. Each provides additional flexibility by allowing job tracking and management from multiple platforms over the Internet or an intranet.

- Fiery WebSpooler is accessed with an Internet browser from the Fiery home page.
- Fiery Spooler is installed from the User Software CD, and is available for Mac OS computers only. To use Fiery Spooler, users need only a network connection to the Fiery.

**Note:** The interface of Fiery Spooler for Mac OS computers is virtually identical to that of Fiery WebSpooler.

### Tracking and managing jobs with Fiery WebSpooler

Use Fiery WebSpooler to perform the following functions from your workstation:

- Override current job option settings.
- Delete jobs and cancel processing.
- Duplicate or rename jobs.
- RIP a job and hold the raster data.
- Hold jobs in the spooled area or the RIPped area.
- Remove raster data from RIPped files.
- Change the priority of jobs.
- Edit and merge raster data jobs.
- Display, print, export, or delete the Job Log



Most of these functions require an Administrator or Operator password. However, even without a password, you can log in to Fiery WebSpooler as Guest with view-only privileges.

**Note:** Most Fiery WebSpooler commands are identical to those of Command WorkStation. For more information on specific commands, see Chapters 2 and 3.

---

### To start Fiery Spooler on a Mac OS computer

**1. Double-click the Fiery Spooler icon.**

**2. Select the Fiery in the Chooser window.**

For information on setting up the connection to the server, see the [User Software Installation Guide Chapter 2](#).

**3. Click OK.**

**4. Log in to the Fiery.**

- To log in as Administrator, enter the Administrator password and click OK.
- To log in as Operator, enter the Operator password and click OK.
- To log in as Guest, click OK without entering a password.

The Fiery Spooler main window appears.

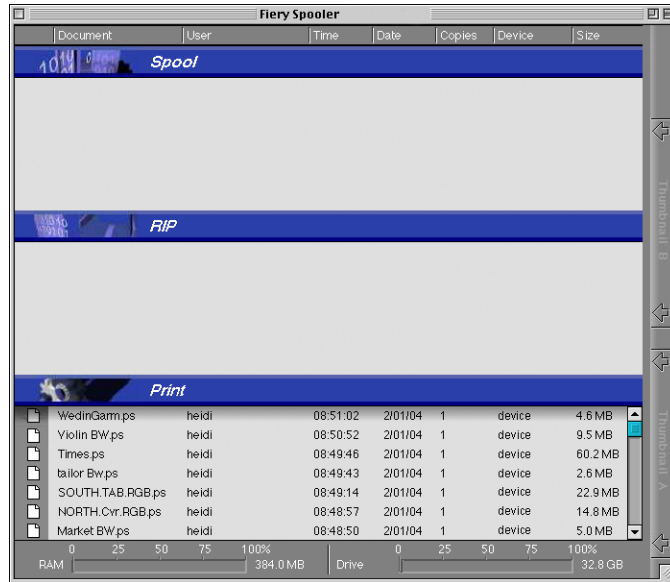

## To access the Fiery WebSpooler window

- 1. Start your Internet browser.**
- 2. Enter the IP address or DNS name of the Fiery.**  
Consult the operator or administrator for this information.  
The Fiery WebTools home page appears.
- 3. To log in as Administrator, enter the Administrator password and click OK.**  
**To log in as Operator, enter the Operator password and click OK.**  
**To log in as Guest, click OK, without entering a password.**

If the administrator has not set an Administrator or Operator password in Setup, you are not prompted for a password.

The Fiery WebSpooler window appears in a new browser window.

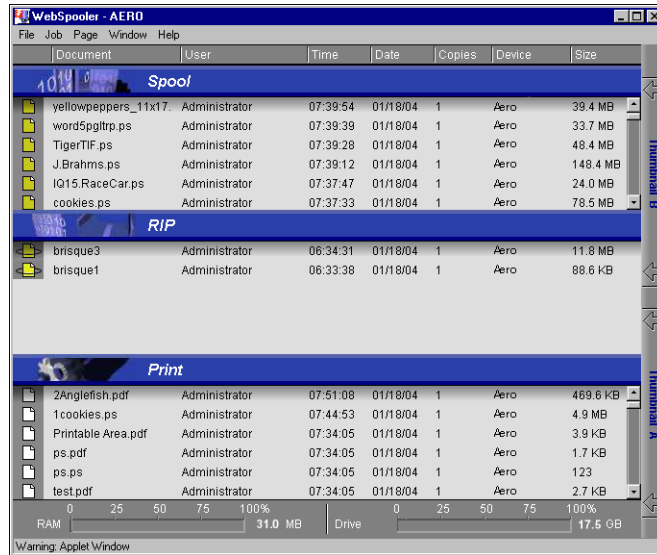

## About the Fiery WebSpooler window

Similar to Command WorkStation, Fiery WebSpooler allows you to view Fiery and printer functions, and act as an interface from which you can control those functions.

The Fiery WebSpooler window is divided into three areas by Spool, RIP, and Print status bars. When the Fiery receives print jobs, the Fiery WebSpooler window becomes a dynamic display, filled with the names of jobs and their characteristics.

The Spool, RIP, and Print areas of the Fiery WebSpooler window represent the stages of printing a job. Jobs come in at the top level (Spool) and drop down to the Print level, unless they are held along the way.

The job icons displayed in the Fiery WebSpooler window are explained on [page 7-164](#).



The RAM status bar indicates the amount of memory in use. The Drive status bar indicates the amount of hard disk drive space in use.

**Note:** In the Fiery WebSpooler window, the background color for the yellow and white printer icons is the same.

**Spooled jobs**—Jobs listed in the area below the Spool status bar are PostScript or PCL files stored on the Fiery hard disk drive. These jobs were sent to either the Print queue (white icons) or the Hold queue (yellow icons).

**RIPped jobs**—Jobs listed in the area below the RIP status bar are ready to print. They have been rasterized (RIPped, or processed for printing) and are waiting, in order, for access to the printer. Rasterized jobs can also be held; held jobs are indicated by a yellow icon.

**Printed jobs**—Jobs listed in the area below the Print status bar have already been printed. Printed jobs can be stored on the Fiery hard disk drive. The number of jobs you can store (from 1 to 99) is defined in Setup.

If you are logged in as Administrator or Operator, you can interact with a job wherever it appears in the window by selecting it and choosing a command from the Job menu, or by double-clicking the job and setting override options. For more information, see [“Manipulating job options and job flow”](#) on page 7-161.

**Errors**—Jobs with an error are shown in red. To display the error, double-click the job. Note that you cannot check the job properties or hold a job with an error.

**Note:** If your job does not appear anywhere in the Fiery WebSpooler window, it may have already printed; if so, it appears in the Job Log. To view the Job Log, choose Show Job Log from the Window menu. For more information on the Job Log, see [page 7-176](#).



If the job does not appear in the Job Log, it may have been moved to the Archive window by the operator. The Archive window cannot be viewed with Fiery WebSpooler; you must contact the operator or go to the Command WorkStation screen to check this.

### Manipulating job options and job flow

Using the commands in the Job menu, you can alter the destinations, priorities, and characteristics of jobs that appear in the Fiery WebSpooler window.

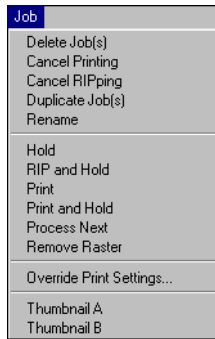

To understand the effect each of these commands has on a job, you must understand the way the Fiery handles PostScript, PCL, and raster data, and how jobs are activated or held in the various stages of processing. For this background information, see [Chapter 1](#) before manipulating jobs with Fiery WebSpooler.

Choose this command from the Job menu	To do this	Raster data is
Delete Job(s)	Delete the job(s) from the list.	Deleted
Cancel Printing	Cancel the currently printing job.	Deleted
Cancel RIPping	Cancel the currently processing job.	Deleted



<b>Choose this command from the Job menu</b>	<b>To do this</b>	<b>Raster data is</b>
Duplicate Job(s)	Duplicate one or more selected PostScript or PCL data jobs in the Spool or Print areas (creates a reference to the original job, with the same name).	n/a (Duplicate is not available for raster jobs.)
Rename	Rename the job (PostScript or PCL file with or without raster).	Unaffected, but associated with the new name
Hold	Hold the job in the current place (except for a printed job, which is moved to the Spool or RIP area).	Held in RIP area indefinitely, if included with job
RIP and Hold	RIP the job and hold it in the RIP area.	Held in RIP area indefinitely
Print	Print the job in its turn (RIP the job first if it does not have raster data). Keep the printed job in the Print area until the job limit is reached.	Temporarily held on the server until the job has completed printing
Print and Hold (like the PPD option Save Fast Reprint)	Print the job in its turn (RIP the job first if it does not have raster data). After printing, hold the PostScript or PCL data and the raster in the RIP area.	Held in the RIP area indefinitely (saved to disk)
Process Next	Give top priority to this job. Print the job (or RIP and print) as soon as the processor and printer are free, before other waiting jobs.	Held in RAM after printing (can be selected in the Print area while it remains there), or held in RIP area (saved to disk) if destination was RIP and Hold
Remove Raster	Remove the raster from a job that has raster data; leave the PostScript or PCL job in place.	Deleted



<b>Choose this command from the Job menu</b>	<b>To do this</b>	<b>Raster data is</b>
Override Print Settings	Change the print options for the job (see <a href="#">page 7-163</a> ).	Deleted and regenerated, if the newly selected options require reRIPping, or reprinted with the new settings, if none require reRIPping
Thumbnail A	Open the selected held raster data job in the Thumbnail A window, where you can view a full-screen preview of the job, edit the job, or merge it with raster data from other jobs.	Changed if job is edited, unaffected if job is only viewed
Thumbnail B	Open the selected raster data job (not necessarily a held job) in the Thumbnail B window for viewing or for merging into a job in the Thumbnail A window.	Unchanged

### **Overriding job option settings**

To change the job options of a job, select the job and choose Override Print Settings from the Job menu. Click the tabs in the Override Print Settings dialog box to see all the job options.

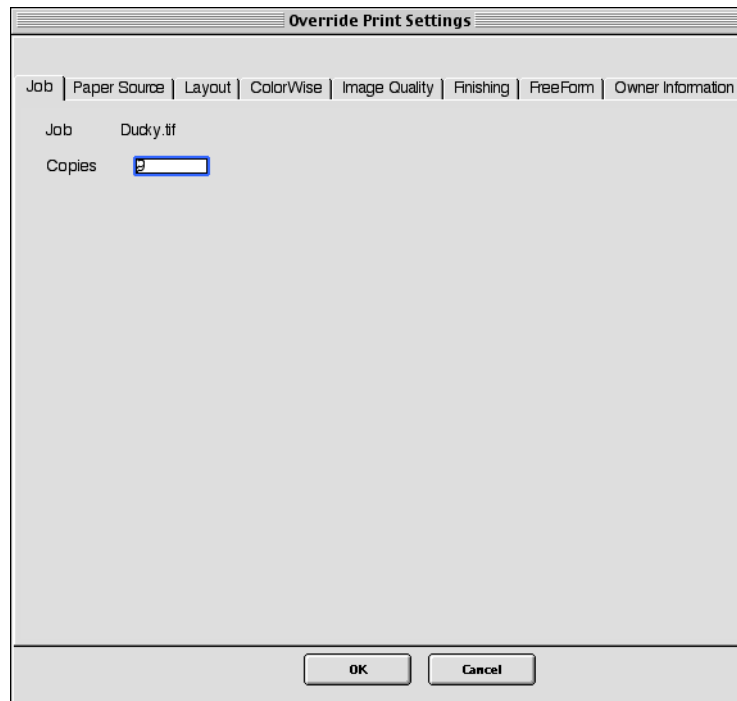

**Note:** If an icon appears to the left of an option's setting, it indicates that changing the option's setting requires the job to be reRIPped. When you override these types of options, the job is automatically reRIPped for printing.



The options set here are the same ones you set from the Print dialog box when you print from an application. For information about setting and overriding these print options, see Appendix A of the [Printing Guide](#).

## Job icons

Three types of icons are used for both active jobs and jobs on







hold.

Icon	Active jobs (white icons and rows)	Jobs on hold (yellow icons and rows)
  Printer icons	PostScript, PCL, or raster data headed for printing (top) or after printing (bottom)	PostScript or PCL data headed for Print and Hold or job on Hold after printing (Hold)
 Raster icon	PostScript, PCL, and raster data after printing, ready for	PostScript or PCL data already rasterized and held

### Spool area

The job icons in the Spool area are as follows:

Spool area icon	What it indicates	How long you see the job
<b>1</b> 	PostScript or PCL data from a user on the network; no destination is defined	Until a destination is chosen
<b>2</b> 	PostScript or PCL data headed for Print	Until the RIP is free
<b>3</b> 	PostScript or PCL data headed for RIP and Hold	
<b>4</b> 	PostScript or PCL data headed for Print and Hold	

The Spool area is both the receiving area for jobs from users on the network (Hold queue) and the waiting area for jobs that will be RIPped.



**Hold queue jobs**—When printing requires an operator (because the Print queue and Direct connection are disabled), the operator must assign a destination to all jobs received from users on the network (Icon 1). Once assigned, jobs move down the Spool queue for processing (Icons 2, 3, and 4). All jobs printed to the Hold queue require routing by an operator.

**Print queue jobs**—When printing does not require an operator, network jobs sent to the Print queue appear in the Spool area, where they are displayed with a white printer icon (Icon 2). When jobs reach the head of the queue, they are RIPped and printed without operator intervention.

**Direct Connection**—Jobs printed to the Direct connection are not displayed in the job lists. They are displayed briefly in the status bars (where they cannot be selected) and are included in the Job Log.

## RIP area

The job icons in the RIP area are as follows:

RIP area icon	What it indicates	How long you see the job
1 	Raster data, no destination defined; may have been printed before and held	Until it is deleted, moved to the Archive window, or stripped of its raster data and sent to the Spool area
2 	Raster data headed for Print in its turn; no hold defined	Until printer is free to print the job

After a job is rasterized, it goes into the RIP area. The RIP area holds only jobs with raster data. Jobs in the RIP area are either waiting for the printer to be free (Print queue jobs, Icon 2), or they are being held (Icon 1). Held jobs in the RIP area have

already been rasterized (RIP and Hold), or they have been printed and their raster data has been routed back to the RIP area (Print and Hold).

**Note:** Raster jobs in the RIP area that are waiting to print (Icon 2) cannot be manipulated by job commands.

## Print area

The job icon in the Print area is as follows:

Print area icon	What it indicates	How long you see the job
1 	PostScript or PCL data only—raster data has been deleted	Until the job limit is reached

The Print area, also referred to as the Printed queue, contains jobs that have already been printed. These jobs were assigned the Print destination (white printer icon in the Spool or RIP areas) without any Hold instructions; therefore, they all have white icons.

**Note:** A job row that appears in light red indicates that an error occurred while printing the job. To see the error, double-click anywhere in the row.

While it is printing, a job consists of PostScript or PCL and raster data. The raster data in RAM is not cleared until memory is needed to rasterize the next job. As long as the raster data is intact, the job can be reprinted from the Printed queue. Printed jobs are represented by a white PostScript icon (Icon 1). If the job was printed from a held raster job (in the RIP area), the raster data in the RIP area remains and can be used to reprint the job after the raster data has been cleared from the Printed queue.

## Previewing, editing, and merging jobs

Fiery WebSpooler includes two thumbnail windows that allow you to preview and edit raster data. You can use the thumbnail



windows in the following ways:

- In Thumbnail A, you can view the currently printing job as it is RIPping, or any raster data job.
- From Thumbnail A, you can open a full-screen preview of a raster file.
- Using Thumbnail A and Thumbnail B together, you can merge raster data from more than one file, even if the files were printed from different applications on different computer platforms.

The job merge features eliminates the limitations of certain software applications. You can merge raster pages of documents of different types, and from different computer operating systems. You can merge color pages from graphics programs with text pages from a word processor.

### **Previewing raster jobs**

You can use Thumbnail A to preview pages of the currently RIPping job. You can also use Thumbnail A and Thumbnail B to preview any held raster data job in the RIP area.

The thumbnail windows also allow you to open a thumbnail view of any held raster data job in the RIP area and perform electronic collation or document merging. For more information about this feature, see [page 7-172](#).

### **Previewing the currently rasterizing job**

To see the progress of jobs as they are RIPped, leave Thumbnail A open in RIP Preview mode.

---

## **To view thumbnails of the currently RIPping file**

- 1. Click the Thumbnail A tab at the right of the Fiery WebSpooler window.**



2. **Click the RIP preview icon at the left side of the Thumbnail A window.**

In this mode, Thumbnail A displays each page of the currently processing job after it has been RIPped.

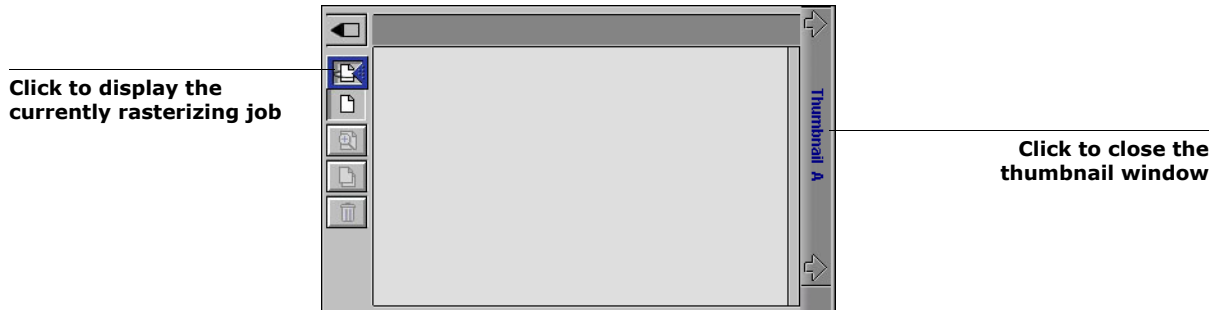

3. **Choose a PostScript file in the Spool or Print area and select RIP and Hold, Print, or Print and Hold.**  
As pages are RIPped, they are displayed in Thumbnail A.
4. **When you have finished viewing, click the Thumbnail A tab to close the thumbnail window.**

---

### To view thumbnails of any raster data file

1. Select any raster data job in the RIP area.
2. Choose **Thumbnail A** or **Thumbnail B** from the **Job** menu.

**Note:** Wait until all pages have been displayed before opening another raster file with Thumbnail A. If the job contains many pages, it may take some time for the entire job to be displayed.

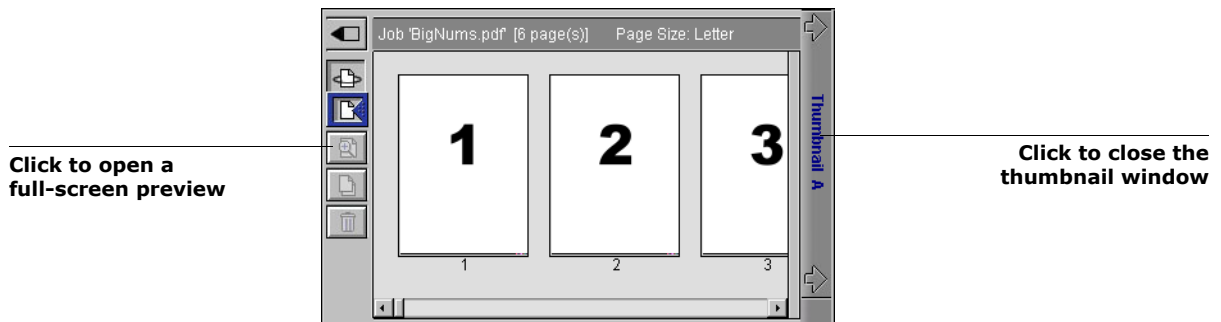

3. When you have finished viewing, click the **Thumbnail A** or **Thumbnail B** tab to close the thumbnail window.

### Displaying full-screen previews

You can open a full-screen preview of any page in the Thumbnail A window.

The full-screen preview is a view-only display, and it takes time to retrieve the data.

---

### To open a full-screen preview

1. In **Thumbnail A**, select a page and click the **Full Preview** icon at the left of the window.

You can also display full-screen previews by double-clicking the page in Thumbnail A.

**Note:** If you have edited a job using the thumbnail windows, you must save the edited file before you can view full-screen previews of all its pages.

2. To close the full-screen preview, click the “X” button above the preview.

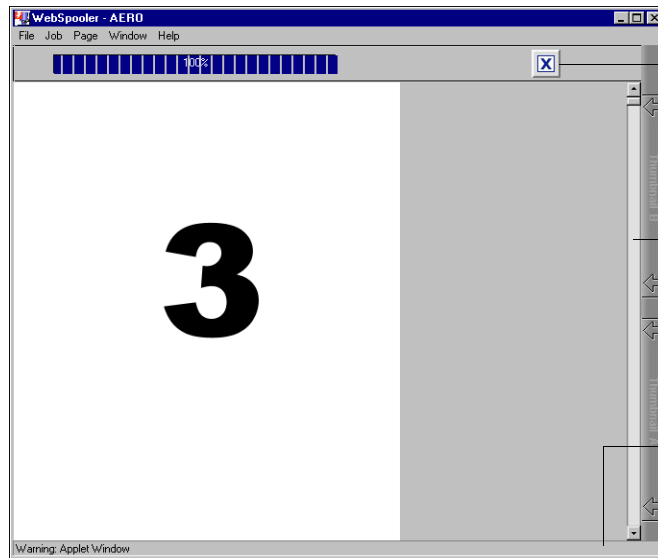

Click to close the full-screen preview

If scroll bar appears, click arrows or empty spaces, or move bar to scroll up or down

If scroll bar appears, click arrows or empty spaces, or move bar to scroll left or right

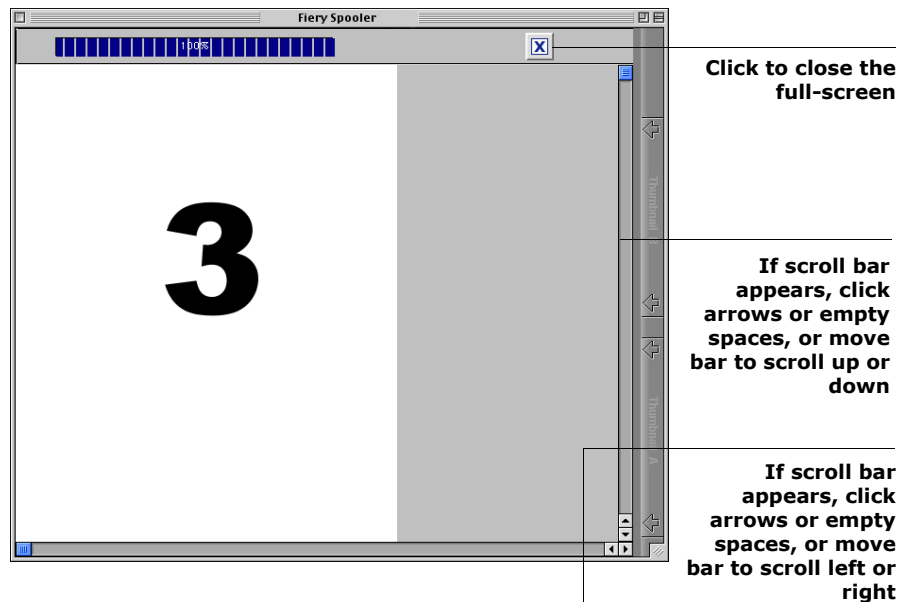

## Editing and merging raster files

The ability to work with raster files gives you new opportunities to combine documents from different sources into a single file. For example, you can combine covers and chapter head pages created in a page layout application with text pages created in a word processing application, or customize a slide presentation by inserting slides from a different presentation graphics application.

You can display two raster files at once: a source file and a target file. The target file appears in Thumbnail A, and the source file appears in Thumbnail B.

**Note:** You cannot create a new PostScript file in this process; you must print the merged file, which has references to the original PostScript files. Before editing or merging raster files with the thumbnail windows, make sure the source files were RIPPed using the print option settings you want for the final output.

## To view and edit raster data jobs

1. Select a raster data job in the RIP area, and choose **Thumbnail A** from the **Job** menu.
2. Open the **Page** menu to see the commands available for pages in **Thumbnail A**.

You can also access most of these commands by clicking the icons along the left side of **Thumbnail A**.

You can use the slider bar at the bottom of the window to scroll through pages in the job.

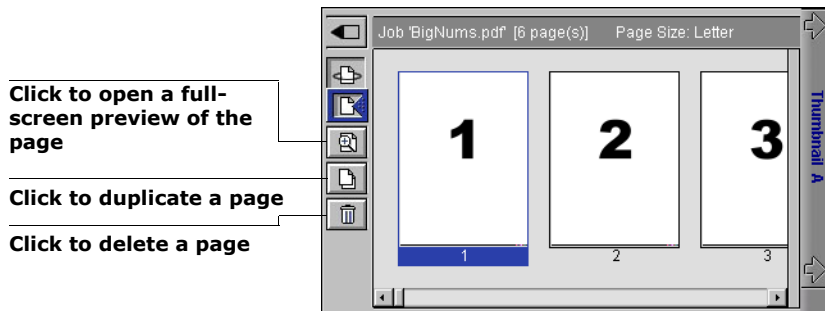

**Delete**—Deletes the currently selected pages.

**Duplicate**—Duplicates the currently selected pages.

**Preview**—Opens a full-screen preview of the currently selected page (see "[Displaying full-screen previews](#)" on page 7-170).

**Undo**—Reverses the action of recently performed page edits.

3. To move pages within **Thumbnail A**, click to select the pages and hold down the mouse button as you drag the selected pages to the new location.

Shift-click to select multiple, sequential pages; Ctrl-click to select multiple, non-sequential pages.

To move pages to a new position, drag until a blue highlight appears in the desired position, and then release the mouse button.



If you move the pages on top of existing pages, the pages will be overwritten.

**4. When you are finished editing, click the Thumbnail A tab.**

If you have edited the job, you are prompted to save the job.

**5. Enter a new name and click OK.**

The new file is now located in the RIP area, ready to print. If you saved the edited file with a new name, the original source file remains held in the RIP area.

---

### To merge two raster data jobs

**1. In Thumbnail A, display the job you want to edit.**

The file must be a held raster data job in the RIP area.

**2. In Thumbnail B, display another held raster job from the RIP area.**

The Thumbnail B tab opens a second thumbnail view, which cannot be edited but can be used as a source for pages added to the document in Thumbnail A.

**Note:** To merge documents, the page sizes of the source document and the target document must be the same. Before editing or merging raster files with the thumbnail windows, make sure the source files were RIPped using the print option settings for the final output.

**3. In Thumbnail B, click to select the pages and hold down the mouse button as you drag the selected pages to the new location in Thumbnail A.**

Shift-click to select multiple, sequential pages; Ctrl-click to select multiple, non-sequential pages.

To scroll through the pages in Thumbnail A and Thumbnail B, you can drag the slider bar at the bottom of the screen, click the empty area to the left or right of the slider bar, or click the arrows.

To replace pages, drag Thumbnail B pages on top of pages in Thumbnail A. To add pages, drag the pages to a new position in Thumbnail A; a blue highlight appears in the new position when the pages are ready to be added.

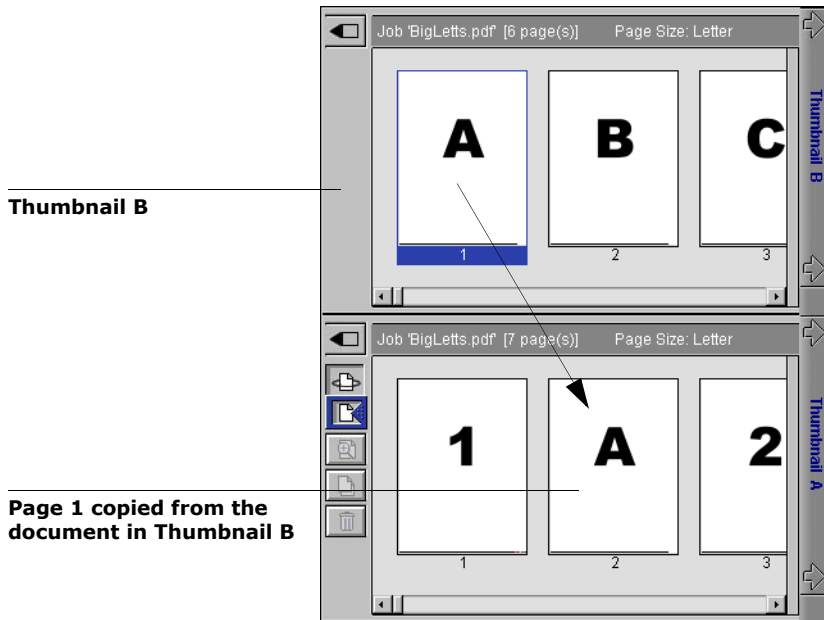

Multiple levels of undo are available; use Undo to undo all the way back to your first edit. There is no Redo function.

**Note:** Make sure to save the merged job before deleting any of the jobs you used to create the merged job.

Thumbnail B pages moved into Thumbnail A adopt some specific attributes of the Thumbnail A job, such as the document and user name.

4. To close a thumbnail window, click the same tab you used to open it (the Thumbnail A or Thumbnail B tab).
5. If you have edited Thumbnail A, you are prompted to save the job.
6. Enter a new name and click OK.

The new raster file is now in the RIP area, ready to print, together with the original source and target files.

**Note:** When multiple users are connected to the Fiery via Command WorkStation, Command WorkStation LE, Fiery WebSpooler, or Fiery Spooler, and one user makes changes to a Thumbnail A job, not all users may see the results of those changes. If you are unable to view changes in a job, or if selecting a thumbnail window results in a message indicating zero pages, close and restart Command WorkStation, Command WorkStation LE, Fiery WebSpooler, or Fiery Spooler.

## Using the Job Log

From Fiery WebSpooler, you can view and print a log of all jobs printed by the Fiery, including jobs downloaded with Fiery Downloader.

**Note:** If you logged in as Administrator, you can delete the Job Log from Fiery WebSpooler (see [page 7-178](#)). The Job Log is not available if you logged in as Guest.

---

### To display, update, print, delete, and save/export the Job Log

1. Choose **Show Job Log** from the **Fiery WebSpooler Window** menu.
2. Select **All** or specify a date range.

3. Click **OK**.

The Job Log appears in a new browser window.

**Note:** The Delete button appears only if you logged in as Administrator.

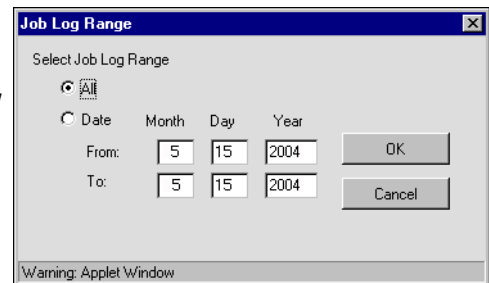





## 7-177 Previewing, editing, and merging jobs

Status	Document	User	Date	Start Time	End Time	Process Time	Size
Cancel	10.ps	amandah	01/27/04	17:04:21	17:10:35	00:00:01	821.0 KB
OK	Configuration	Operator	01/28/04	14:04:49	14:05:33	00:00:01	9.9 KB
OK	BigNums.pdf	kevinc	01/28/04	22:13:20	22:13:21	00:00:01	8.7 KB
OK	BigLetts.pdf	kevinc	01/01/04	01:51:43	01:51:44	00:00:01	6.7 KB

Warning: Applet Window

Update  
Print  
Delete  
Export

Status	Document	User	Date	Start Time	End Time	Process Time	Size
OK	Startup	Operator	06/11/03	17:56:32	11:03:12	17:06:40	289 KB
OK	Configuration	Operator	06/13/03	12:22:22	12:22:41	00:00:19	12.6 KB
OK	Microsoft Word - p2.doc	jzhao	06/13/03	12:40:13	12:40:22	00:00:02	394 KB
OK	Configuration	Operator	06/13/03	14:12:30	14:12:35	00:00:05	12.6 KB
OK	Printer Test Page	ying	06/13/03	14:14:20	14:14:24	00:00:01	60.8 KB

Update  
Print  
Delete  
Export



The Job Log displays each job and information about the job, including status, document name, user name, date, start time, end time, process time, page description language, file size, device, paper size, media, number of originals, total number of pages, and Notes.

The Status column provides the following information about jobs:

OK	The job printed normally.
ERROR	An error occurred during processing or printing.
CANCEL	The job was canceled before printing was completed.

- 4. To update the Job Log, click the Update button.**
- 5. To print the Job Log, choose Print Job Log from the File menu or click the Print button.**

The information displayed in the Job Log window prints to the current Fiery. When you print the Job Log, totals are printed for all appropriate columns.

- 6. If you logged in as Administrator, you can choose Delete Job Log from the File menu or click the Delete button to clear the Job Log.**
- 7. To save the Job Log, choose Export Job Log from the File menu or click the Export button.**
- 8. In the File name area, enter a name for the Job Log.**
- 9. Browse to the location where you want to save the file, and click Save.**

The Job Log is saved as a text file, and the Job Log window reappears.

You can view the information in any application that can read a text file. Items are separated by tabs.

To return to the job list, choose Show Job List from the Window menu.



## Fiery Spooler for Mac OS computers

For Mac OS, the Fiery Spooler interface is almost identical to that of Fiery WebSpooler (see ["Connecting to a different Fiery from Fiery Spooler"](#) on page 7-180).

### Starting Fiery Spooler

Use the following procedure to start Fiery Spooler.

---

#### To start Fiery Spooler on a Mac OS computer

**1. Double-click the Fiery Spooler icon.**

**2. Select the Fiery in the Chooser window.**

For information on setting up the connection to the server, see the [User Software Installation Guide Chapter 2](#).

**3. Click OK.**

**4. Log in to the Fiery.**

- To log in as Administrator, enter the Administrator password and click OK.
- To log in as Operator, enter the Operator password and click OK.
- To log in as Guest, click OK without entering a password.

The Fiery Spooler main window appears.

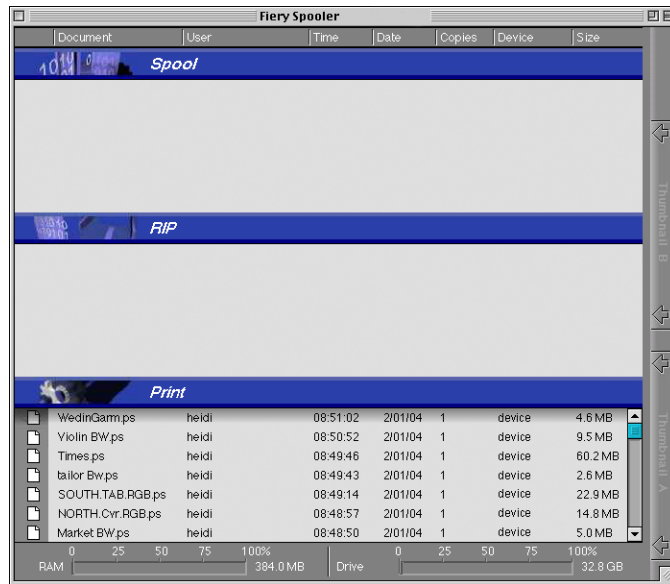

For details on managing jobs in Fiery Spooler and Fiery WebSpooler, see ["Manipulating job options and job flow"](#) on page 7-161. For details on the job icons that appear in Fiery Spooler, see ["Job icons"](#) on page 7-164.

The RAM status bar indicates the amount of memory in use. The Drive status bar indicates the amount of hard disk space in use.

## Connecting to a different Fiery from Fiery Spooler

Although the Fiery Spooler for Mac OS and Fiery WebSpooler interfaces are nearly identical, the method for establishing and changing a connection to the Fiery differs between the two. With Fiery Spooler, you can connect to a different Fiery using the following procedure.

---

### To connect to a different Fiery

1. Choose **Open Fiery** from the **File** menu.



**2. Select the Fiery in the Chooser window.**

For information on setting up the connection to the server, see the [User Software Installation Guide Chapter 2](#).

**3. Click OK.**

The Fiery Spooler main window appears.

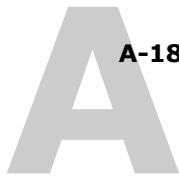

## **Appendix A: Basics of Imposition**

This chapter introduces the basic concepts of imposition and can be used as an introductory tutorial for imposing a document that will be printed as a book or booklet. For more detailed information on the Imposition main window and its components, see Chapters [5](#) and [6](#).

### **Printing books with the Imposition feature of DocBuilder Pro**

This section describes the process of transforming an application-specific file into a bound book; along the way, concepts and terminology are introduced to help you take advantage of all the features of DocBuilder Pro.

Printers and copiers that image documents on standard Letter- or Legal-sized paper at high speeds are common in office environments. Although the image quality and output efficiency of such devices is adequate for correspondence and office memos, they cannot image jobs with complex document layouts, or those that require higher resolution or a large number of copies.

Until recently, the only way around these limitations was to use traditional printing systems to impose your document—that is, to arrange its pages in the correct order and orientation for printing and a variety of binding styles. You might have used a service bureau to access high-volume, high-resolution color printers. However, DocBuilder Pro, teamed with your Fiery, now makes it cost-effective to produce short-run, fully-imposed (also called “ganged-up”) documents.

#### **Basics of imposition layout**

Commercial offset printers and web presses use wide rolls of paper and large printing plates capable of imaging numerous pages on a single sheet. For example, it is common for such printers to image up to 32 full-size pages on a single press sheet,

a process inherently faster than printing a single page at a time. DocBuilder Pro allows you to image multiple pages on a single sheet, but output directly on your Fiery, rather than traditional printing presses. In this manual, the paper on which a job is imaged is referred to as the sheet.

The printed sheet is folded into something resembling a booklet with connected pages. The folded sheet, called a signature, is then trimmed to the finished size.

For pages to appear in normal reading order and position in the final booklet, their ordering and positioning on the sheet must differ from the normal book-reading order. You can demonstrate this for yourself using an ordinary sheet of paper.

---

### To model an eight-page booklet

#### 1. Fold the paper in half horizontally.

Fold the top edge of the sheet down to meet the bottom edge.

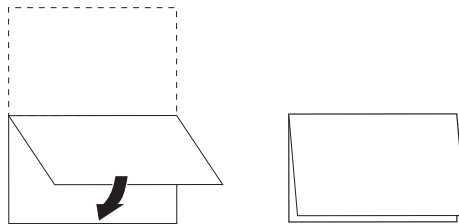

#### 2. Fold the paper again vertically.

Fold the left edge of the sheet over to the right edge. Now you have a miniature version of a signature.

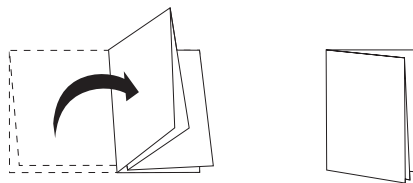

- 3. Position the signature with the vertically folded edge to the left and the horizontally folded edges across the top.**

The paper should now resemble a small eight-page booklet (with the tops of pages joined at the fold).

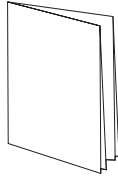

- 4. Page through the booklet as if you were reading it, and number each page sequentially.**

Number the front and back of each page—in general, books have content on both sides of each page. The front cover of the booklet should be page 1 and the back cover of the booklet should be page 8. You can also underline each number to highlight the page orientation.

**Note:** Printing on both sides of the sheet is called duplex printing; printing on only one side of the sheet is called simplex printing. Not all printers support duplex printing; and of those that do, variations in implementation exist. DocBuilder Pro supports duplex printing that corresponds to the print options of your Fiery.

When you unfold the signature, the page numbering should look something like the following illustration.

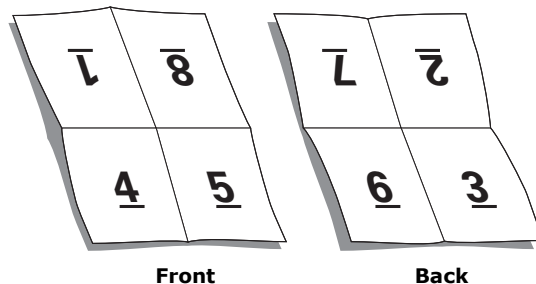



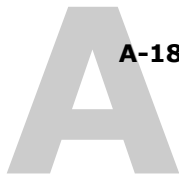

Notice that:

- The folds subdivide the sheet into areas representing pages in the final booklet.
- Page numbers do not appear in book-reading order.
- Some page numbers are upside down.

Some pages must be printed upside down on the sheet in order for them to appear right-side up in the final booklet, and pages must also be printed out of numerical sequence on the sheet in order for them to appear in numerical sequence in the final booklet.

This process of folding paper and numbering pages to approximate the finished piece is called making a folding model, and it is a common first step in planning a print job. The folding model provides valuable information about page placement, which you can use to create a plan, or sketch, of how pages are placed on the sheet. This plan is called a layout.

DocBuilder Pro frees you from the tedious and error-prone process of creating accurate physical models of the imposed book in order to lay out pages. With DocBuilder Pro, you simply open the source file to be imposed and specify how many rows and columns of pages to image on a sheet. DocBuilder Pro simplifies this process even further by providing predefined layouts for common impositions such as booklets and brochures. You can also save your own custom layouts for easy reuse.

### **Printer's marks**

In addition to specifying the placement of pages on a sheet, the layout also specifies how the finished sheet will be cut and folded. For example, the layout specifies whether the large finished sheet is folded and cut to create a booklet, or simply folded (and not cut) like a map.

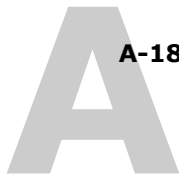

A DocBuilder Pro layout designates the location of folds, cuts, and other elements by means of markings called printer's marks, which appear on the printed sheet outside the main content area of the job.

- The job label comprises descriptive text such as the name of the job, a sheet identifier, and the date and time the sheet was printed.
- The location of a fold is defined by a dotted line called a fold mark; similarly, the location of a cut is defined by a solid line called a trim mark.
- Specialized marks also define the size and locations of margins (space surrounding the page's content area), gutters (space between pages), and bleeds (extensions of content beyond a trim mark; used to ensure that the printed area extends to the very edge of a trimmed page).

# A

DocBuilder Pro makes it easy to set up gutters and specify a set of printer's marks to image on the finished sheet, as shown in the following illustration.

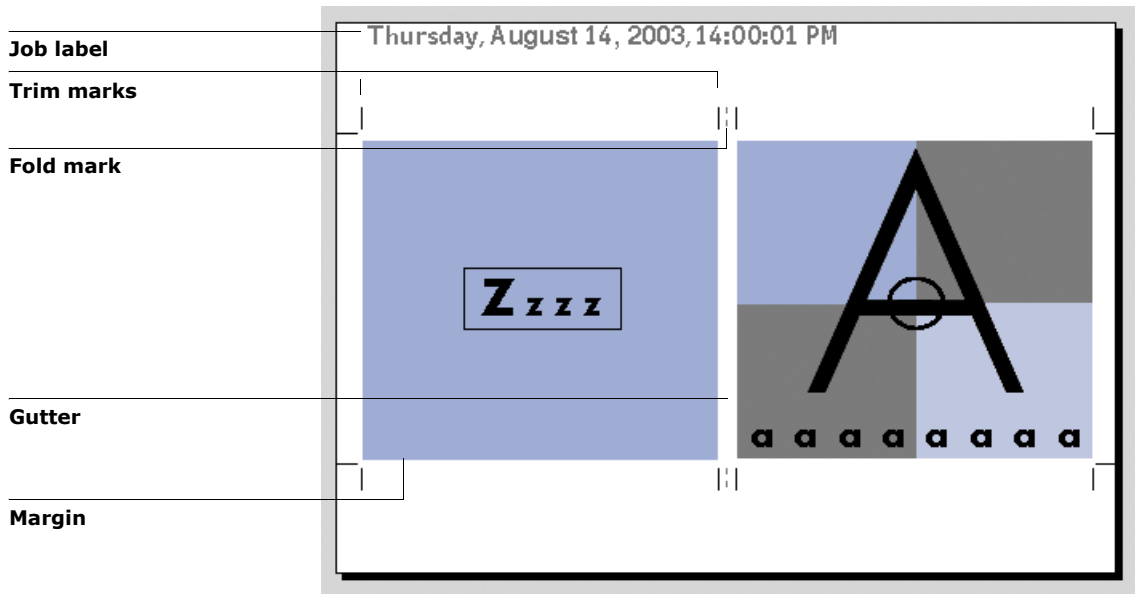

### Additional sheets

A book layout must also adjust the placement of pages according to the total number of pages in the job. For example, a book is often composed of more pages than can be printed on a single sheet. When the number of pages in the book is a multiple of the number of pages on a sheet, the same layout plan is used to place pages on additional sheets, until all of the pages in the book are printed. However, if the total page count is not an even multiple of the number of pages in the layout, one signature may be laid out to accommodate the discrepancy.

For example, if your layout places 8 pages on a sheet and the total page count in the book is 12, one of its signatures holds only 4 content pages, with the rest of the space on the sheet blank. If you do not want blank pages in the middle of the finished book,

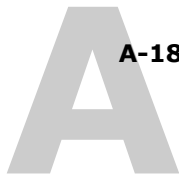

insert blank pages intentionally, for example after the cover page, after the table of contents, or between chapters. To insert blank pages, open the job in the Thumbnail A window, right-click the page you want to add the blank to (or pull down the Page menu), and select Insert blank page.

DocBuilder Pro allows you to add blank pages or add, delete, and rearrange pages from multiple source documents easily, so you can quickly preview the results of page manipulations.

## Binding methods

A book layout also specifies the means by which sheets are gathered and bound. Stitching or stapling finished pages across a common center fold, or spine, is called saddle stitch binding, and the stitched pages are called a saddle. Multiple folded sheets can be stitched into the same saddle as a group. Stacking signatures, grinding the spines off, and then gluing them together is called perfect binding. You can combine saddle stitch and perfect binding methods by stacking two or more groups one on top of another on a common fold line and gluing them together; this is called a nested saddle.

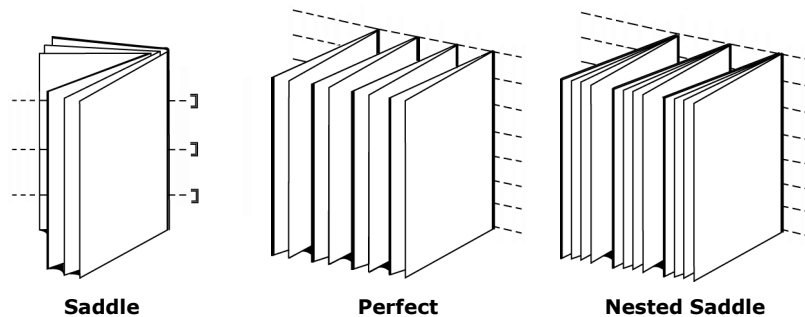

The binding method you use affects the order in which pages are placed on the sheet; for example, the page ordering used to perfect bind a book must be different from that used to saddle stitch the same job. Thus, your layout must specify the method by which the finished job will be bound.

The choice of a binding method is determined by the job's size, complexity, and budget. Saddle stitch binding is very cost-efficient, but is more suitable for small booklets than for large jobs. (A rule of thumb is that saddle stitch binding works best for booklets or brochures with a maximum of 88 pages.) Conversely, perfect binding is more expensive but more suitable for larger jobs.

DocBuilder Pro reorders imposed pages automatically according to your choice of binding method, which can save a significant amount of time and effort. Consider, for example, what must be done when a book that was to be saddle stitched exceeds the bindery's maximum page count and must be reimposed as a perfect-bound book. To redo the imposition by traditional means would be labor- labour-intensive; with DocBuilder Pro, it takes only moments.

### Shingling and creep

All books and brochures use a sheet that is folded to create separate page areas. Because the sheet itself has some thickness, each fold causes a very small incremental shift in the location of the edge of each page relative to the others. The result is that the edges of pages furthest from the saddle's innermost fold seem to move away from the edges of pages closest to the innermost fold. As the number of pages in the saddle increases, so does the amount of this shift, which is known as shingling. To counteract the effects of shingling (illustrated in an exaggerated manner in the following figure), the bindery trims the edges of the finished book to a common edge.

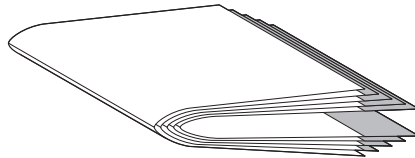

**Shingli**

Trimming the bound pages resolves only half of the problem, however—as the edges of pages move, so do the content areas imaged on them. The apparent shift of content area caused by folding a sheet multiple times is known as creep or binder's creep. The effect of creep is that the content area of pages closer to the innermost fold in a saddle appear to move towards the outer margins of the page.

# A

Creep becomes more noticeable as the number of groups in a saddle increases, and its effect is most noticeable on pages farthest from the center fold of the saddle. Consequently, a book layout must also specify the number of groups in each saddle because the number of groups in each saddle affects the amount of creep that needs to be accounted for.

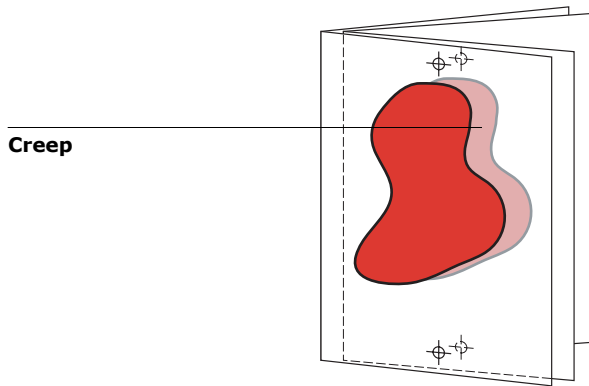

Compensating for creep is tedious, exacting work that DocBuilder Pro does for you automatically when you change any aspect of the imposed job that is affected by creep.

### Gang-Up printing

Layout is essential for defining the elements of complex print jobs such as booklets and books, but it can also be useful for smaller jobs. Consider, for example, how you might approach the task of printing business cards. It is slow, wasteful, and expensive to print a single business card per sheet, when you can repeat the image of the business card until the entire sheet is filled. This printing technique is known as Gang Up Repeat because the image is repeated in each page area, or step, on the sheet. After

printing, the sheet is cut apart to produce individual cards.

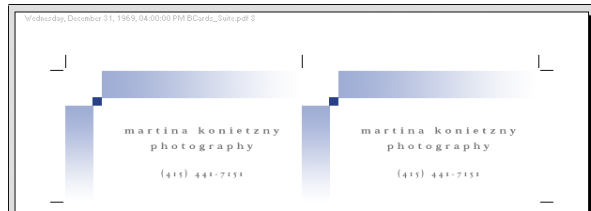

**Gang Up Repeat layout**

This job can be made even more efficient by eliminating the gutters between cards, allowing you to reduce significantly the number of cuts required to separate each card from its neighbour. Defining zero-width gutters on a shared cut line in this manner is called using a common blade for those cuts.

If you need to print business cards for several different clients, you could perform a Gang Up Repeat printing job for each, but you might still wind up wasting paper and time if the jobs do not fit easily into a simple multiple of sheets. A more efficient approach is to print several jobs on a single sheet, and then print that sheet as many times as required. The technique of printing



# A

## A-193 Printing books with the Imposition feature of DocBuilder Pro

multiple jobs on the same sheet is known as Gang Up Unique. DocBuilder Pro provides both Gang Up Repeat and Gang Up Unique.



**Gang Up Unique layout**

## Appendix B: Templates

- 1 This appendix gives descriptions of the built-in templates provided with DocBuilder Pro.

### 1-Up Full Bleed

The 1-Up Full Bleed layout is used to print one page per sheet. The printer's marks indicate where to cut the paper so that the color content extends to the edge of the paper.

The following settings are applied for this layout:

- Bleeds
- Printer's Marks (trim marks and job label only)
- Scale to Fit
- Gang Up Unique

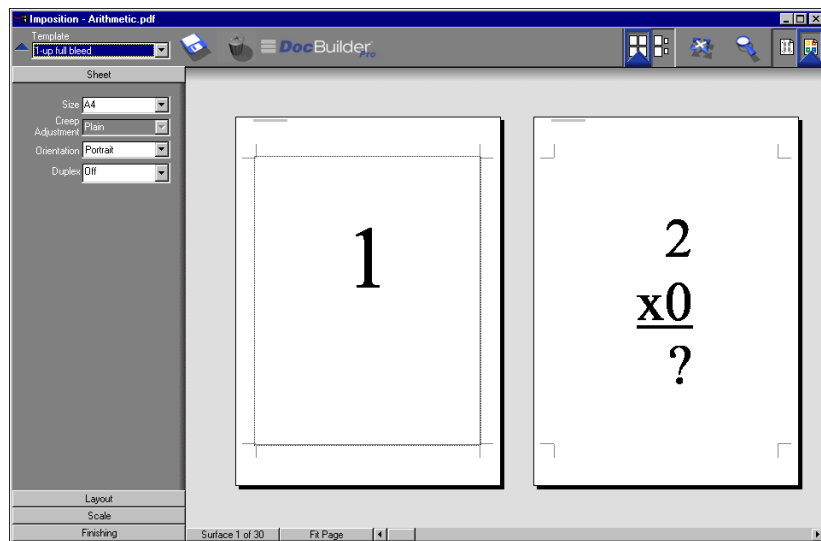

**Note:** There are no page number restrictions for the 1-Up Full Bleed layout.

## 2-Up Perfect

The 2-Up Perfect layout is used to create signatures for a perfect bound book. Each sheet is folded once and stacked on top of one another. For more information on binding methods, see [page A-189](#).

The following settings are applied for this layout:

- Duplex
- Bleeds
- Printer's Marks (fold marks, trim marks, and job label)
- Scale to Fit
- Binding Perfect

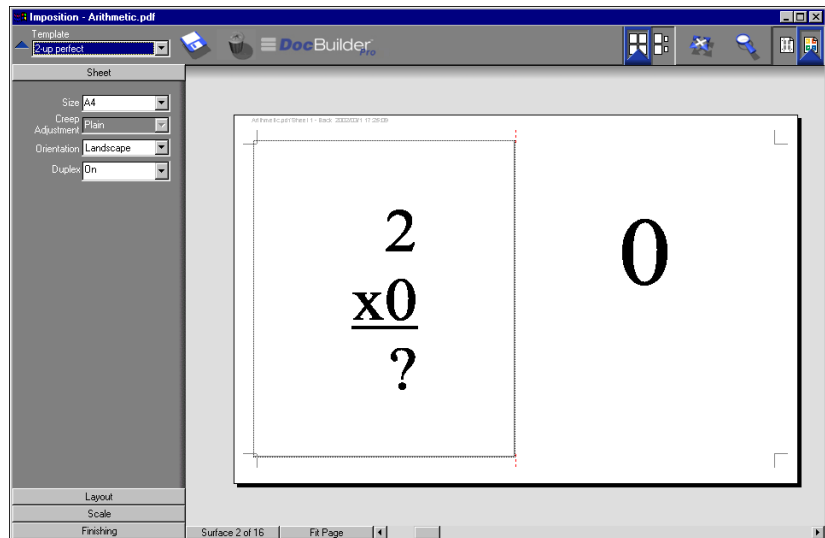

The 2-Up Perfect layout should be used with jobs that have multiples of four pages, but it can be used with jobs that have any number of pages. Additional blank pages will be added if necessary. Pages will be ordered in groups of four so that when folded each sheet has four sequential pages. For example:

- 4 pages

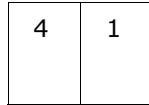

**Sheet 1,  
front side**

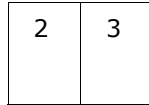

**Sheet 1,  
back side**

- 8 pages

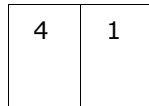

**Sheet 1,  
front side**

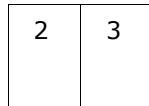

**Sheet 1,  
back side**

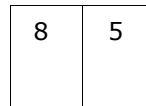

**Sheet 2,  
front side**

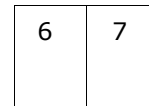

**Sheet 2,  
back side**

**Note:** The Creep Adjustment option has no effect on this template.

## 2-Up Saddle

The 2-Up Saddle layout is used to create sheets for a saddle bound book. All of the sheets are folded together, one inside the other. For more information on binding methods, see [page A-189](#).

The following settings are applied for this layout:

- Duplex
- Bleeds
- Printer's Marks (fold marks, trim marks, and job label)
- Scale to Fit
- Binding Saddle

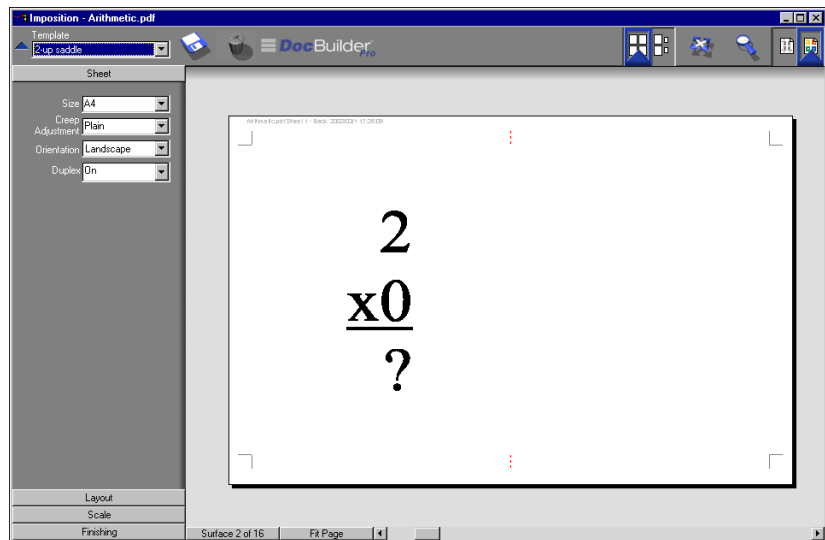

The 2-Up Saddle layout should be used with jobs that have multiples of four pages, but it can be used with jobs that have any number of pages. Additional blank pages will be added if necessary. Pages will be ordered so that when sheets are folded and stitched together, the pages will be sequential. For example:

- 4 pages

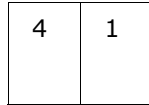

**Sheet 1,  
front side**

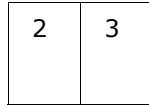

**Sheet 1,  
back side**

- 8 pages

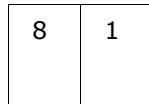

**Sheet 1,  
front side**

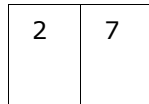

**Sheet 1,  
back side**

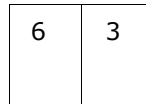

**Sheet 2,  
front side**

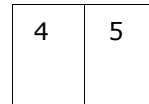

**Sheet 2,  
back side**

## 3-Up Trifold Brochure

The 3-Up Trifold Brochure layout consists of a single sheet folded into three sections. Although the three sections are the same width, the space between each section varies so that the leftmost panel can be folded over the other two panels.

The following settings are applied for this layout:

- Duplex
- Printer's Marks (fold marks, trim marks and job label only)
- Scale to Fit
- Gang Up Unique

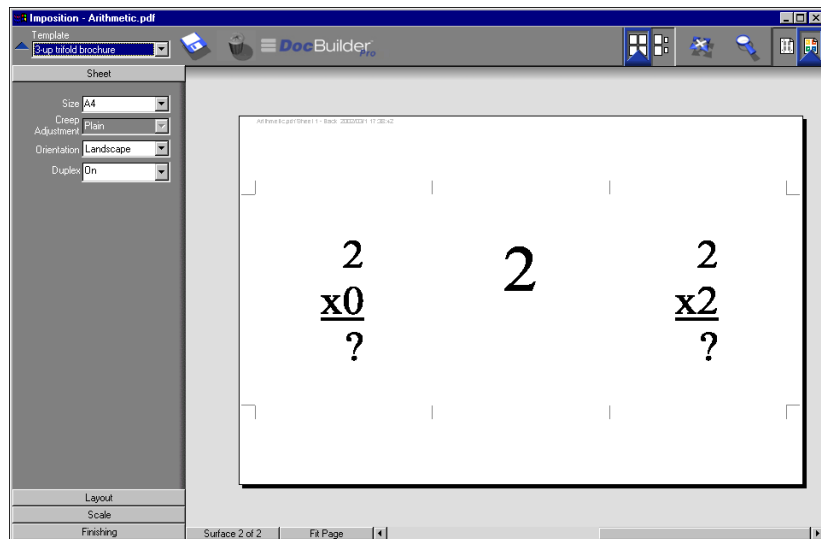

The 3-Up Trifold Brochure layout can be used only with jobs that have six pages. If the job contains more or less than six pages, an error message appears. The pages will be ordered as follows:

3	6	1
---	---	---

**Sheet 1,  
front side**

2	4	5
---	---	---

**Sheet 1,  
back side**

The 3-Up Trifold Brochure is usually folded as shown in the following illustration.

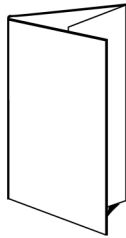



## 4-Up Gate Fold

The 4-Up Gate Fold layout is used most often in the case of a four-panel brochure. The finished brochure unfolds to double, then four times the original size.

The following settings are applied for this layout:

- Duplex
- Printer's Marks (fold marks, trim marks and job label only)
- Scale to Fit
- Gang Up Unique

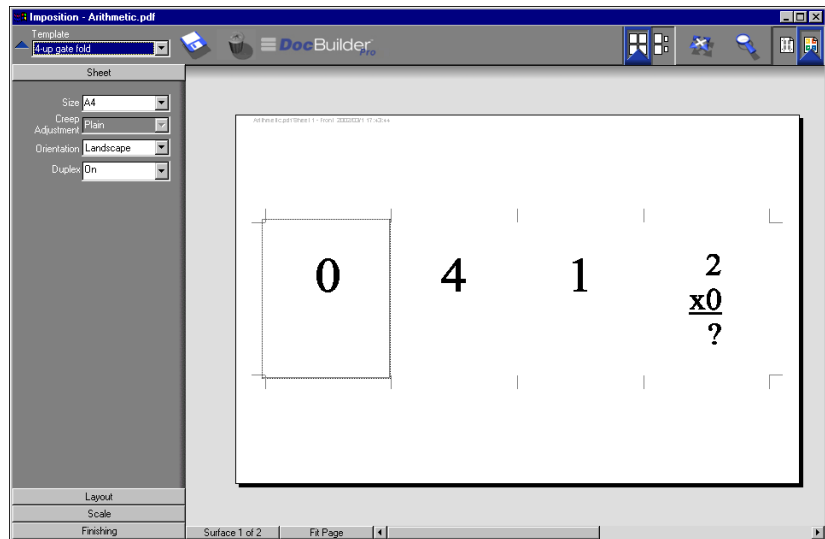

The 4-Up Gate Fold layout can be used only with jobs that have eight pages. If the job contains more or less than eight pages, an error message appears. The pages will be ordered as follows:

3	8	1	2
---	---	---	---

**Sheet 1,  
front side**

4	5	6	7
---	---	---	---

**Sheet 1,  
back side**

The 4-Up Gate Fold is usually folded as shown in the following illustration.

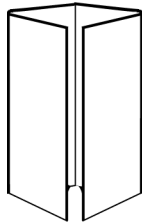

## 4-Up Head to Head

The 4-Up Head to Head layout is used to create booklets from a layout of four pages on each side of the printed sheet. By rotating the two topmost pages, the signature can be folded both horizontally and vertically, and trimmed. The finished booklet will have all pages in the correct order and rotation.

The following settings are applied for this layout:

- Duplex
- Bleeds
- Printer's Marks (fold marks, trim marks, and job label)
- Scale to Fit
- Binding Saddle

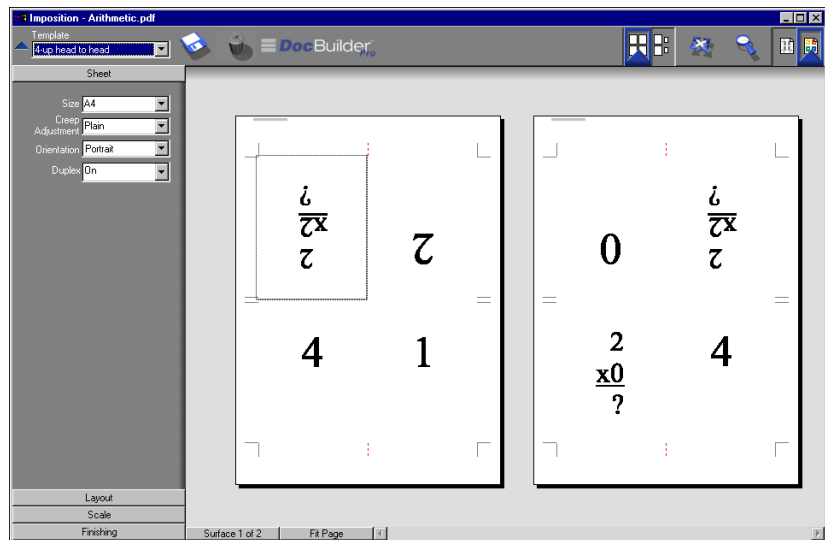

The 4-Up Head to Head layout should be used with jobs that have multiples of eight pages, but it can be used with jobs that have any number of pages. Additional blank pages will be added if necessary. Pages will be ordered so that when sheets are folded

with two folds at 90 degrees, trimmed, and stitched together into signatures, the pages will be sequential. Note that although this layout requires two folds, the template applies a fold mark on the spine fold only. For example:

- 8 pages

5	4
8	1

**Sheet 1,  
front side**

3	9
2	7

**Sheet 1,  
back side**

- 16 pages

9	8
16	1

**Sheet 1,  
front side**

7	10
2	15

**Sheet 1,  
back side**

11	9
14	3

**Sheet 2,  
front side**

5	12
4	13

**Sheet 2,  
back side**

The 4-Up Head to Head is usually folded as shown in the following illustration.

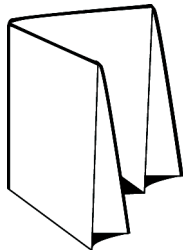

## 4-Up Z-Fold

The 4-Up Z-Fold layout allows many panels to be folded on top of one another without stressing the folded spine. The most common example is a road map.

The following settings are applied for this layout:

- Duplex
- Printer's Marks (fold marks, trim marks and job label only)
- Scale to Fit
- Gang Up Unique

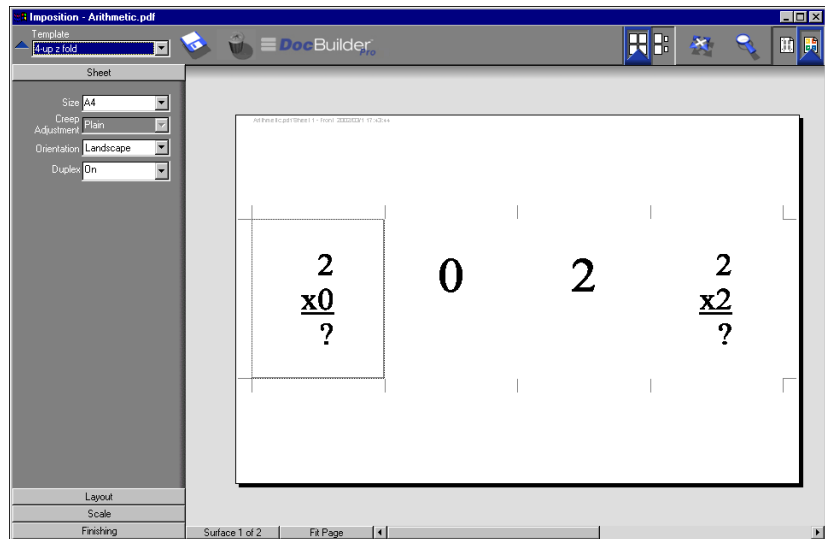

The 4-Up Z-Fold layout is used only for jobs that have eight pages. If the job contains more or less than eight pages, an error message appears. The pages will be ordered as follows:

2	3	4	5
---	---	---	---

**Sheet 1,  
front side**

6	7	8	1
---	---	---	---

**Sheet 1,  
back side**

The 4-Up Z-Fold is usually folded as shown in the following illustration.





## **Appendix C: Troubleshooting**

This appendix describes error messages you might see, and provides some troubleshooting guidelines should a problem arise with the Fiery, Command WorkStation LE, or Command WorkStation. If you are unable to resolve a problem after referring to this chapter, contact your Oki dealer.

### **Error messages**

Error messages can result from problems with the job, the Fiery, Command WorkStation, Command WorkStation LE, Fiery Spooler, or the printer. When an error interferes with printing, you will see a message in the Activity Monitor of Command WorkStation or Command WorkStation LE. The status bar that displays the message indicates the process in which the error occurred.

An error message for the Fiery sometimes remains displayed on Command WorkStation or Command WorkStation LE even after you resolve the error. There might be a brief delay while the Fiery communicates the resolution of the error to the application. Printing will resume and the Command WorkStation or Command WorkStation LE window will be updated after a short delay.

For information on resolving printer-related errors, refer to the ES3640e MFP User's Guide. You can cancel the pending print job while you attend to a given error condition.



## Troubleshooting

Before you call for service, follow the suggestions in this section. If you are unable to resolve the problem, make a note of the error condition and contact your Oki dealer.

### **Command WorkStation or Command WorkStation LE does not respond**

If the Command WorkStation or Command WorkStation LE windows do not update, log off and then quit Command WorkStation or Command WorkStation LE. Restart Command WorkStation or Command WorkStation LE, or restart the computer. To force an exit from Command WorkStation, press Ctrl-Alt-Delete, and use the Task Manager to close Command WorkStation.

If the Command WorkStation or Command WorkStation LE windows do not update, or no jobs are displayed, and the mouse has no effect (you cannot select a job or a window, use a right mouse command, or choose a menu item), the Fiery is down or network communication has failed.

At the ES3640e MFP, disconnect and reconnect the network cable, and try printing a Test Page or Configuration page. If that fails, restart the server.





## Unexpected printing results

If this happens	This is the problem
The job settings are not carried out as you expected.	If the user printed from Apple Mac OS, there may be two conflicting print settings. You can check the job properties by double-clicking the job. For a table of job properties and conflicting properties, see Appendix A of the <a href="#">Printing Guide</a> . Notify users of these conflicts so they can avoid them in the future. If you expected the settings you see in the Properties window, be aware that the Copies field does not currently reflect user settings, and that Page Range and Scale percent are All and 100%, respectively, unless they were changed after being sent for printing.
The job does not print.	Some printing errors may be displayed in the Print status bar. When the job is in the Printed queue, jobs that had a PostScript error are displayed in a light red job row. Double-click anywhere in the row to see the error message.
There are font errors.	If user-specified fonts that are not resident on the Fiery are not printing correctly in PostScript files that are downloaded by users, request that they embed the fonts in the PostScript file or print directly from their application. If special fonts are not downloaded automatically when users print from applications, the fonts should be downloaded directly to the Fiery with Fiery Downloader. This can be done by the user or the operator, provided the Direct connection is enabled. For information about Fiery Downloader, see Chapter 4 of the <a href="#">Printing Guide</a> .



## Clearing the server

Clearing the server is an Administrator option that can be used as a last resort if a job persists in the system and prevents printing despite attempts to cancel or delete it. Clear the server if all other troubleshooting methods have failed.

You can clear the server by using the Server>ClearServer command in Command WorkStation or the Server>Clear Server command in Command WorkStation LE. In Command WorkStation, you can delete the following jobs individually: held jobs, active jobs, printed jobs, archived jobs, FreeForm masters, and scan jobs.

## Users are unable to connect to the Fiery

If users are unable to connect to the Fiery, or are unable to find the Fiery from their workstations, the network administrator may need to troubleshoot their network connections, and check settings on the servers they use for printing. If settings have changed, it may be necessary to reconfigure the Fiery.

For example, if print servers or print queues on a Novell server are renamed or deleted, or if accounts or permissions are changed, the Fiery administrator may have to edit settings or enter new settings in IPX (Novell) Setup to reflect the new configuration.

If users cannot connect to the Fiery with Fiery Downloader from a Windows client computer, you may need to reconfigure the utility's connection to the server. For details, see Chapter 1 of the [User Software Installation Guide](#).

Mac OS users may be unable to connect to the Fiery if a network administrator has assigned it to a different zone, or has added zones where previously there were none.



If you have configured the Fiery and set up client computers and network servers according to guidelines in the [Configuration Guide](#) and the [User Software Installation Guide](#), try printing a Test Page (in Command WorkStation or Command WorkStation LE, choose Print Pages from the Server menu).

If you can print the Test Page but still cannot print a document from a remote computer, contact the system administrator to troubleshoot the network connection.

If you are unable to connect, and you *cannot* print the Test Page, check the ES3640e MFP control panel display.

<b>If this happens</b>	<b>Try this</b>
The printer is not in Standby mode.	The printer's Automatic Power-Off function may have shut down the printer. Turn the printer on, and then try printing a Test Page again when the printer has warmed up.
You still cannot print a Test Page.	Make a copy. If you can make a copy, restart the Fiery, and when you see Ready to Print on the ES3640e MFP control panel display, try printing a Test Page again. If the Test Page still fails to print, contact your Oki dealer.

### Setup error messages

For information on Setup error messages, see Appendix A of the Configuration Guide.

# Index **I-212**

## Index

### A

- Acrobat 6-148
- Action buttons 2-38, 3-78
- Active Jobs window
  - job ticket information 3-72
  - monitoring jobs 3-71
  - overview 2-28
  - printing job list 2-55
- Activity monitor
  - All Servers view 2-34
  - overview 2-32
  - Selected Server view 2-34
- activity states, defined 2-36
- Administrator
  - password 3-68, 3-69
- aligning pages 6-139
- aligning trays 2-58
- applying templates 5-127
- Archive command 3-94
- archive log 2-55
- Archive panel
  - archiving jobs 3-95
  - overview 2-31
- Autologin preference 2-56, 2-57

### B

- binder's creep
  - adjusting 6-132
  - compensating for
    - automatically 6-141
  - effects A-190
  - groups 6-142
  - sheet thickness 6-132
- binding offset 6-154
- binding options 6-140
- binding styles
  - nested saddle 6-141, A-189
  - perfect 6-141, A-189

- saddle stitch 6-141, A-189
- bleeds
  - printer's marks A-186
  - setting 6-136

### C

- Cancel Printing command 7-161
  - from Command WorkStation 3-86
- Cancel Processing command 3-86
- Cancel RIPping command 7-161
- chapters, forcing 3-88
- Clear command
  - archived jobs C-210
- clipping icon 6-133, 6-139
- clipping indicators
  - Layout mode 6-139
  - Preview mode 6-139
- clipping views 6-139
- collate and cut finishing 6-142
- Color Charts 2-55
- columns
  - scaling 6-138
  - setting 6-134
- command menus, *see* menus
- Command WorkStation
  - layout styles 2-39
  - logging in 3-66
  - logging out 3-70
  - menus 2-42
  - overview 1-23
  - preferences 2-56
  - user interface,
    - customizing 2-40
  - user interface,
    - explained 2-25, 2-26, 2-27
  - windows 2-25, 2-26, 2-27
- Command WorkStation LE

- logging in 3-67
- logging out 3-70
- menus 2-42
- overview 1-23
- preferences 2-57
- troubleshooting C-208
- user interface, explained 2-27
- windows 2-27
- communicating print requirements 1-20
- Configuration page 2-55
- context-sensitive menus 2-50
- copiers/printers and duplex printing A-184
- Create Master option 3-89 to 3-90
- creep, *see binder's creep*
- custom template limitations 6-152

**D**

- date 6-135
- Define Marks dialog box 6-135
- Delete command 4-108, 7-173
- Delete Job(s) command 7-161
- Delete Template icon 6-153
- Direct
  - connection 1-17, 2-61, 3-76, 3-78, C-209
- Direct queue 1-17, 2-61, 3-76, 3-78
- DocBuilder Pro 3-96
- duplex printing
  - copiers/printers A-184
  - defined A-184
  - enabling 6-133
  - print options A-184
- duplexing 6-133
- Duplicate (page)
  - command 4-107, 7-173
- Duplicate Job(s) command 7-162

**E**

- editing page content 6-148
- Enable Animation preference 2-56
- error messages
  - during Setup C-211
  - general C-207
- errors 7-160

**F**

- Fiery Spooler
  - interface 7-156
  - overview 1-24
- Fiery WebSpooler
  - raster data 7-161
- Fiery WebTools 1-20
  - home page 7-158
- files, temporary 6-154
- Find command
  - defined 3-97
  - search templates 3-102
  - templates folder 2-57
- Finishing settings
  - Binding 6-141
  - Gang Up 6-142
  - imposition window 6-140
- Fit Page command 5-125
- Fixed Page
  - mode 5-121, 6-129, 6-138, 6-139
- Fold Marks 6-135, A-186
- folding model
  - creating A-183
  - defined A-185
- Font Substitution Table 2-61
- fonts
  - Adobe Type 1 2-61
  - downloading C-209
  - managing 2-61 to 2-63
  - printer fonts on server 2-63
  - printing font list 2-55
  - TrueType 2-61

- FreeForm
  - Create Master option 3-89 to 3-90
  - creating masters 3-89 to 3-90
  - deleting masters 3-91
  - overriding master
    - numbers 3-90, 3-92
  - printing variable data
    - documents 3-89
  - Use Master option 3-89
- FreeForm panel 2-31
- G**
- gang printing
  - enabling 6-142
  - Repeat option 6-142
  - suggested uses 6-142
  - Unique option 6-143
  - Unique-Collate Cut option 6-143
- Gang Up Repeat A-191
- Gang Up Unique A-193
- Go To Surface dialog box 5-126
- group
  - binder's creep 6-142
  - defined A-189
- Guest access 3-69
- gutters
  - defined A-186
  - defining size 6-151
  - location of 6-151
  - perfect binding 6-151
  - saddle-stitched binding 6-151
- H**
- held jobs 7-166
- Hold command 3-79, 7-162
- Hold queue 1-17, 3-75, 3-78
- I**
- icons
  - clipping 6-133, 6-139
  - Delete Template 6-153
  - Print area 7-167
  - RIP area 7-166
  - Save Template 6-153
  - Spool area 7-165
- importing jobs 3-75
- imposing jobs 5-117
- imposition
  - data and temporary files 6-155
  - page reordering 6-145
  - saving 6-155
  - saving settings as
    - template 6-153
  - settings 6-153
  - templates folder 2-57
- Imposition Template Path preference 2-57
- imposition window
  - clipping indicator 6-139
  - controls 6-131
  - Finishing settings 6-140
  - Fixed Page mode 5-121
  - Layout mode 5-122
  - Mixed Page mode 5-121
  - navigating 5-120, 5-121
  - opening 5-117
  - Orientation menu 6-132
  - preview mode 5-122
  - printer's spread 5-118
  - reader's spread 5-118
  - reordering pages 6-145
  - rows menu 6-133
  - Scale settings 6-137
  - size menu 6-132
  - template menu 5-127
  - view modes 5-122
- inches, abbreviation and keyboard shortcut 6-131
- Insert blank page
  - command 5-116
- Instructions field 1-22, 3-80, 3-81

**J**

## job

- canceling 3-86
- editing content of 6-148
- importing 3-75
- imposing 5-117
- imposition data 6-155
- limit 7-167
- monitoring 3-71
- overrides 3-80, 7-163
- previewing 4-104, 4-105, 4-107, 7-168, 7-172, 7-173
- saving imposed 5-128
- searching for 3-97
- selecting 3-71
- sorting 3-72
- temporary files 2-57, 6-154
- transferring to another server 3-85

## job environment

- defined 1-16
- operator-controlled 1-17

## job flow

- communicating print requirements 1-20
- diagram 1-19
- monitoring 3-71
- overview 1-17
- status indicators 2-36

## job icons

- Print area 7-167
- RIP area 7-166
- Spool area 7-165

## Job label

- date 6-135
- defined 6-135, A-186
- job name 6-135
- sheet information 6-135
- time 6-135

## Job Log

- displaying 7-176

- exporting to a file 3-97

- panel 2-32, 3-96

- printing 2-55, 3-96

- using 7-176

- viewing printed jobs 7-160

- Job menu commands 7-161

- job name 6-135

- Job Properties dialog box 3-90

- Job status indicators 2-36

## job ticket

- customizing 3-72

- defined 1-21

- sorting by 3-72

## Jobs window

- job ticket information 3-72

- overview 2-30

**L**

## layout

- bleeds 6-136

- defined 6-133, A-185

- maximum number of

- pages 6-133

- rows in 6-134

## layout mode

- characteristics 5-122

- clipping indicators 6-139

- defined 5-122

- reordering pages 6-145

- Zoom tool disabled 5-123

## Layout settings

- Bleeds 6-136

- Columns 6-134

- Printer's Marks 6-134

- rows 6-133

## layout styles in Command

- WorkStation 2-39

## layout view 6-145

## load balancing between

- servers 3-85

## logging in

- to Command WorkStation 3-66
- to Command WorkStation  
LE 3-67
- logging out
  - from Command  
WorkStation 3-70
  - from Command WorkStation  
LE 3-70
- Login Server
  - removing servers 3-70
- Login Server window
  - logging in 2-51

**M**

- Manage Fonts command 2-61
- margins 6-152, A-186
- measurement, setting units  
of 2-57
- menus
  - Command WorkStation 2-42
  - Job 5-117
  - Orientation 6-132
  - Rows 6-133, 6-134
  - Size 6-132
  - Template 5-127
  - View 5-122, 5-123
- merging files 7-174
- millimeters 6-131
- mixed media 3-88
- Mixed Page
  - mode 5-121, 6-129, 6-135, 6-137, 6-138, 6-139
- monitoring jobs 3-71
- monitoring servers 2-38
- multiple servers
  - balancing load between 3-85
  - monitoring 2-38
  - working with 3-85

**N**

- nested saddle 6-141, A-189

- newlink PrintPages 2-53
- Notes
  - fields 1-21, 1-22, 3-80, 3-81

**O**

- offsetting pages 6-139
- Operator password 3-68, 7-157
- operator-controlled environment,  
setting up 1-17
- orientation, setting 6-132
- Override Print Settings
  - command 7-163
- overriding print settings 3-80

**P**

- page
  - aligning on sheet 6-139
  - Fixed Page
    - mode 6-129, 6-138, 6-139
  - maximum number in  
layout 6-133
  - Mixed Page
    - mode 6-129, 6-135, 6-137, 6-138, 6-139
  - numbers in layout view 6-145
  - reordering automatically A-190
  - reordering on sheet 6-145
  - rotating 6-149
  - viewing individual 5-123
- page numbers 6-145
- passwords
  - Administrator 3-68
  - for Command WorkStation  
access 3-69
  - for Command WorkStation LE  
access 3-68
  - Operator 3-68, 7-157
- PCL
  - font list 2-55
  - test page 2-55



- PCL (Printer Control Language) 4-15
- perfect binding
  - defined 6-141, A-189
  - gutters 6-151
- permissions 3-69, C-210
- PitStop 6-148
- points 6-131
- PostScript
  - font list 2-55
  - icon 7-164
- preferences, for Command WorkStation 2-56
- Preview command 4-107
- preview mode
  - characteristics 5-122
  - clipping icon 6-139
  - defined 5-122
- Preview windows
  - Delete command 4-108
  - editing options 4-108
  - overview 2-38
- previewing
  - jobs 4-104, 4-105, 4-107, 7-168, 7-172
- Print and Hold
  - command 1-20, 3-79, 7-162
- Print area 7-167
- Print command 1-19, 3-79, 7-162
- print options
  - mixed media 3-88
- Print Pages command 2-53
- Print queue 1-17, 3-75, 3-78
- print requirements,
  - communicating 1-20
- print settings
  - Create Master option 3-89 to 3-90
  - overriding 3-80
  - Use Master option 3-89, 3-92
- printed jobs 7-160
- Printed Jobs panel 2-30, 3-71
- Printed queue 7-167
- printer (job) icon 7-164
- Printer Control Language (PCL) 4-15
- printer fonts, *see* fonts
- printer's marks
  - bleeds A-186
  - customizing 6-136
  - date 6-135
  - defining 6-135
  - disabling 6-135, 6-136
  - enabling 6-134
  - Fold Marks 6-135, A-186
  - gutters A-186
  - job label 6-135, A-186
  - job name 6-135
  - margins A-186
  - overview A-186
  - properties 6-136
  - sheet information 6-135
  - time 6-135
  - Trim Marks 6-135, A-186
- printer's spread 5-118
- printing
  - Active Jobs list 2-55
  - archive log 2-55
  - Color Charts 2-55
  - Configuration page 2-55
  - error 7-167
  - font list 2-55
  - in job flow 1-18
  - Job Log 2-55
  - queues list 2-55
  - test page 2-55
- printing duplex 6-133, A-184
- problems, *see* troubleshooting
- Process and Hold
  - command 1-20, 3-79
- Process Next command 7-162
- processing

- in job flow 1-18
- Properties command 3-80, 3-90
- PS Test Page 2-55

**R**

- raster
  - data 7-161, 7-166
  - icon 7-164
- raster files 1-18
  - archiving 3-95
  - editing 7-172
  - icon 3-71
  - previewing 7-168
  - saving an edited
    - document 7-174, 7-175
  - status on server 3-79
- reader's spread 5-118
- Redo command 4-108
- remote users C-210
- Remove Raster command 7-162
- Remove Raster Data
  - command 3-79
- Rename command 7-162
- reordering pages
  - automatically A-190
  - layout mode 6-145
- Resume Printing command 3-86
- right-click menus, *see* context-sensitive menus
- RIP and Hold
  - command 1-20, 7-162
- RIP area 7-166
- RIPped jobs 7-160
- rotating pages 6-149
- rows
  - clipping of content area 6-133
  - layout setting 6-133
  - scaling 6-138
  - selecting number in
    - layout 6-134
- Rows menu 6-134

**S**

- saddle
  - defined 6-141, A-189
- saddle stitch binding
  - characteristics of 6-141
  - creep 6-132
  - defined A-189
  - groups A-189
  - gutters 6-151
- Save As dialog box 5-128
- Save Template icon 6-153
- Scale settings 6-137
  - Alignment and Offsets 6-139
  - Apply To 6-138
  - Scale Mode 6-138
- scaling selected pages 6-138
- Search Template Path
  - preference 2-57
- searching for jobs 3-97
- selecting jobs 3-71
- Send to server command 3-85
- server
  - aligning trays 2-58
  - clearing C-210
  - load balancing 3-85
  - logging in from Command WorkStation 3-66
  - logging in from Command WorkStation LE 3-67
  - logging out from Command WorkStation 3-70
  - logging out from Command WorkStation LE 3-70
  - managing multiple servers 3-85
  - monitoring 2-38
  - printing information
    - pages 2-53
  - RAM requirements 3-66
  - selecting 2-38

- working with more than one 3-85
  - server fonts, *see* fonts
  - sheet
    - defined 5-119, A-183
    - number of rows 6-133
    - orientation 6-132
    - reordering pages 6-145
    - size 6-132
    - slot 6-138
    - thickness 6-132
    - viewing by number 5-126
    - viewing entire 5-125
  - sheet information 6-135
  - Sheet settings 6-131
    - Creep Adjustment 6-132
    - Duplex 6-133
    - Orientation 6-132
    - Size 6-131
  - sheet size, setting 6-131
  - shingling A-190
  - Show Animations preference 2-58
  - Show Import Options Dialog
    - preference 2-58
  - signature A-183
  - simplex printing A-184
  - slot 6-138
  - sorting jobs 3-72
  - source file 7-172
  - spine A-189
  - Spool area 7-165
  - spooled jobs
    - icons 7-165
  - spooling
    - in job flow 1-18
  - status bars
    - Print 7-159
    - RIP 7-159
    - Spool 7-159
  - status indicators, defined 2-36
  - step-and-repeat printing 6-142
  - surface
    - defined 5-119
    - navigating to selected 5-122
    - slot 6-138
  - Surface menu 5-122
- ## **T**
- target file 7-172
  - template
    - applying 5-127
    - defined 5-126
    - deleting 6-153
    - limitations 6-152
    - saving 6-153
    - saving imposition
      - settings 6-153
    - selecting 5-127
  - Template menu 5-127
  - temporary files 6-154
  - temporary folder, for job files 2-57
  - Temporary path preference 2-57
  - Test Page
    - printing C-211
    - problem printing C-211
  - test page 2-55
  - Thumbnail A
    - command 7-163
    - Delete command 7-173
    - Duplicate command 7-173
    - editing options 7-173
    - page commands 7-172
    - page display 7-168
    - window 7-172
  - Thumbnail B 7-172
    - command 7-163
  - time 6-135
  - Tray Alignment command 2-58
  - Trim Marks 6-135, A-186
  - troubleshooting
    - Command WorkStation
      - hangs C-208

- Command WorkStation LE
  - hangs C-208
  - general guidelines C-208
  - slow redraw 5-122
  - unexpected printing
    - results C-209
  - users are unable to connect to the printer C-210

## **U**

- Undo command 4-108, 7-173
- undo, in editing thumbnail views 4-112, 7-175
- Units preference 2-57, 2-58
- units, setting 2-57
- Use Master option 3-89, 3-92

## **V**

- variable data printing 3-89
- View menu 5-122, 5-123
- view modes
  - compared 5-122
  - layout 5-122
  - preview 5-122
- view only (Guest) access 3-69

## **Z**

- Zoom tool 5-123