

# LED Array with Higher Heat Dissipation by “Epitaxial Film Bonding” Technology

Tomohiko Sagimori Masataka Muto  
Hiroyuki Fujiwara Mitsuhiko Ogihara

Recently, there has been a growing demand for digital high-resolution high-speed office printers utilizing light-emitting diode (LED) as the printing light source. Key component of a digital LED printer is the optical write head (LED print head), which is a densely packed array of LEDs that act as source of light. For example, printing at 1,200dpi (dots per inch: number of pixels per inch of printing) on an A4 size paper, the light emission area is about  $8\mu\text{m} \times 8\mu\text{m}$ , LED array pitch about  $21.2\mu\text{m}$ , and number of concentrated LEDs about 10,000 dots.

LED emits light when charged carriers (electrons and holes) are injected through a p-n junction and recombined. Besides “radiative recombination” that emits light when the injected carriers are recombined, there is “non-radiative recombination” that emits no light. Instead of light, non-radiative recombination generates heat. Heat generated by LED operation leads to a rise in temperature that degrades luminous efficiency which in turn raises temperature even further.

LED array on a digital LED printer’s print head is densely arranged to accommodate as many LEDs as possible. More LEDs equate to higher resolution printing. Furthermore, electrical current to the print head is raised to increase light output of each LED thereby achieving higher print speeds. Unfortunately, these solutions work toward raising the temperature of the print head. Therefore, to develop high-resolution high-speed LED print heads, technology to dissipate heat and prevent temperature rise becomes important.

This article covers the LED material used in the print head and discusses a unique new technology for developing a high heat dissipation LED array.

## Development of the High Heat Dissipation LED Array

To achieve high LED heat dissipation, the distance between the light-emitting area and material with high thermal conductivity (thermal conductive substrate) should be minimized primarily to transfer the generated heat away from the light-emitting area quickly. Therefore, it is

desirable that the light-emitting area be placed as close as possible to the thermal conductive substrate.

A proprietary “epi film bonding” technology that enables direct bonding of single crystal semiconductor thin films to thermal conductive substrates is discussed in this chapter. The technology allows the development of a high heat dissipation LED array in which the distance between the light-emitting area and thermal conductive substrate is approximately  $1\mu\text{m}$ .

## Structure of the High Heat Dissipation LED Array

This section describes the structure of the high heat dissipation LED array. In fabricating LEDs, single crystal semiconductor layer (hereinafter referred to as thin film LED) is grown on a base substrate material using semiconductor crystal growing process such as Metal-Organic Chemical Vapour Deposition (MOCVD). Thin film LED is approximately  $2\mu\text{m}$  thick and the light-emitting layer is located about  $1\mu\text{m}$  from the surface. Therefore, if the thin film LED can be released from the base substrate and bonded directly to the thermal conductive substrate, a structure can be created in which the light-emitting area and thermal conductive substrate is a mere  $1\mu\text{m}$  apart.

An element, like a LED array on a print head, that independently controls numerous LEDs in a concentration requires each LED to be electrically isolated from the others. Si and metallic substrates are possible materials to serve as thermal conductive substrates. To use a metallic material as the thermal conductive substrate, an isolation film with high thermal conductivity (thermal conductive dielectric) is introduced between the thin film LED and thermal conductive substrate. Heat generated from the LEDs will transfer to the thermal conductive substrate without hindrance while electrical isolation between the LEDs and thermal conductive substrate is maintained thus facilitating the separation of the LED elements from each other.

**Figure 1** shows the layered structure of the high heat dissipation LED array described above. As shown in

**Figure 1**, thermal conductive dielectric is placed on top of the thermal conductive substrate, and the thin film LED is bonded directly on to the dielectric. With this structure, heat from the LED is quickly transferred through the dielectric to the thermal conductive substrate where it will be dissipated efficiently.

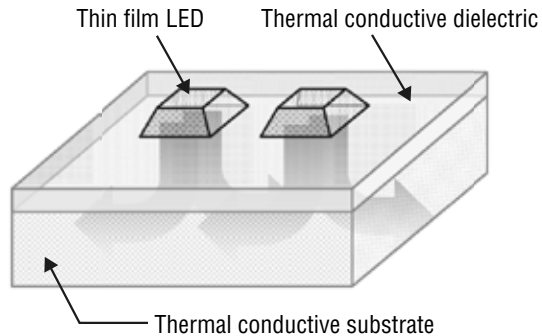

**Figure 1. Structure of the High Heat Dissipation LED Array**

### Technology Behind the High Heat Dissipation LED Structure

This section discusses the bonding of thin film LED to the thermal conductive dielectric/thermal conductive substrate using “epi film bonding” technology<sup>(1)2)</sup>.

#### (1) Thin film LED to thermal conductive substrate bonding process

**Figure 2** presents an overview of the process involved in bonding thin film LED to thermal conductive dielectric/thermal conductive substrate using “epi film bonding”, a technology in which single crystal semiconductor thin film is released from the base substrate then bonded on a dissimilar material utilizing intermolecular forces.

- (a) Material for the thin film LED used on print heads is  $Al_xGa_{1-x}As$  ( $x$  is the Al composition ratio), and base substrate used for the growth of  $Al_xGa_{1-x}As$  is GaAs. Thickness of the thin film LED is about  $2\mu m$ . A sacrificial layer is laid down between the thin film LED and GaAs substrate and later etched away to allow the thin film LED to be released. Light-emitting layer is located approximately  $1\mu m$  from the surface.
- (b) A predetermined island-like pattern is formed on the thin film LED to expose the sacrificial layer, and using an appropriate etching solution, only the sacrificial layer is etched away allowing the thin film LED to be released from the GaAs substrate.
- (c) A thermal conductive substrate with a film of thermal conductive dielectric is prepared beforehand. The thin film LED is pressed firmly against the pretreated

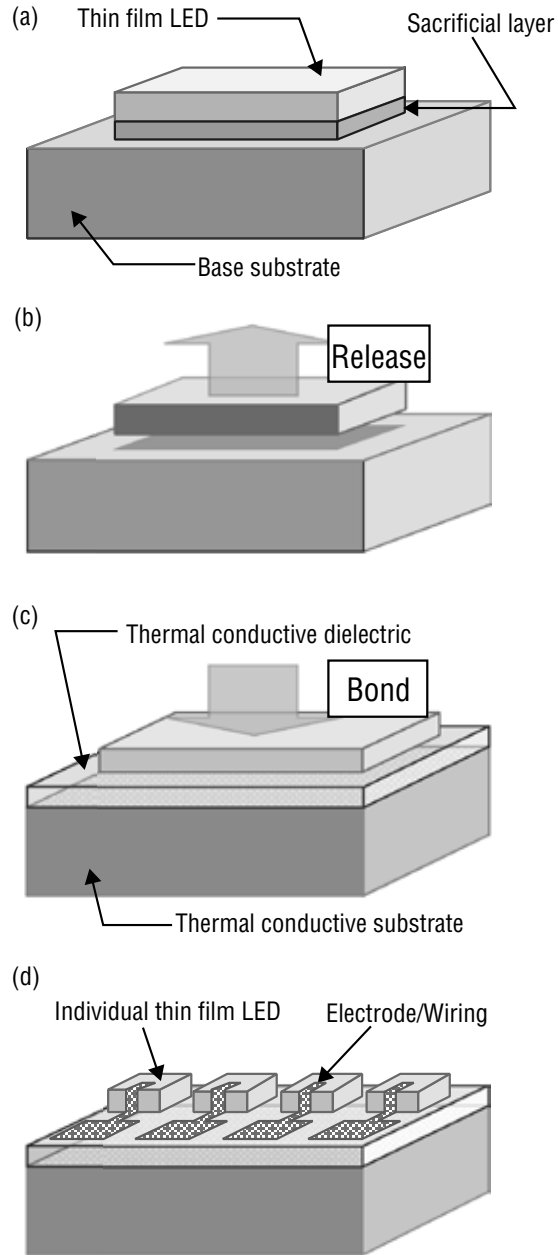

**Figure 2. Thin Film LED to Thermal Conductive Substrate Bonding Process and Thin Film LED Array Fabrication Process**

surface of the thermal conductive dielectric/thermal conductive substrate and bonded on to the dielectric without the use of adhesives.

- (d) The thin film LED bonded to the thermal conductive dielectric/thermal conductive substrate is separated into individual LED elements. Dielectric and electrodes/wirings are formed to complete the fabrication process of the LED array.

The LED fabrication process (a) through (c) mentioned above (release of thin film LED from GaAs layer, bonding

to the dielectric without adhesives) is referred to as the “epi film bonding” process.

## (2) Selecting a thermal conductive dielectric to bond with the thin film LED

Selection of the thermal conductive dielectric is a key factor in achieving the bonded structure between the thin film LED and thermal conductive dielectric/thermal conductive substrate using the aforementioned epi film bonding.

In order to use epi film bonding instead of adhesives to bond the thin film LED and thermal conductive dielectric/thermal conductive substrate, intermolecular forces are utilized on the surfaces of the thin film LED and thermal conductive dielectric. Intermolecular forces work when the proximity of neighboring molecules is in the order of nanometers. Therefore, to bond the thin film LED and thermal conductive dielectric together using intermolecular forces (intermolecular bonding), the smoothness of the dielectric surface is required to be in the order of nanometers. For this to be true, the thermal conductive substrate over which the dielectric surface is formed must possess nanometer-order smoothness. Thin film formed on the substrate cannot smooth out the surface of the substrate. The film will simply be reflective of the uneven substrate surface. Additionally, the material of the thermal conductive dielectric must be workable to form a nanometer-order smooth surface. On that basis, it is necessary to establish a technology for forming thermal conductive dielectrics with nanometer-order smoothness. This article will not touch on the technologies behind processing of thermal conductive substrate for nanometer-order smoothness or forming thermal conductive dielectrics with nanometer-order smooth surface. What it will discuss is the selection of a material that makes forming a nanometer-order smooth surface possible.

For film material that has high thermal conductivity and can be formed into a smooth surface, attention was focused on Diamond-Like Carbon (DLC). To test epi film bonding between the thin film LED and DLC film, a Si substrate was chosen as the thermal conductive substrate since it is commercially available with a nanometer-order smooth surface. After forming a DLC film over the Si substrate, thin film LED was bonded onto the DLC film.

DLC film approximately 100nm thick was formed on top of the Si substrate through Chemical Vapor Deposition (CVD), and the smoothness of the DLC film was evaluated using an Atomic Force Microscope (AFM). The result of the evaluation is shown in **Figure 3** (evaluated area:  $5\mu\text{m}$

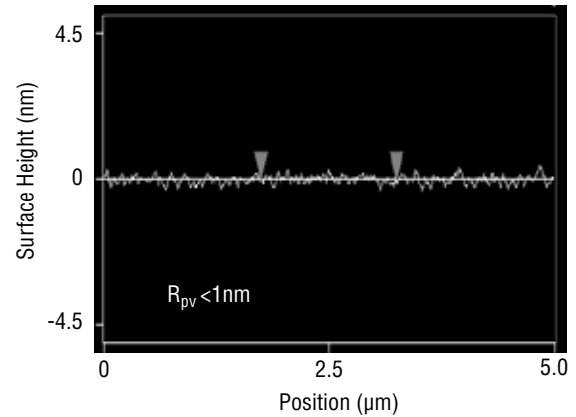

**Figure 3. Smoothness Measurement of the DLC Film Using AFM**

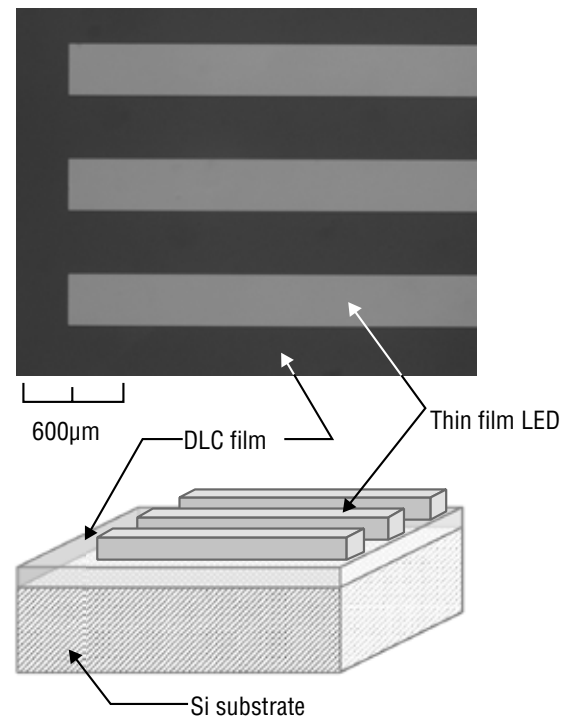
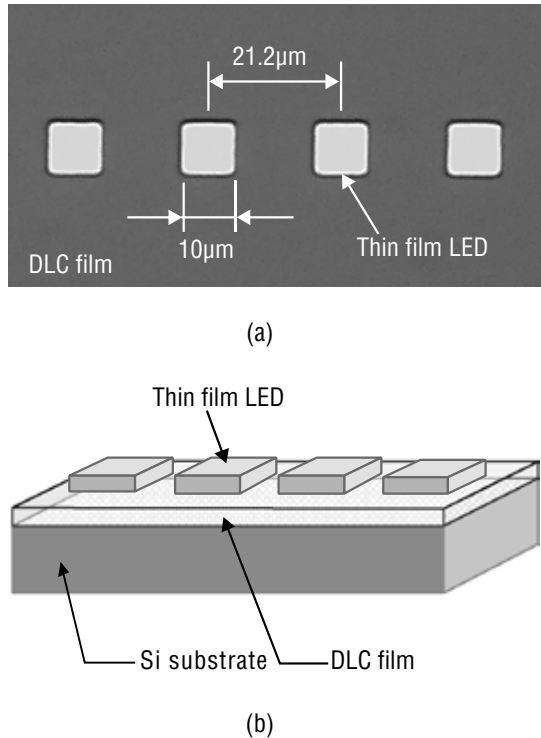

**Figure 4. Micrograph of Thin Film LED Strips (Width:  $300\mu\text{m}$ , Length: 1.3mm) Bonded to DLC Film/Si Substrate**

$\times 5\mu\text{m}$ ). As the **Figure 3** shows,  $R_{pv}$  (height difference of valleys) of the DLC film in the measurement area is about 1nm. From the point of smoothness, this DLC film can be considered well suited for intermolecular bonding.

Once the smoothness of the DLC film formed on the Si substrate was confirmed suitable for intermolecular bonding, thin film LED was bonded to the DLC film/Si substrate<sup>9)</sup>.

**Figure 4** is a micrograph of thin film LED strips (width: approximately  $300\mu\text{m}$ , length: approximately 1.3mm)

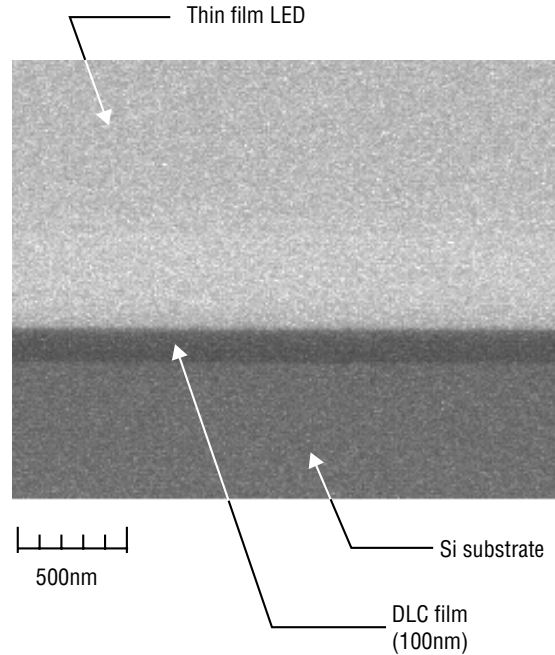

**Figure 5. (a): Micrograph of Thin Film LED Array Bonded to DLC Film/Si Substrate (Size:  $10\mu\text{m}\times 10\mu\text{m}$ , Pitch:  $21.2\mu\text{m}$ ) (b): Schematic Representation of Structure in (a)**

bonded to the DLC film/Si substrate. As can be seen in **Figure 4**, microscopic observation reveals the thin film LEDs are well bonded to the DLC film/Si substrate without any signs of peeling. To further test the bond, the thin film LED was processed into a  $10\mu\text{m}\times 10\mu\text{m}$  LED array with a pitch of  $21.2\mu\text{m}$  (pitch equivalent to 1,200 dpi density array). Processing of the LED array was performed using standard photolithographic process and etching process.

Micrograph of the  $10\mu\text{m}\times 10\mu\text{m}$  LED array with a pitch of  $21.2\mu\text{m}$  can be seen in **Figure 5 (a)**, and the schematic representation of the structure that appears in the micrograph is shown in **Figure 5 (b)**.

If the bonding between the thin film LED and DLC film is poor, chemical will permeate into the interface of the two films when the thin film LED is being processed, or the thin film LED will peel from the substrate due to thermal expansion during the heating process. The total bonding force working on a surface will decrease as the size of the bonding area is reduced therefore, smaller the size of the thin film LED bonding area, the more likely it will peel away from the DLC film/Si substrate. As can be seen in **Figure 5**, despite the small  $10\mu\text{m}\times 10\mu\text{m}$  size the thin film LEDs are well bonded to the DLC film/Si substrate. The fact that a



**Figure 6. Cross-sectional SEM Image of Thin Film LED Bonded to DLC Film/Si Substrate Using Epi Film Bonding**

strong bond is maintained between the processed thin film LEDs and DLC film/Si substrate without any signs of peeling or floating suggests the bonding forces worked well over the entire surface of thin film LED strip shown in **Figure 4**, and the thin film LED is solidly bonded to the DLC film/Si substrate.

To check the bond between the thin film LED and DLC film/Si substrate in further detail, electron microscopy images of the bonding area taken with a Scanning Electron Microscope (SEM) were observed. **Figure 6** is a cross-sectional SEM image of the thin film LED bonded to DLC film/Si substrate using epi film bonding. As **Figure 6** shows, no gaps are observed between the thin film LED and DLC film, and the thin film LED is firmly in contact with DLC film/Si substrate across the entire area of the SEM image. Traditionally, DLC film has been used to reduce friction or prevent bonding between surfaces. From this perspective, the first demonstration of applying DLC film for the opposite purpose, which is bonding of two surfaces, can be considered an invaluable accomplishment.

It has been proven that thin film LED can be bonded to DLC film/Si substrate without adhesives using epi film bonding. The use of DLC film with its high thermal conductivity will open the way for directly bonded thin film LED/DLC film/thermal conductive substrate structure that has high heat-dissipating characteristics.

## Characteristics of the Thin Film LED Bonded to DLC Film/Si Substrate

This section focuses on LED current to temperature ( $I_F$ - $T_{LED}$ ) characteristics and LED current to light ( $I_F$ - $P_{LED}$ ) characteristics of a 1,200dpi LED array fabricated from thin film LED bonded directly to DLC film/Si substrate using epi film bonding. Then it discusses the heat dissipation characteristics of the thin film LED/DLC film/Si substrate structure and the effect on  $I_F$ - $P_{LED}$ .

### (1) $I_F$ - $T_{LED}$ Characteristics

Following the process outline in **Figure 2**, strips of thin film LEDs are bonded to DLC film/Si substrate using epi film bonding, then the thin film LEDs are processed to fabricate a 1,200dpi LED array.

The luminous area of each LED is  $8\mu\text{m} \times 8\mu\text{m}$ . To compare the heat dissipation characteristics of the directly bonded LEDs, another 1,200dpi LED array ( $8\mu\text{m} \times 8\mu\text{m}$  luminous area) with a  $2\mu\text{m}$  thick polyimide (PI) layer placed between the thin film LED and DLC film/Si substrate was fabricated. PI is known to have low thermal conductivity.

**Figure 7** shows the  $I_F$ - $T_{LED}$  characteristics of the directly bonded LED array.  $T_{LED}$  was experimentally estimated from the nature of LED emission wavelength to vary with LED temperature.  $I_F$ - $T_{LED}$  characteristics of the LED array with the  $2\mu\text{m}$  PI layer are also shown in **Figure 7**. As can be seen in the figure, temperature rise resulting from increase in  $I_F$  was moderate on the directly bonded LED array. Even with  $I_F$  as high as 10mA, rise from room temperature was small at about  $30^\circ\text{C}$  demonstrating high dissipation of heat.  $I_F$  was further increased, but no rapid rise in temperature was observed. By contrast, LEDs bonded to the PI layer showed rapid rise in temperature as  $I_F$  was increased. At  $I_F = 10\text{mA}$ , the rise was extremely large reaching about  $180^\circ\text{C}$  above the room temperature. This is six times the temperature rise observed with the directly bonded LED array.

The above results verify that thin film LEDs bonded directly to DLC film/Si substrate possess high heat-dissipating characteristics, and temperature rise remains small even when LEDs are operated under large  $I_F$  conditions. Important point here is, what effect does achieving high LED heat dissipation have on LED luminous efficiency. The next section will look into the  $I_F$ - $P_{LED}$  characteristics of the directly bonded LED array.

### (2) $I_F$ - $P_{LED}$ Characteristics

$I_F$ - $P_{LED}$  characteristics of the directly bonded LED array are presented in **Figure 8**. For comparison, the figure

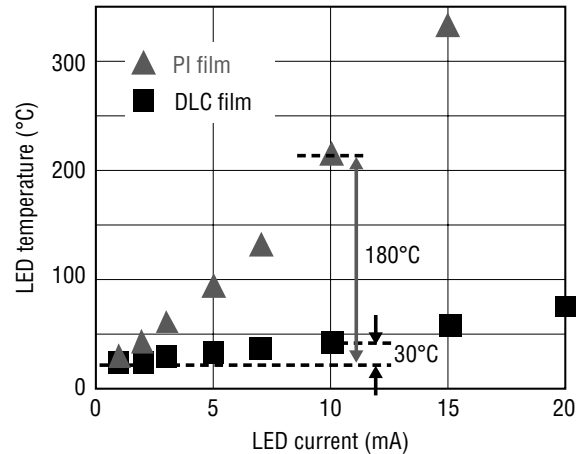

**Figure 7.  $I_F$ - $T_{LED}$  Characteristics of LED Bonded Directly to DLC Film/Si Substrate**

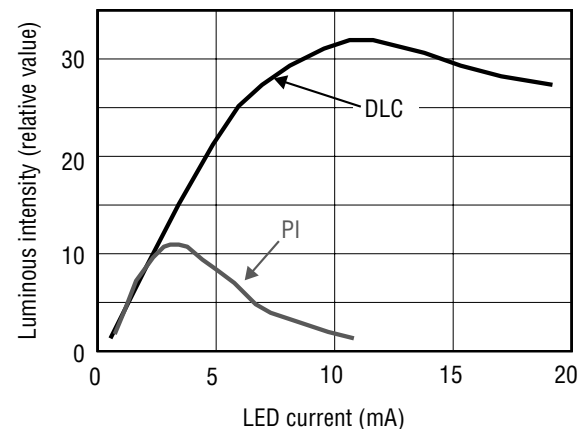

**Figure 8.  $I_F$ - $P_{LED}$  Characteristics of LED Bonded Directly to DLC Film/Si Substrate**

also shows  $I_F$ - $P_{LED}$  characteristics of the LED array with the  $2\mu\text{m}$  PI layer. For directly bonded LEDs, increase in  $P_{LED}$  is relatively proportional to the increase in  $I_F$  when  $I_F < 10\text{mA}$ . This is because LED temperature only rises a small amount when  $I_F$  is increased. On the other hand, the temperature rise of the PI-layered LED array is large as  $I_F$  increases. For this reason,  $P_{LED}$  begins to saturate as  $I_F$  approaches 3mA, and when  $I_F$  goes above 3mA,  $P_{LED}$  starts to decrease dramatically. The maximum luminous intensity (peak value of  $I_F$ - $P_{LED}$  characteristics curve) of the directly bonded LED array is three times the maximum of the PI-layered LED array. This verifies the high heat dissipation LED array fabricated from direct bonding of thin film LEDs to DLC film/Si substrate provides bright luminous intensity without losing luminous efficiency over a wide  $I_F$  operating range and therefore, maximizes LED output.

## Conclusion

During this technical development, it has been demonstrated for the first time that thin film LEDs can be directly bonded (intermolecular bonding) to DLC film formed on top of Si substrate without the use of adhesives. Additionally, the thin film LED on DLC film/Si substrate structure provides high heat dissipation enabling the LEDs to emit bright lights without decrease in luminous intensity even at high LED currents. This article covered the materials chosen for use on the LED print head and discussed a new technology to fabricate high heat dissipation LED array. This technology has the potential to be used in a wide variety of other applications that require high heat dissipation.

## Acknowledgments

Part of this technical development was carried out with the support of New Energy and Industrial Technology Development Organization (NEDO). ◆◆

## References

- 1) M. Ogihara, "Latest Trend of High Definition LED Printheads", OKI Technical Review No. 208, Vol. 73 No. 4, pp. 28-31, 2006
- 2) M. Ogihara, "Dissimilar Material Fusing Using Epi Film Bonding", OKI Technical Review No. 211, Vol.74 No.3, pp.98-103, 2007
- 3) M. Ogihara, T. Sagimori, M. Mutoh, H. Furuta, T.Suzuki, H. Fujiwara and M. Sakuta, "Single-Crystal Thin-Film Bonding on Diamond-Like Carbon Film by Intermolecular Force for Super High-Density Integration of High-Power LEDs", Abstracts of IEEE International Electron Device Meeting (IEDM) 2008, Dec. 15, 2008 - Dec. 17, 2008, San Francisco, CA, USA, pp. 477-480, 2008

## Authors

Tomohiko Sagimori, Development Division, OKI Digital Imaging Corporation

Masataka Muto, Development Division, OKI Digital Imaging Corporation

Hiroyuki Fujiwara, Team Leader, Development Division, OKI Digital Imaging Corporation

Mitsuhiko Ogihara, Director, Development Division, OKI Digital Imaging Corporation